Performance-Based Containment Leak-Test Program

Final Report

U.S. Nuclear Regulatory Commission

Office of Nuclear Regulatory Research

M. Dey/NRC

L. Skoblar, P. Chen, D. Goldin/SC&A
P. Cybulskis, L. Minton, S. Rose/Battelle
W. Roman/SPC



111

AVAILABILITY NOTICE

Availability of Reference Materials Cited in NRC Publications

Most documents cited in NRC publications will be available from one of the following sources:

1. The NRC Public Document Room, 2120 L Street, NW., Lower Level, Washington, DC 20555-0001
2. The Superintendent of Documents, U.S. Government Printing Office, P. O. Box 37082, Washington, DC 20402-9328
3. The National Technical Information Service, Springfield, VA 22161-0002

Although the listing that follows represents the majority of documents cited in NRC publications, it is not intended to be exhaustive.

Referenced documents available for inspection and copying for a fee from the NRC Public Document Room include NRC correspondence and internal NRC memoranda; NRC bulletins, circulars, information notices, inspection and investigation notices; licensee event reports; vendor reports and correspondence; Commission papers; and applicant and licensee documents and correspondence.

The following documents in the NUREG series are available for purchase from the Government Printing Office: formal NRC staff and contractor reports, NRC-sponsored conference proceedings, international agreement reports, grantee reports, and NRC booklets and brochures. Also available are regulatory guides, NRC regulations in the *Code of Federal Regulations*, and *Nuclear Regulatory Commission Issuances*.

Documents available from the National Technical Information Service include NUREG-series reports and technical reports prepared by other Federal agencies and reports prepared by the Atomic Energy Commission, forerunner agency to the Nuclear Regulatory Commission.

Documents available from public and special technical libraries include all open literature items, such as books, journal articles, and transactions. *Federal Register* notices, Federal and State legislation, and congressional reports can usually be obtained from these libraries.

Documents such as theses, dissertations, foreign reports and translations, and non-NRC conference proceedings are available for purchase from the organization sponsoring the publication cited.

Single copies of NRC draft reports are available free, to the extent of supply, upon written request to the Office of Administration, Distribution and Mail Services Section, U.S. Nuclear Regulatory Commission, Washington DC 20555-0001.

Copies of industry codes and standards used in a substantive manner in the NRC regulatory process are maintained at the NRC Library, Two White Flint North, 11545 Rockville Pike, Rockville, MD 20852-2738, for use by the public. Codes and standards are usually copyrighted and may be purchased from the originating organization or, if they are American National Standards, from the American National Standards Institute, 1430 Broadway, New York, NY 10018-3308.

Performance-Based Containment Leak-Test Program

Final Report

Manuscript Completed: July 1995
Date Published: September 1995

M. Dey/NRC

L. Skoblar, P. Chen, D. Goldin/SC&A¹
P. Cybulskis, L. Minton, S. Rose/Battelle²
W. Roman/SPC³

**Division of Regulatory Applications
Office of Nuclear Regulatory Research
U.S. Nuclear Regulatory Commission
Washington, DC 20555-0001**



¹S. Cohen & Associates, Inc., 1355 Beverly Road, Suite 250, McLean, VA 22101

²Battelle, 505 King Avenue, Columbus, OH 43201

³Southwest Power Consultants, Inc., 4935 E. Rancho Del Oro Drive, Cave Creek, AZ 85331

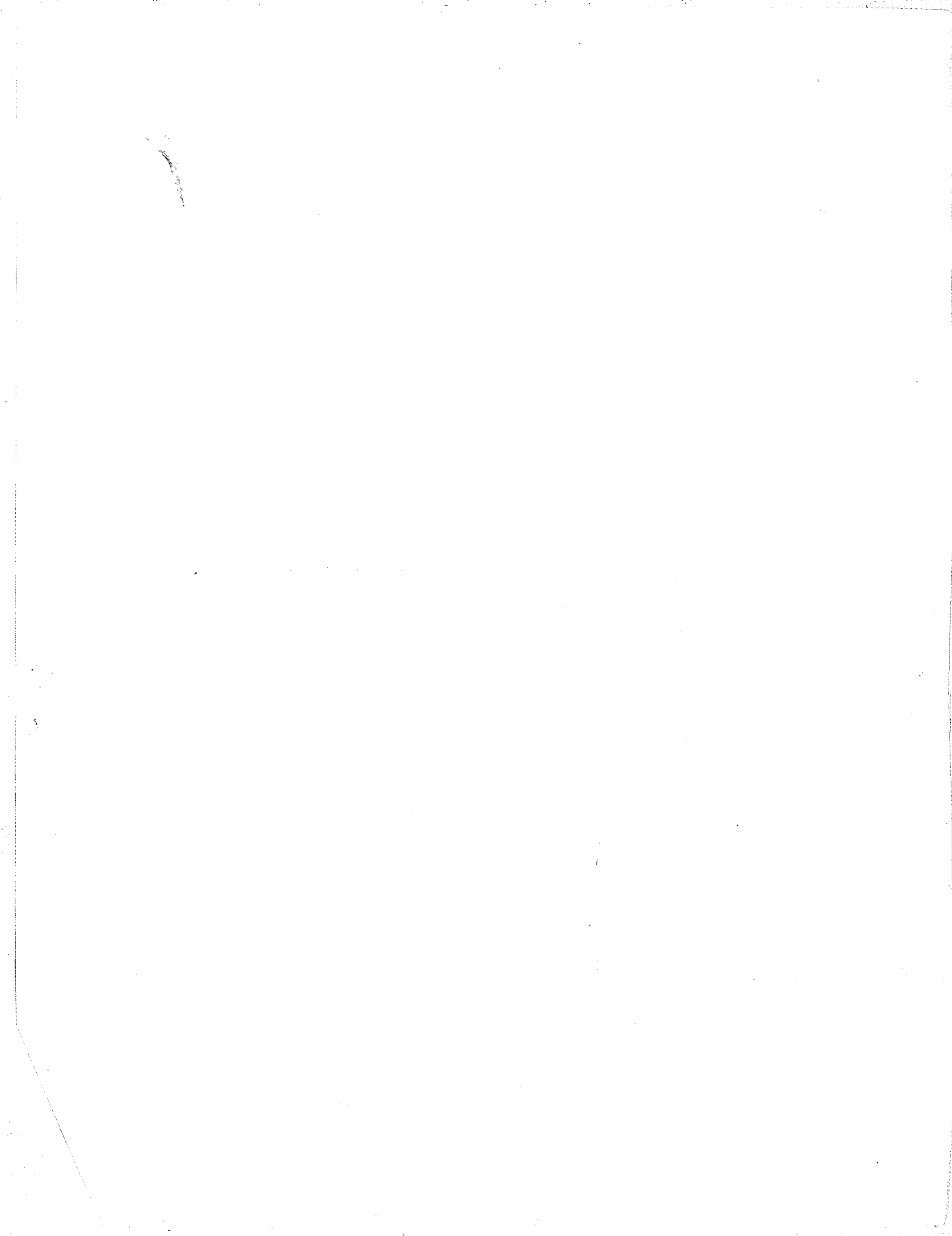

ABSTRACT

This technical support document (TSD) describes the NRC's current regulatory requirements and the experiences of utilities (foreign and domestic) in conducting tests for identifying leakage in nuclear reactor containment structures. The risk impacts of nuclear reactor containment leak-tightness are analyzed, as are the cost and risk of the current requirements (base case) and the alternatives considered, including longer intervals between containment leak tests, and an increase in the allowable leakage rate from the containment. In addition, an alternative requiring continuous on-line monitoring of containment integrity is considered. Analytical uncertainties are addressed.

The present study makes the following findings:

- **Leakage Rates** - Confirms previous observations of insensitivity of population risks from severe reactor accidents to containment leakage rates at low levels; the allowable leakage rate can be increased by one to two orders of magnitude without significantly impacting the estimates of population dose risk in the event of an accident; and, an increase in the allowable leakage rate reduces the remaining costs of leak testing by about 10 percent.
- **Type A Tests** - A reduction in the frequency of tests from the current three per 10 years to one per 10 years leads to an imperceptible increase in risk and would eliminate about 83 percent of remaining costs.
- **Types B and C Tests** - A reduction in the frequency of Type B testing of electrical penetrations should be possible with no adverse impact on risk; the vast majority of leakage paths are identified by LLRTs of containment isolation valves (Type C tests) and, based on the model of component failure with time, performance-based alternatives to current local leakage-testing requirements are feasible without significant risk impacts; and, about 58 percent of the costs of LLRTs could be eliminated by a performance-based method.
- **On-Line Monitoring** - Continuous monitoring methods exist that appear technically capable of detecting leaks in reactor containments within one day to several weeks, but cannot be considered as a complete replacement for Type A tests and cannot be justified solely on risk considerations.

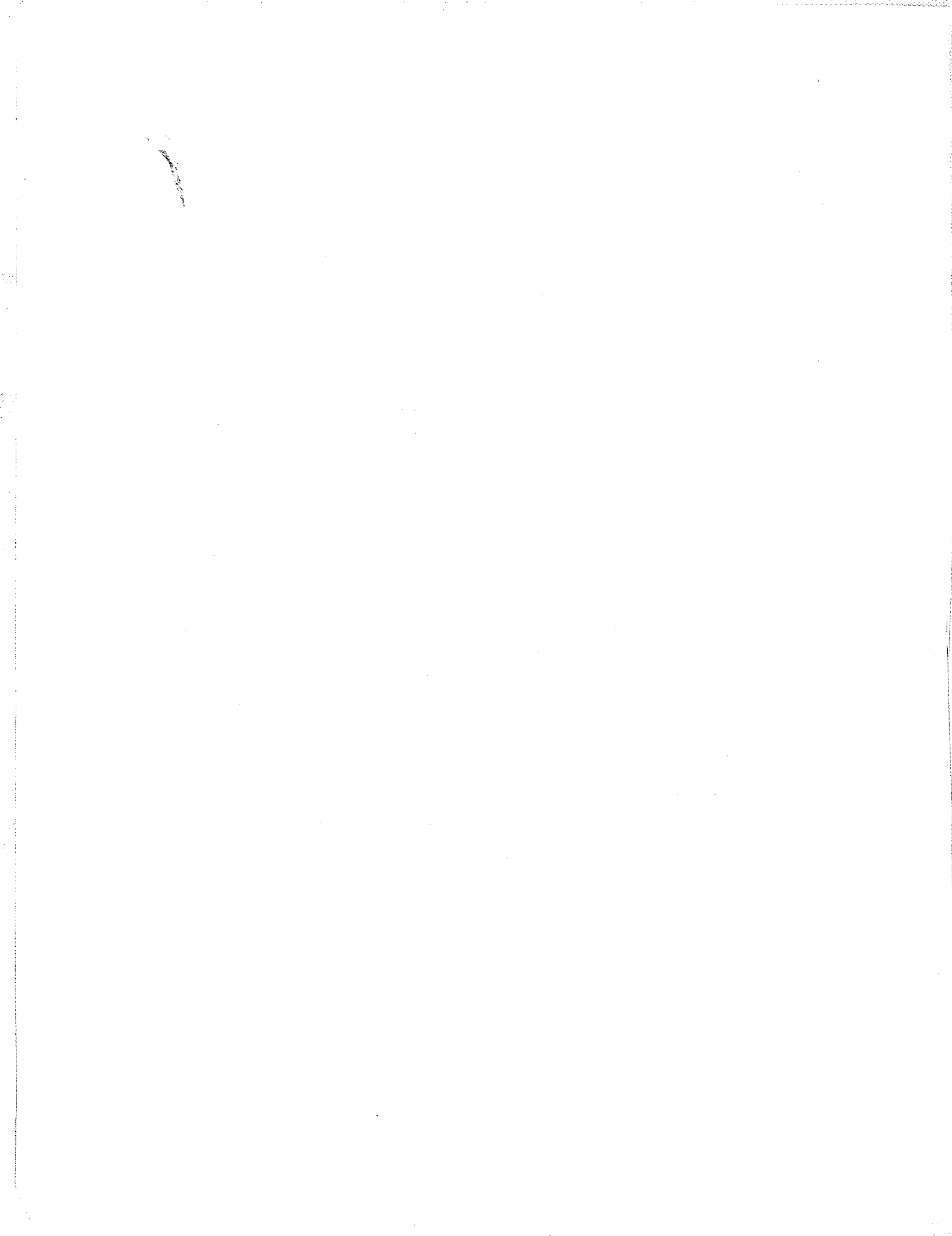

Contents

	<u>Page</u>
1. Introduction	1-1
1.1 Statement of the Problem	1-1
1.2 Background	1-1
1.3 Objectives and Scope	1-4
2. Current Regulatory Requirements	2-1
2.1 Leak-Tightness Requirements	2-1
2.2 Test Frequency Requirements	2-2
2.3 Documentation	2-3
3. Containment Leakage-Rate Test Methods	3-1
3.1 Typical Test Methods	3-1
3.1.1 Type A Tests	3-1
3.1.2 Type B Tests	3-3
3.1.3 Type C Tests	3-3
3.1.4 Test Instruments	3-3
3.2 Alternative Approaches	3-5
3.2.1 The Belgian Approach	3-8
3.2.2 The French Approach	3-9
3.2.3 The Canadian Approach	3-11
3.2.4 Discussion	3-12
4. Leakage-Rate Test Experience	4-1
4.1 Type A ILRT	4-1
4.2 Type B LLRT	4-4
4.3 Type C LLRT	4-7
4.4 Performance Trends	4-10
5. Risk Impacts of Containment Leak-tightness	5-1
5.1 Review of Earlier Work on Risk Impacts of Containment Leakage Rate - NUREG/CR-4330	5-1
5.1.1 Existing PRAs	5-1
5.1.2 Selected Accident Scenarios	5-3
5.1.3 TMI-Related Scenario	5-4
5.1.4 Conclusions Reached in NUREG/CR-4330	5-4
5.2 Risk Impacts	5-4
5.2.1 Approach	5-4
5.2.2 Results	5-6
5.2.2.1 Surry	5-6
5.2.2.2 Peach Bottom	5-8
5.2.2.3 Sequoyah	5-8
5.2.2.4 Grand Gulf	5-9
5.2.2.5 Zion	5-9

Contents (Continued)

	<u>Page</u>
5.2.2.6 Discussion	5-9
5.2.3 Comparison with Earlier Results	5-11
5.2.4 Discussion of Uncertainties	5-12
6. Alternatives	6-1
6.1 Integrated Leakage-Rate (Type A) Tests	6-1
6.2 Local Leakage-Rate (Type B & C) Tests	6-2
6.3 On-line Monitoring	6-4
6.4 Performance-Based Alternatives	6-4
7. Risk Impacts of Alternative Appendix J Requirements	7-1
7.1 Qualitative Considerations	7-1
7.2 Quantitative Impacts	7-2
7.2.1 Risk Impacts on the Public	7-6
7.2.2 Risk Impacts on Occupational Exposure	7-11
8. Cost Incurred in Meeting Appendix J Requirements	8-1
8.1 Summary of Data Reported in Earlier Studies and by Industry	8-1
8.2 Current Study Cost Analysis	8-2
8.2.1 Cost of Type B & C Tests (LLRTs) - Current Appendix J Requirements	8-2
8.2.2 Costs of Type A Tests (ILRTs) - Current Appendix J Requirements	8-3
8.2.3 Effects of Relaxing the Acceptance Criteria on ILRT and LLRT Costs	8-3
8.2.4 Effects of Reducing the Frequency of ILRTs and LLRTs on Utility Costs	8-4
8.2.5 Estimates of Baseline and Alternative Costs	8-4
9. Uncertainties	9-1
9.1 Uncertainties in Risk Perspective	9-1
9.2 Uncertainties in Cost Perspective	9-2
10. Summary of Technical Findings	10-1
10.1 Risk	10-1
10.1.1 Significance of Containment Leak Rates	10-1
10.1.2 Leak-Testing Intervals	10-1
10.1.3 Allowable Leak Rate	10-3
10.1.4 On-Line Monitoring Systems	10-4
10.2 Cost	10-4
References	R-1
Glossary	G-1

Contents (Continued)

	<u>Page</u>
Appendix A - Analysis of Type B/C Leak-Rate History	A-1
Appendix B - Approach to Assessing Risk Impacts	B-1
Appendix C - Canadian and European OLM and Type A Tests	C-1
Appendix D - Detailed Cost Estimates for 20- and 40-Year Baselines and Alternatives	D-1
Appendix E - Dependence of Environmental Source Terms on Containment Leakage	E-1
Appendix F - Grand Gulf Nuclear Station - Local Leakage-Rate Test Program	F-1

Tables

<u>Number</u>		<u>Page</u>
3-1	Characteristics of On-line Monitoring Methods	3-7
4-1	Examples of Failed ILRTs	4-2
4-2	Type A Performance Test Data	4-5
4-3	Grand Gulf Type B Performance Test Data	4-7
4-4	NUMARC Type B Performance Test Data	4-8
4-5	Grand Gulf Type C Performance Data	4-10
4-6	Type C Valves Exceeding Administrative Limits	4-11
4-7	NUMARC Type C Performance Data	4-12
5-1	Risk Information Summary	5-2
5-2	Dependence of Risk on Containment Leakage Rate	5-3
5-3	Definitions of Consequence Analysis Results	5-5
5-4	Summary of Risk Analysis Results	5-7
5-5	Comparison of Source Terms	5-10
5-6	Comparison of Results	5-11
6-1	Alternatives	6-7
8-1	Baseline: 20-Year Test Cycle - No License Extensions Current Appendix J Requirements	8-7
8-2	Baseline: 40-Year Test Cycle - 20-Year License Extensions Current Appendix J Requirements	8-8
8-3	Summary of Industry-Wide Costs - 20-Year Baseline and Alternatives, 5-percent Discount	8-9
8-4	Summary of Industry-Wide Costs - 20-Year Baseline and Alternatives, 10-percent Discount	8-10

Tables (Continued)

<u>Number</u>		<u>Page</u>
8-5	Summary of Industry-Wide Costs - 40-Year Baseline and Alternatives, 5-percent Discount	8-11
8-6	Summary of Industry-Wide Costs - 40-Year Baseline and Alternatives, 10-percent Discount	8-12
10-1	Summary of Risk Impacts of Alternatives	10-2
10-2	Summary of Industry-Wide Cost Savings	10-6

Figures

<u>Number</u>		<u>Page</u>
5-1	Sensitivity of Risk to Containment Leakage Rate	5-14
5-2	Population Exposure as Function of Containment Leakage Rate for Surry	5-15
5-3	Total Latent Cancer Risk as Function of Containment Leakage Rate for Surry	5-16
5-4	Individual Latent Cancer Risk as Function of Containment Leakage Rate for Surry	5-17
5-5	Comparison of Individual Latent Cancer Risk for Surry with NRC Safety Goal	5-18
5-6	Population Exposure as Function of Containment Leakage Rate for Peach Bottom	5-19
5-7	Total Latent Cancer Risk as Function of Containment Leakage Rate for Peach Bottom	5-20
5-8	Individual Latent Cancer Risk as Function of Containment Leakage Rate for Peach Bottom	5-21
5-9	Comparison of Individual Latent Cancer Risk for Peach Bottom with NRC Safety Goal	5-22
5-10	Population Exposure as Function of Containment Leakage Rate for Sequoyah	5-23
5-11	Total Latent Cancer Risk as Function of Containment Leakage Rate for Sequoyah	5-24
5-12	Individual Latent Cancer Risk as Function of Containment Leakage Rate for Sequoyah	5-25
5-13	Comparison of Individual Latent Cancer Risk for Sequoyah with NRC Safety Goal	5-26
5-14	Population Exposure as Function of Containment Leakage Rate for Grand Gulf	5-27
5-15	Total Latent Cancer Risk as Function of Containment Leakage Rate for Grand Gulf	5-28
5-16	Individual Latent Cancer Risk as Function of Containment Leakage Rate for Grand Gulf	5-29
5-17	Comparison of Individual Latent Cancer Risk for Grand Gulf with NRC Safety Goal	5-30

Figures (Continued)

<u>Number</u>		<u>Page</u>
5-18	Population Exposure as Function of Containment Leakage Rate for Zion	5-31
5-19	Total Latent Cancer Risk as Function of Containment Leakage Rate for Zion . .	5-32
5-20	Individual Latent Cancer Risk as Function of Containment Leakage Rate for Zion	5-33
5-21	Comparison of Individual Latent Cancer Risk for Zion with NRC Safety Goal .	5-34
5-22	Uncertainties Associated with Latent Cancer Risks in NUREG-1150 and WASH-1400	5-35
7-1	Sensitivity of Risk to Containment Leakage	7-13
7-2	Comparison of Individual Latent Cancer Risks with NRC Safety Goal	7-14

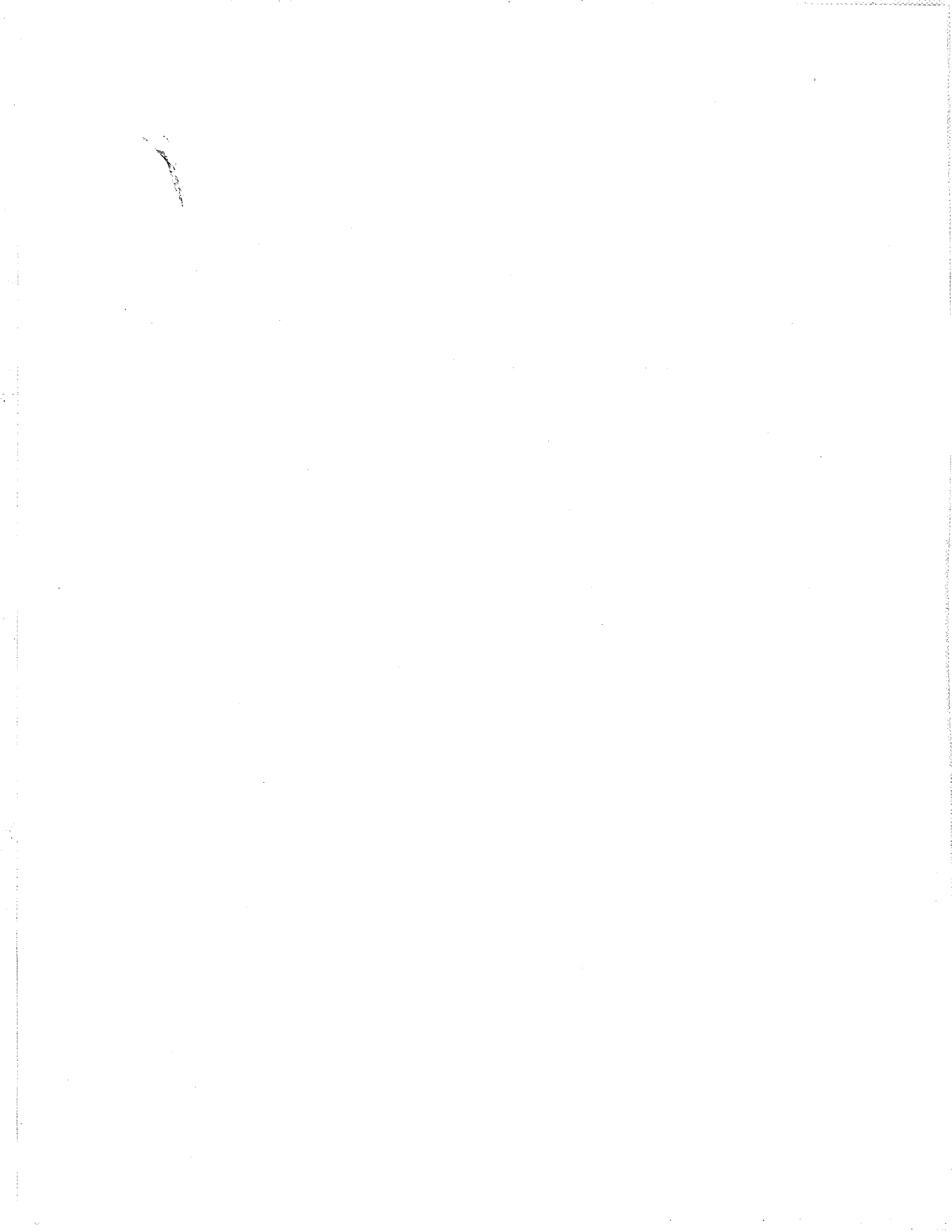

PREFACE

The Nuclear Regulatory Commission (NRC) is implementing an initiative to eliminate requirements that are marginal to safety and yet impose a significant regulatory burden on licensees. The containment leakage-testing requirements for power reactors have been identified as one area where performance-based requirements could replace the current prescriptive requirements with only a marginal impact on safety. This technical support document (TSD) provides the technical bases for the NRC's rulemaking to revise leakage-testing requirements for nuclear power reactors in 10 *CFR* Part 50, Appendix J.

This report identifies alternatives to current containment testing requirements which would meet the NRC's Safety Goals and achieve greater efficiency in the use of resources. Changes in the allowable leakage rate for containment and the testing frequencies for both integrated and local leakage-rate tests are evaluated in terms of both risk and cost impacts. The feasibility of applying statistically-based sampling techniques to local leakage-rate testing, and the use of on-line monitoring systems to continuously monitor containment integrity are also evaluated.

Public comments on draft NUREG-1493, which was published in January 1995, were received and have been addressed. The comment analysis and resolution is included in a Public Comment Resolution Document for the rulemaking which is available for inspection and/or copying in the NRC Public Document Room, located at 2120 L Street, NW. (lower level), Washington, DC.

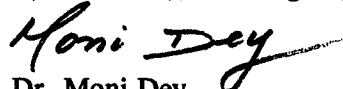
Dr. Moni Dey

Office of Nuclear Regulatory Research
U.S. Nuclear Regulatory Commission
Washington, DC 20555

ACKNOWLEDGEMENTS

The Nuclear Regulatory Commission has received information and data from a number of sources for the conduct of this study. This information has been very useful to provide a broad coverage of testing methods and practices, and allowed detailed analysis of data. The NRC is grateful to personnel from the Nuclear Energy Institute and its members, Virginia Electric Power Company and Entergy Operations, for providing data used for the analyses presented in this study. The NRC is also grateful to personnel from the Institute of Protection and Nuclear Safety of the Atomic Energy Commission, Electricite de France, and the Directorate for the Safety of Nuclear Installations in the Ministry of Industry and Commerce in France; the Swedish Nuclear Inspectorate (SKI) and Vattenfall AB in Sweden; AIB Vincotte Nuclear and Tractabel in Belgium; and Hydro Quebec in Canada for providing information on their containment leakage testing practices and methods which are summarized in this study.

1. Introduction

This technical support document (TSD) provides the technical bases for the Nuclear Regulatory Commission's (NRC) rulemaking to revise leakage-testing requirements in 10 *CFR* Part 50, Appendix J.

The TSD has 10 chapters. Chapter 2 describes the current regulatory requirements for leakage testing of nuclear reactor containment structure. Chapter 3 describes the leakage tests conducted by utilities to demonstrate compliance with Appendix J. Chapter 4 describes experiences utilities have had in complying with Appendix J requirements since they were first enacted in 1973. The risk impacts of nuclear reactor containment leak-tightness are analyzed in Chapter 5. Potential alternatives to the current NRC requirements are introduced in Chapter 6. Chapters 7 and 8 present the analyses of cost and risk, respectively, of the current requirements (base case) and the alternatives considered. Analytical uncertainties are addressed in Chapter 9. Chapter 10 summarizes the technical findings. A glossary, a list of references, and five appendices are provided at the end of the TSD.

1.1 STATEMENT OF THE PROBLEM

The NRC is in the process of reviewing current regulatory requirements in an effort to relax or eliminate requirements that are marginal to safety and yet impose a significant regulatory burden on licensees. Reactor containment leakage testing has been identified as an area where the NRC is proposing a change in regulations.

Technical studies have consistently shown that design basis containment leakage is a relatively minor contributor to reactor accident risk. Reactor accident risk is dominated by accidents in which the containment fails or is bypassed (NRC75, NRC86, NRC90). Therefore, modifying the containment leakage rate and/or test frequency is not expected to have a significant impact on reactor accident risk.

1.2 BACKGROUND

General

The NRC published a notice in the *Federal Register* on February 4, 1992, (57 *FR* 4166), presenting its planned initiative to begin eliminating requirements that are marginal to safety and yet impose significant regulatory burdens on licensees. In this continuing effort, the NRC will analyze existing regulations to eliminate or relax burdens on licensees when the burdens are not commensurate with the safety significance of the regulations.

In the February 1992 *Federal Register* notice, the NRC concluded that decreasing the prescriptiveness of some regulations could increase their effectiveness by giving the licensees the flexibility to implement more cost-effective safety measures. The regulatory process could also be made more efficient.

To increase flexibility, the detailed and prescriptive technical requirements contained in some regulations could be improved and replaced with performance-based requirements and supporting regulatory guides. The regulatory guides would allow alternative approaches, although compliance with current detailed regulatory requirements would still be acceptable. The performance-based requirements would reward superior operating practices.

In eliminating requirements marginal to safety, the NRC plans to utilize its safety goals and probabilistic risk assessment (PRA) tools (51 *FR* 28044), to the extent deemed appropriate, in the development of performance-based regulations, and in the review and development of regulations.

The NRC also plans to evaluate and assess the usefulness of alternative containment testing approaches to minimize the probability of undetected gross openings in the containment structure.

Introduction

In the near-term, the NRC is considering amending its requirements in three specific areas: 1) containment leakage testing, 2) fire prevention, and 3) quality assurance. This report addresses the first of these areas, containment leakage testing. Specifically, the NRC proposes to amend Appendix J of 10 *CFR* Part 50, "Primary Reactor Containment Leakage Testing for Water-Cooled Power Reactors," as its first effort to decrease unnecessary regulatory burdens on licensees.

Appendix J

Containment leakage testing has been identified as an area in which regulations could be made more performance oriented. The primary safety objective in this area has been, and continues to be, containment integrity. However, information on reactor accident risks derived from probabilistic risk assessments indicates that the currently allowable containment leakage rates can be increased without significantly affecting accident risk. While availability and reliability of containment integrity are important, the extremely low leakage rates prescribed by current regulations and the testing measures taken to assure these extremely low leakage rates may not be warranted. Reactor accident risk is dominated by low-probability, high-consequence scenarios in which the containment is failed or bypassed. In these types of accidents, there is little benefit derived from a high degree of containment leak-tightness.

Economic and occupational exposure costs are directly related to the frequency of containment testing. Containment integrated leakage-rate tests (Type A) by their nature preclude any other reactor maintenance activities and thus are on the critical path for return to service from reactor outages. In addition to the costs of the tests themselves, integrated leakage tests impose the added burden of the cost of replacement power. Containment penetration leakage tests (Type B and C) can be conducted during reactor shutdowns without interfering with other

activities and thus tend to be less onerous; however, the typically large number of penetrations impose a substantial burden on the utilities (NRC93B).

In the *Federal Register* published on January 27, 1993 (58 *FR* 6196), the NRC listed the following potential modifications to Appendix J of 10 *CFR* Part 50:

- Increase allowable containment leakage rates based on safety goals and PRA technology (i.e., define a new performance standard).
- Modify Appendix J to be a performance-based regulation:
 - Limit the revised rule to a new regulatory objective: In order to ensure the availability of the containment during postulated accidents, licensees should either:
 - test overall containment leakage at intervals not longer than every 10 years, and test pressure-containing or leakage-limiting boundaries and containment isolation valves on an interval based on the performance history of the equipment; or
 - provide an on-line (i.e., continuous) monitoring capability of containment isolation status.
 - Move details of the tests and reporting in Appendix J to a NRC regulatory guide as guidance.
 - Endorse industry standards on:
 - Guidance for calculating unit-specific allowable leakage rates based on the new NRC performance standard;

- Guidance on the conduct of containment tests; and
- Guidance for on-line monitoring of containment isolation status.
- Continue to accept compliance with the current detailed requirements in Appendix J (i.e., licensees presently in compliance with Appendix J will not need to do anything if they do not wish to change their practice).

The NRC held a public workshop on the subject on April 27, 1993 (NRC93B). As a starting point for discussions at the workshop, the NRC suggested the following preliminary criteria:

- Revised rules will focus on establishing the regulatory/safety objective in an objective manner. The main objective of a performance-based regulatory approach is to permit licensees the flexibility to use cost-effective methods for achieving the regulatory objectives.
- The regulatory objective will be derived, to the extent feasible, from risk considerations and within the framework of the NRC's safety goals.
- Detailed technical methods for measuring or judging the acceptability of a licensee's performance relative to the regulatory objectives will be provided in NRC regulatory guides. To the extent possible, approved industry standards and guidance will be endorsed in this regard.
- The new rules will be optional for current licensees and thus licensees can decide to remain in compliance with current regulations.
- A performance-based regulatory approach should provide incentives for innovation and improvements in safety.

- The following issues with regard to the proposed rulemaking activities need to be addressed in the process:
 - Can the new rule and its implementation yield an equivalent level of, or only have a marginal impact on, safety?
 - Can the regulatory/safety objective (qualitative or quantitative) be established in an objective manner to allow a common understanding between licensees and the NRC on how the performance or results will be measured or judged?
 - Can the regulation and implementation documents be developed in such a manner that they can be objectively and consistently inspected and enforced against?

NRC Safety Goals

In its response to the recommendations of the President's Commission on the Accident at Three Mile Island, the NRC stated that it was prepared to move forward with an explicit policy statement on safety philosophy and the role of safety-cost tradeoffs in its safety decisions. The NRC published its policy statement on "Safety Goals for the Operation of Nuclear Power Plants" on August 4, 1986 (51 *FR* 28044) (NRC86C).

The NRC's program to eliminate requirements that are marginal to safety derives from the NRC's desire to assess the consistency of the present regulations with the Commission's safety goals.

The NRC established two qualitative goals supported by two quantitative objectives based on the principle that nuclear risks should not be a significant addition to other societal risks.

Introduction

The qualitative goals are as follows:

- *Individual members of the public should be provided a level of protection from the consequences of nuclear power plant operation such that individuals bear no significant additional risk to life and health.*
- *Societal risks to life and health from nuclear power plant operation should be comparable to or less than the risks of generating electricity by viable competing technologies and should not be a significant addition to other societal risk.*

The following quantitative goals are used in determining achievement of the qualitative safety goals:

- *The risk to an average individual in the vicinity of a nuclear power plant of prompt fatalities that might result from reactor accidents should not exceed one-tenth of one percent (0.1 percent) of the sum of prompt fatality risks resulting from other accidents to which members of the U.S. population are generally exposed.*
- *The risk to the population in the area near a nuclear power plant of cancer fatalities that might result from nuclear power plant operation should not exceed one-tenth of one percent (0.1 percent) of the sum of cancer fatality risks resulting from all other causes.*

The NRC uses its safety goals as a means to gauge the adequacy of regulatory decisions regarding changes to current regulations.

On-Line Monitoring (OLM)

In its TMI Action Plan (NUREG-0660), the NRC raised the safety issue of there being unknown gross openings in the containment structure. This issue stems from a 1979 discovery that two 3-inch containment exhaust bypass valves at one nuclear unit had been

unknowingly locked at the open position while the reactor was operated. This situation persisted for about 1.5 years. Because of this and other similar incidents, the NRC undertook a series of studies of containment isolation history to evaluate alternate leakage-detection methods. The results of these studies are provided in NUREG-1273 (NRC88). The following summarizes the technical findings from NUREG-1273:

- Methods exist that appear practical and sufficiently sensitive to be of use for continuous leakage monitoring.
- OLMs do not have the accuracy of Type A testing but seem to offer enough accuracy and speed of detection to justify their use.
- The current program of Type A, B and C tests can detect all UBCIs (undetected breaches of containment isolation which may occur in the interval between Type A tests). Supplemental use of OLM will not detect additional UBCIs.
- OLM should not be considered as a complete replacement for Type A tests.
- There is no risk justification for imposing OLM. The estimated contribution of undetected leaks to the total risk associated with other containment failure modes in a severe accident is in the range of less than 0.5 percent to 3 percent.

1.3 OBJECTIVES AND SCOPE

This report identifies alternatives to current containment testing requirements which would meet the NRC's safety goals and achieve greater efficiency in the use of resources. For each alternative, risk and cost impact analyses are performed and the results documented. Thus, this report provides the technical bases for defining new containment leakage-testing requirements that would provide a balanced

consideration of the following characteristics. The new regulation should:

- provide comparable assurance that containment integrity will be maintained without significantly affecting public risk;
- give flexibility to the licensees in implementing cost-effective safety measures;
- be performance-based, i.e., provide balance and should reward good performers; and
- utilize safety goals and PRA tools to the extent possible.

To accomplish its objectives, this work evaluates changes in the allowable leakage rate for containment and the testing frequencies of both integrated and local leakage tests, application of statistically-based sampling techniques to local leakage-rate tests, and the use of systems that continuously monitor containment integrity (referred to as on-line monitoring).

The scope of the present study includes considerations of the effect of containment leakage on reactor accident risk, economic and

occupational exposure costs of existing and alternate containment leakage-testing requirements, the historical experience with containment performance, and the use of on-line monitoring of containment isolation as an alternative or supplement to periodic containment leakage testing. The effects of containment leakage on reactor accident risk have been previously examined; the present study reviews earlier efforts and updates them based on more recent probabilistic risk results, notably those developed in NUREG-1150 (NRC90). The details of these analyses are presented in Chapter 5.

The ability of the several kinds of tests (Types A, B and C) to assure containment integrity is assessed, and the historical experience with containment performance is examined. This provides a data base for extrapolating the possible impacts of revised regulations.

On-line monitoring of containment isolation performance has been suggested as a means of providing continuous indication of containment integrity. Earlier studies of on-line monitoring proposals are reviewed in light of the current effort, and potential benefits are assessed.



2. Current Regulatory Requirements

The regulatory objective of reactor containment design is stated in 10 *CFR* Part 50, Appendix A, "General Design Criteria for Nuclear Power Plants," Criterion No. 16, "Containment Design." Criterion 16 mandates "an essentially leak-tight barrier against the uncontrolled release of radioactivity to the environment ..." for postulated accidents.

Appendix J to 10 *CFR* Part 50 implements, in part, General Design Criterion No. 16 and specifies containment leakage-testing requirements, including the types of tests required. For each type of test required, Appendix J specifies the leakage-rate acceptance criteria, how such tests should be conducted, the frequency of testing, and reporting requirements. Appendix J requires the following types of containment leakage tests:

- Measurement of the containment integrated leakage rate (Type A tests, often referred to as ILRTs)
- Measurement of the leakage rate across each pressure-containing or leakage-limiting boundary for various primary reactor containment penetrations (Type B tests)
- Measurement of containment isolation valve leakage rates (Type C tests)

Type B and C tests are referred to as local leakage-rate tests (LLRTs).

2.1 LEAK-TIGHTNESS REQUIREMENTS

Compliance with 10 *CFR* Part 50, Appendix J, requirements is determined by comparing the measured containment leakage rate with the maximum allowable leakage rate. Appendix J does not specify how to quantify the maximum allowable leakage rate; instead, it refers to a unit's technical specifications or its operating license.

Maximum allowable leakage rates are calculated in accordance with 10 *CFR* Part 100, "Reactor Site Criteria," and are incorporated into the technical specifications. Paragraph 100.11 requires the calculation of the exclusion area, low population zone, and population center distance. The maximum allowable containment leakage rate is derived from such calculations, an assumed fission product release from the reactor core, and the meteorological conditions of the site, to satisfy the following criteria:

- An exclusion area of such size that an individual located at any point on its boundary for two hours immediately following onset of the postulated fission product release would not receive a total radiation dose to the whole body in excess of 25 rem or a total radiation dose in excess of 300 rem to the thyroid from iodine exposure.
- A low population zone of such size that an individual located at any point on its outer boundary who is exposed to the radioactive cloud resulting from the postulated fission product release (during the entire period of its passage) would not receive a total radiation dose to the whole body in excess of 25 rem or a total of 300 rem to the thyroid from iodine exposure.
- A population center distance of at least one and one-third times the distance from the reactor to the outer boundary of the low population zone. In applying this guide, the boundary of the population center shall be determined upon consideration of population distribution.

For those sites with multiple reactor facilities, additional requirements are specified in 10 *CFR* Part 100.

The fission product release assumed for the above calculations is based upon a major

Requirements

accident, hypothesized for purposes of site analysis or postulated from consideration of possible accidental events, that would result in potential hazards not exceeded by those from any accident considered credible. Such accidents have generally been assumed to result in substantial meltdown of the core with subsequent release of appreciable quantities of fission products (AEC62).

The "expected demonstrable leakage rate from containment" from the above analysis becomes the upper limit on the allowable containment leakage rate for the unit. In practice, a value lower than that required to meet the 10 *CFR* Part 100 limits is written into the unit's technical specifications. Typical allowable leakage rates are 0.1 percent of containment volume per day for pressurized water reactors (PWRs) and 1 volume percent per day for boiling water reactors (BWRs).

2.2 TEST FREQUENCY REQUIREMENTS

A schedule for conducting containment leakage-rate tests (both preoperational and periodic) is specified in Appendix J to 10 *CFR* Part 50.

The preoperational leakage-rate tests are conducted when construction of the reactor containment structure is complete and all parts of the mechanical, fluid, electrical, and instrumentation systems penetrating the containment structure have been installed.

Periodic leakage-rate tests schedules are as follows:

Type A Test

After the preoperational leakage-rate test, a set of three Type A tests shall be performed at approximately equal intervals during each 10-year service period. The third test of each set shall be conducted when the unit is shut down for the 10-year in-service inspection.

Type A tests shall be performed only during periods when the unit is nonoperational and secured in the shutdown condition under the administrative control and in accordance with the safety procedures defined in the license.

If any periodic Type A test fails to meet the applicable acceptance criteria, the test schedule applicable to subsequent Type A tests will be reviewed and approved by the Commission. If two consecutive periodic Type A tests fail to meet the applicable acceptance criteria, a Type A test shall be performed at each shutdown for refueling or approximately every 18 months, whichever occurs first, until two consecutive Type A tests meet the acceptance criteria, after which time the regular retest schedule may be resumed.

Type B Test

Except for air-locks, Type B tests shall be performed during reactor shutdown for refueling, or at other convenient intervals, but in no case at intervals greater than 2 years. If opened following a Type A or B test, containment penetrations subject to Type B testing shall be tested prior to returning the reactor to an operating mode requiring containment integrity. For primary reactor containment penetrations employing a continuous leakage-monitoring system, Type B tests, except for tests of air-locks, may be performed during every other reactor shutdown for refueling but in no case at intervals greater than 3 years.

Air-locks shall be tested prior to initial fuel loading and at 6-month intervals thereafter. Air-locks opened during periods when containment integrity is not required by the unit's technical specifications shall be tested at the end of such periods. Air-locks opened during periods when containment integrity is required by the unit's technical specifications shall be tested within 3 days after being opened. For air-lock doors opened more frequently than once every 3 days, the air-lock shall be tested at least once every 3

days during the period of frequent openings. For air-lock doors having testable seals, testing the seals fulfills the 3-day test requirement. Air-lock door seal testing shall not be substituted for the 6-month test of the entire air-lock at not less than P_d , the calculated peak containment pressure related to the design basis accident.

Type C Test

Type C tests shall be performed during each reactor shutdown for refueling but in no case at intervals greater than 2 years.

2.3 DOCUMENTATION

Allowable leakages are calculated in accordance with 10 *CFR* 100 and are incorporated into technical specifications. The results of ILRTs are documented in Reactor Containment Building Leakage-Rate Test reports submitted to the Commission. These reports also contain summaries of any Type B and C tests performed since the last Type A test. Excessive leakages are reported through licensee event reports (LERs).

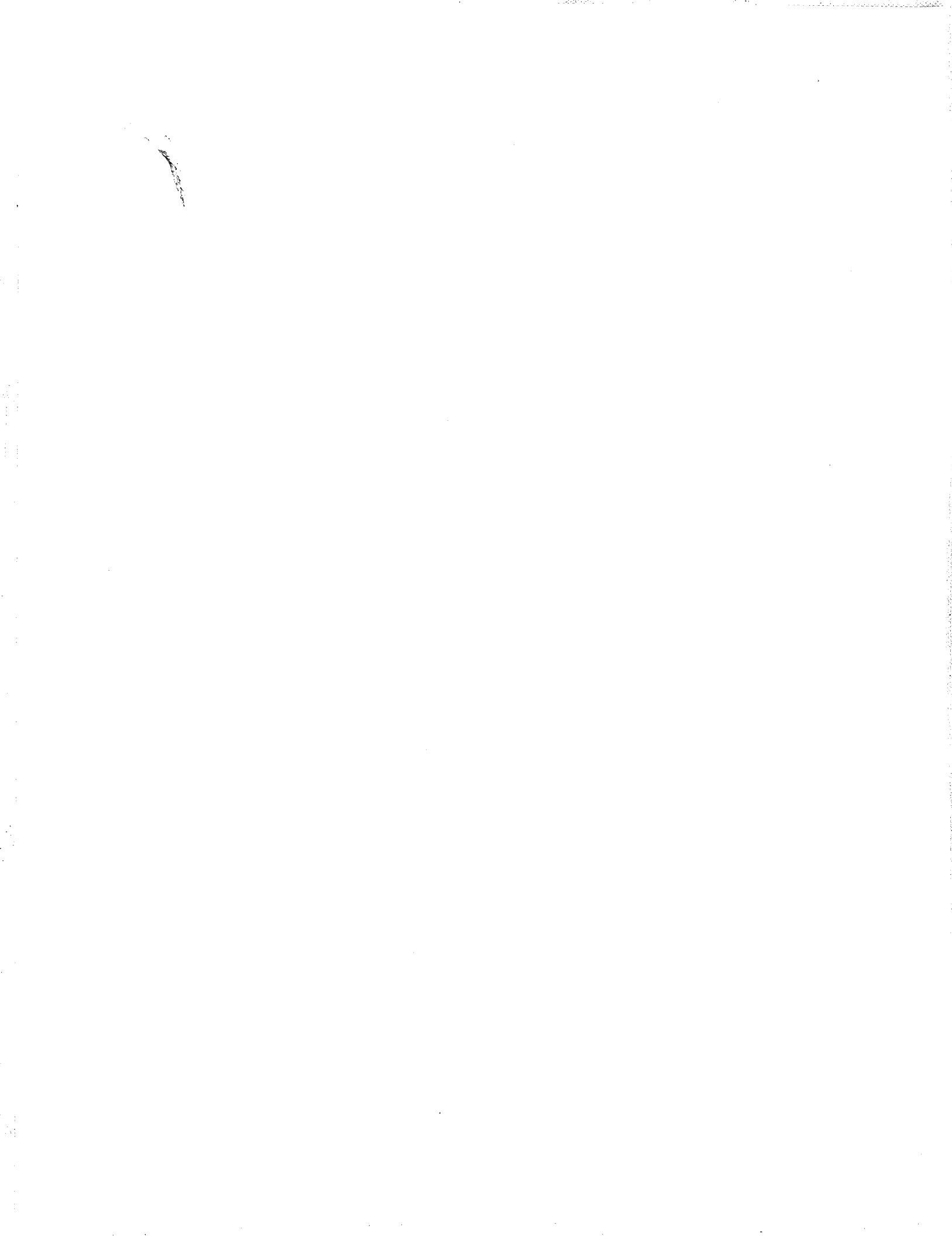

3. Containment Leakage-Rate Test Methods

Containment structure testing is intended to assure the leak-tight integrity of the containment structure under all design basis conditions. Containment leakage-test methods include integrated leakage-rate tests (ILRTs or Type A tests) and local leakage-rate tests (LLRTs or Type B and Type C tests). Recently, additional methods (referred to as on-line monitoring, or OLM) have been adopted by some countries in the international community to monitor containment integrity continuously during power operation. This chapter describes these test methods.

3.1 TYPICAL TEST METHODS

3.1.1 Type A Tests

What Tests Aim to Achieve

The sole purpose of the reactor containment system is to mitigate the consequences of potential accidents (e.g., loss-of-coolant accident [LOCA]) by minimizing the release of radionuclides to the environment and, thus, help assure the health and safety of the public. ILRTs are performed to verify the integrity of the containment system in its LOCA configuration such that the release of fission products to the environment under these postulated accident conditions does not exceed the limits established by the NRC in 10 *CFR* 100, "Reactor Site Criteria."

How Tests Are Conducted

Type A tests are performed by pressurizing the primary reactor containment to the calculated peak containment internal pressure (P_2) derived from the leakage design basis accident (LDBA) and specified in the unit technical specifications or associated bases. The primary reactor containment system is aligned, as closely as practical, to the configuration that would exist following an LDBA (e.g., systems are vented, drained, flooded, or in operation, as appropriate). At pressure P_2 , the actual containment leakage rate (L_2) is derived from measurements. The derived leakage rate,

referred to as the measured leakage rate (L_{am}), is expressed in percent per 24 hours by weight of the containment normal air inventory, with the leakage taking place at P_2 . The parameters actually measured are pressure, temperature, and humidity. Utilizing the Ideal Gas Law and placing a statistical boundary on the leakage rate calculated at a 95 percent probability or upper confidence limit, a true leakage rate is calculated.

The theory underlying the Type A tests is the determination of the containment air mass and the use of air mass versus time data during the duration of the test. Type A testing techniques can be divided into two categories, the reference vessel method and the absolute method.

- Reference Vessel Method

The reference vessel method uses a sealed vessel (usually a tube that runs throughout the containment) assumed to have the same average temperature as the containment. The density of the gas in the tube is constant regardless of pressure. The change in differential pressure between the tube and the containment is a direct measure of the change in contained atmospheric mass. The reference vessel method is no longer used due to difficulties in maintaining a leak-tight reference vessel.

- Absolute Method

In the absolute method, dry air mass is determined by accurately measuring the containment pressure at a single location, measuring the air temperature in 18-24 locations, and measuring the dew point in several locations. The average temperature of the atmosphere is determined by weight-averaging the volume of the various temperatures read. Using the Ideal Gas Law, the temperature and pressure readings are used to determine the total mass of the enclosed atmosphere. Dew-point readings are used to determine the amount of contained water vapor, which is subtracted from the total contained mass.

Test Methods

The leakage rate can be calculated from the measured mass versus time values via two methods. The first method is the total time method. This technique uses a set of leakage rates determined by the slope of the lines connecting the initial contained mass reading to each subsequent reading. The second method is the mass plot method in which the mass values determined are plotted versus time, with the slope of a linear least-squares-fit to the data being the mass leakage rate.

After the leakage rate has been measured, a verification test is conducted to confirm the reliability of the instrument readings. During this test, a known flow rate or step mass change is introduced into the containment, and the leakage rate or mass change measured by the instrumentation is determined and compared to the known value.

Specifics of the test and required instrumentation are provided in the American National Standard Institute (ANSI) standard N45.4-1972, "Leakage Rate Testing of Containment Structures for Nuclear Reactors," and ANSI/ANS standard 56.8-1987, "Containment System Leakage Testing Requirements."

Since very small leakage rates are being measured (as low as 0.1 percent per day maximum allowable leakage), accurate and sensitive instrumentation is required. In addition to instrument errors, errors in estimating average containment temperature may be caused by errors in weight-averaging the temperatures read.

Since Type A tests are on the critical path time before resuming power production, most of the constraints on Type A testing stem from the urgency to conduct the test quickly. Because the time available for the test is limited, optimum conditions are needed for testing.

Tests are conducted at postulated accident pressure and during unit shutdown with isolation valves positioned so that they may be tested. The actual leakage test usually does not last more than 24 hours, but other operations associated with the test (i.e., instrument set-up, pressurization, stabilization, verification, and depressurization) usually cause the test to span several days. During conduct of the test, access to the containment is not allowed, so little work can be done in parallel with a Type A test. As a result, the test is usually on the critical path during shutdown.

In the interest of reducing utilities' costs, efforts have been made to justify containment structure leakage tests of shorter duration and to analyze procedures for such tests to ensure sufficient accuracy of the measurements. Two documents supporting shorter duration tests are "Testing Criteria for Integrated Leakage Rate Testing of Primary Containment Structures for Nuclear Power Plants" from Bechtel (BN72), and "Criteria for Determining the Duration of Integrated Leakage Rate Tests of Reactor Containments" by the Electric Power Research Institute (EPRI83). The Bechtel report lays out guidelines and techniques for conducting Type A tests in as little as 6 hours. Statistical techniques are used to assign appropriate confidence limits to the measured leakage rate. The EPRI report contains an analysis and case study of 53 ILRTs and provides a technical basis for deciding when a test has produced accurate results such that the test may be terminated.

Since a Type A test relies upon the measurement of contained air mass and calculates the leakage from the change in mass over time, reduced duration tests would require much higher sensitivity in the instrumentation and weight-averaging schemes to yield data of acceptable accuracy. Increasing the acceptable leakage rate would reduce or eliminate the need for these higher sensitivities.

3.1.2 Type B Tests

What Tests Aim to Achieve

The Type B test verifies that the leakage rate of an individual containment penetration component is acceptable. Any Type B component that could affect containment system integrity must be Type B tested when it is modified or replaced to demonstrate that the component meets the applicable leakage-rate requirements. This allows testing individual components rather than retesting the entire containment system as in a Type A test.

How Tests Are Conducted

Type B tests are pneumatic tests conducted to detect and measure component leakage rates across pressure-retaining, leakage-limiting boundaries (other than valves and welds) on systems penetrating the containment vessel. This includes penetrations that incorporate resilient seals, gaskets, expansion bellows, etc., including the containment air-locks. These tests are typically conducted by pressurizing the test volume or inner space to P_a and measuring the rate of pressure loss utilizing air, nitrogen, or other suitable pneumatic fluid. The volumes tested are generally small, with the exception of the overall containment air-lock tests, and tests usually require less than 1 hour. Typically, a rotameter or mass flow meter is utilized to measure the actual leakage rate once test pressure is achieved.

3.1.3 Type C Tests

What Tests Aim to Achieve

The Type C test verifies that the leakage rate of the individual containment isolation valve (CIV) is acceptable. Any Type C component that could affect containment system integrity must be Type C tested when it is modified to demonstrate that the component meets the applicable leakage-rate standard. This allows

individual testing of a CIV rather than retesting the entire containment system (Type A test).

How Tests Are Conducted

Type C tests are pneumatic tests conducted to detect and measure component leakage rates across containment isolation valves. These tests are typically conducted by closing the CIVs, pressurizing the test volume to P_a , and measuring the rate of pressure loss utilizing air, nitrogen, or other suitable pneumatic fluid. The test volumes pressurized can vary from small to quite large depending upon line size and valve configuration. As a result, Type C LLRTs can last from 1 hour or less to 8 to 16 hours or more once test pressure is achieved. CIVs are tested at P_a such that the leakage through the valve is in the same direction that would occur subsequent to a design basis LOCA unless it can be demonstrated that testing in the reverse direction is conservative or equivalent. Typically, a rotameter or mass flow meter is utilized to measure the actual leakage rate once pressure is achieved.

3.1.4 Test Instruments

This section provides information on the accuracy and range of instrumentation used and/or available to measure containment leakage.

LLRT Test Instrument Accuracy

The two most common test methods used to conduct Types B and C LLRTs are (1) the pressure-decay method, and (2) the make-up flow-rate method. In either case, the test volume is pressurized to P_{ac} (or greater) and a temperature stabilization period of approximately 15 minutes is imposed prior to actual data acquisition. Typically, the test duration is also 15 minutes. However, this can vary due to volume considerations since more time would be required for a 36-inch purge valve versus a 3-inch instrument air valve.

Test Methods

Leakage-test instrumentation is typically calibrated on-site to the following specifications (FS = full scale):

Pressure-Decay Method

Temperature: Accuracy - $\pm 1^\circ\text{F}$
Resolution - $\pm 0.5^\circ\text{F}$
Repeatability - $\pm 0.5^\circ\text{F}$

Pressure: Accuracy - $\pm 1\%$ of P_{sc}
Resolution - $\pm 0.1\%$ FS
Repeatability - $\pm 0.1\%$ FS

Make-up Flow-Rate Method

Temperature: Accuracy - $\pm 2^\circ\text{F}$
Resolution - $\pm 1^\circ\text{F}$
Repeatability - $\pm 1^\circ\text{F}$

Pressure: Accuracy - $\pm 2\%$ of P_{sc}
Resolution - $\pm 1\%$ FS
Repeatability - $\pm 1\%$ FS

Flow: Accuracy - $\pm 2\%$ FS

NOTE: These are minimum values; higher accuracies are available.

Typically, utilities favor the make-up flow-rate method by a large majority, although certain tests may require the pressure-decay method (e.g., accumulator tests). The make-up flow-rate method is insensitive to specific volume or temperature corrections (if mass flow). Make-up flow is typically performed by utilizing mass-flow measuring devices or rotometers. Both are available to satisfy the test specifications. The mass-flow method requires an AC power supply or can be battery operated; rotometers do not require a power source. Both methods, like pressure decay, require an air or N_2 source. These instruments and the instruments used in the pressure-decay method are calibrated typically every six months.

In the examples stated above, the devices are readily available and affordable, can typically be calibrated at the site or returned to the vendor, and have been accepted by the industry for use in Type B/C testing.

Flow-Measuring Devices

Type B and C tests are generally performed utilizing one of two flow-test devices. This includes either the mechanical rotometer or the electronic mass-flow meter. Although either instrument is acceptable for this application, each has its own advantages and disadvantages, and each requires an external pressure source.

Mechanical Rotometer

Rotometers require no electrical power source or internal stabilization time and are generally less expensive than mass flow meters. Typically, three rotometers with overlapping ranges would be installed in a lightweight panel, along with associated regulators, valves, gauges and tubing. This panel could be hand carried throughout the plant or mounted on a portable hand dolly. It is not uncommon to have two panels, one for low- and one for high-range measurements.

One panel would cover 0-2000 scc/m (0-0.7 scf/m or 0-4.2 scf/h)(3 rotometers) and one would cover 2000-20,000 scc/m (0-7 scf/m or 0-42 scf/h)(3 rotometers)(28,317 sccm = 1.0 scf/m). The limiting factor would be size/weight considerations which are a function of the flow. Generally, the higher the flow to be measured, the larger the measuring device. Since measured flow rates rarely exceed 20,000 to 25,000 scc/m, this system is adequate for routine testing. Caution has to be utilized during actual test performance to prevent water contamination of the instruments. This would typically result from improper draining of a system to be tested and/or pressure within the system. These instruments have an accuracy of ± 1 percent with traceability certification. Calibration of these instruments can be

performed on-site depending upon the sophistication of the on-site calibration lab.

Mass-Flow Meter

Thermal mass-flow meters are portable, require an external power source (plug in) and internal stabilization time, and are more "delicate" to transport. A three scale unit is generally the size of a bread box. Thermal mass-flow meters have an accuracy of ± 1 percent with certification. Liquid contamination is a major concern since these devices generally require recalibration by the vendor (off-site shipping). The physical size of the devices (small) makes them ideal for measuring large flow rates. This becomes even more evident when considering that a 0-25 scf/m (0-1500 scf/h) mass-flow meter (single scale) is approximately the size of a coffee cup (excluding inlet and outlet straightening elements).

Generally, L_a equates to approximately 8 scf/m or less for the typical commercial LWR. Therefore, a 25 scf/m device above would be capable of measuring $> 3 \times L_a$. Aside from the outliers during the as-found LLRT, measured leakage rates are generally 5,000 sccm or less (0.18 scf/m or 10.6 scf/h), with the majority less than 1,000 sccm (0.035 scf/m or 2.1 scf/h) or less. By utilizing an instrument with this range, the existing non-quantitative reporting ("indeterminate", " $> 0.6 L_a$ ", "unquantified", etc.) can be reduced considerably, and quantitative data provided for evaluation at minimal cost. To measure the outliers (> 25 scf/m flow), other instrumentation can be added to the panel. However, the larger the flow to be measured, the greater the lengths of piping needed to act as stabilizers to achieve laminar flow.

3.2 ALTERNATIVE APPROACHES

Type A and most leakage tests on valves and penetrations can be conducted only during a unit shutdown. The integrity or leak-tightness of the

containment is not normally tested during reactor operation. A potential alternative or adjunct to Type A tests is on-line containment leakage monitoring.

A combination of Type A tests and an on-line monitoring capability is being actively pursued in Canada and in Europe, notably in France and Belgium, and is currently being considered in Sweden. This Section reviews different methods of on-line monitoring, and the modified Type A tests being conducted in these countries. The review is based on information provided by the European and Canadian nuclear regulatory authorities and industry, and meetings between the NRC staff and these organizations (NRC93C, NRC94A). OLM is used to identify a "normal" containment pressurization pattern and to detect deviations from that pattern. The underlying physical principles for on-line monitoring are summarized below. Details are provided in NUREG-1273 (NRC88).

- Ideal Gas Mass Determination

The use of ideal gas relationships to determine the contained air mass through measurement of air temperature, humidity, and pressure is the basis of current leakage testing. While there is no question as to the ability of the method to determine leakage rates accurately under relatively stable shutdown conditions, it is probable that the larger thermal gradients and air velocities in an operating containment affect the accuracy of the technique. More important, while Type A tests are conducted at full accident pressure, OLM is performed at very small pressure differentials; thus, the accuracy of OLM is expected to be lower.

- Tracer Gas Detection

This method uses the measurement of a natural or introduced gaseous tracer to detect containment leakage. One tracer gas method uses the detection of a tracer gas

Test Methods

outside of the containment which has a known concentration within containment. A tracer of interest for this method is ozone, since it is generated within containment and detection techniques are extremely sensitive. In the case of BWR Mark I and Mark II containments and possibly dual-wall PWR containments, the leakage through all possible leakage paths is drawn through a single duct, making tracer detection relatively straightforward.

Another tracer method technique uses a concentration monitor within containment to record dilution of the tracer caused by inleakage. This method is applicable only to containments normally operating at negative gauge pressure.

- **Bulk Temperature Measurements**

Bulk temperature measuring techniques are related to the ideal gas mass determination method but use global methods of determining a properly weight-averaged temperature of the atmosphere. Acoustic velocity and refractive index measurement techniques can also be used. Both these techniques require a relatively uncluttered, open containment geometry.

- **Mass Change Input/Exhaust Monitoring**

This method introduces or removes a quantity of air in a continuous or discrete manner. Primary considerations are the existence of equipment on site capable of producing the desired mass change, the capability of measuring small pressure changes produced by the mass change, and the allowable limits for containment pressure during operation.

- **Reference Vessel Method**

This method uses a device similar to the reference vessel for Type A tests. Support of these techniques requires information

concerning pressures, temperatures, and temperature gradients existing in operating containments.

- **Direct Air Weighing**

This method uses the vertical differential atmospheric pressure in containment to determine directly the enclosed air mass. The method is extremely sensitive to local stagnation pressures and somewhat dependent on containment internal geometry and variations in temperature profile.

NUREG-1273 (NRC88) discusses 11 methods utilizing the physical principles stated above. The characteristics of the 11 on-line monitoring methods are summarized in Table 3-1. Three methods (Type A test instrumentation, reference vessel, and differential trace gas concentration) are generally applicable to all reactor units. The estimates of equipment cost shown in the table are based only on the required equipment.

Capabilities of On-Line Monitoring Systems

The following technical findings are taken from NUREG-1273:

- Methods exist which appear practical and sufficiently sensitive to be of use for continuous leakage monitoring.
- OLM does not have the accuracy of Type A testing but seems to offer enough accuracy and speed of detection to justify its use for detecting gross leakage.
- OLM is capable of detecting leaks within 1 day to several weeks, versus an average of 6-12 months for Type A, B and C tests.
- The current program of Type A, B, and C tests is capable of detecting all reported events documented in the Licensee Event Reports (LERs). Supplemental use of OLM will not detect additional breaches of containment integrity.

Table 3-1. Characteristics of On-line Monitoring Methods

On-Line Monitoring Methods	Containment Type	Sensitivities			Equipment Costs
		Humidity	Temp	Inleakage	
External detection	BWRs	No	No	No	L
Tracer gas dilution	Subatm	No	No	Yes	L
Continuous injection	PWRs	Yes	Yes	Yes	H
Direct weighing	Large, dry subatm	Yes	No	Yes	M
Acoustic velocity	Large, dry subatm	Yes	No	Yes	H
Reference vessel	All	Yes	No	Yes	H
Type A test instrument	All	No	No	Yes	H
Trace gas mass concentration	Subatm	No	No	Yes	M
Differential trace gas concentration	All	No	No	No	M
Periodic air mass injection	PWRs	Yes	Yes	Yes	H
Nitrogen usage monitoring	BWRs	Yes	Yes	Yes	L

Note: L - low, M - moderate, H - high, Subatm - subatmospheric

- Type B and C tests together are capable of detecting 99.4 percent of documented breaches; only the remaining 0.6 percent of breaches requires some tests other than Type B and C.
- For the remaining 0.6 percent of breaches, OLM is estimated to be capable of detecting five out of six breaches. In other words, OLM would improve detection of documented breaches by 0.5 percent.
- OLM cannot detect leaks in a double barrier. Thus, the estimated unavailability of containment isolation for the small ($1 L_a - 10 L_a$) and large ($> 10 L_a$) leakage categories would not be improved significantly if an OLM were adopted, since leakages of these sizes generally occur in paths with double barriers. For the very large leakage category (e.g., open air-locks or the failure of other containment openings, open purge/vent pathways, or similar direct air path system valves or penetrations), the unavailability might be improved by as much as an order of magnitude.
- OLM should not be considered as a complete replacement for Type A tests because OLM operates at reduced pressure. Prediction of leakage and structural integrity at accident pressure based on low pressure tests is not accurate because there is no correlation between the two.

Test Methods

- Current Type B and C tests identify nearly all potential leakages. Prudence dictates maintaining the current refueling-cycle time period for conducting Type B and C tests.
- Type A, B, and C tests required by Appendix J should be continued to provide assurance of continued high containment availability. OLM might improve containment unavailability due to very large leakages by less than an order of magnitude.
- There is no risk justification for imposing OLM. Estimated contribution of undetected leakages to the total risk associated with other containment failure modes in a severe accident is less than 0.5 - 3 percent.
- An estimate of installation and operational OLM costs is on the order of \$0.5 million - \$1.0 million.

3.2.1 The Belgian Approach

On-line Monitoring

During reactor operation, the pressure in the containment tends to increase due to compressed air leaks from pneumatically operated equipment. By monitoring the compressed air make-up to the containment, it is possible to calculate the containment leakage rate from the discrepancies between the theoretical increase in containment pressure and the measured pressure increase. The calculation takes into account the temperature and moisture variations during the tests.

The test is conducted during reactor operation after each cold shutdown longer than 15 days. It is performed after the startup of the unit when steady state conditions (e.g., temperature, moisture) have been reached inside the containment atmosphere. If, after two months of maintaining the primary system temperature

above 260 °C, it has not been shown that the leakage rate of the containment is below 17Nm³/h, the unit shall be brought to cold shutdown. Such a test can be completed in less than 72 hours.

After the completion of the leakage test, a nonmandatory verification test may be performed by superimposition of a leak through a calibrated orifice. For these tests, either the absolute or reference vessel is acceptable.

The objective of the test is to detect gross localized leakages such as misaligned valves or left-open valves and faulty flanges or instrument connections.

The test acceptance criteria are as follows:

<u>Leakages at 60 mbar (0.88 psig) differential pressure</u>	<u>Action</u>
Not greater than 5 Nm ³ /h (177 scf/h)	None (considered normal condition)
Greater than 5 Nm ³ /h (177 scf/h) but less than 17 Nm ³ /h (600 scf/h)	Search for leakage locations
Greater than 17 Nm ³ /h (600 scf/h)	Cold shutdown if leakages cannot be located and isolated within a month

For Belgian PWRs, a leakage rate of 17 Nm³/h (600 scf/h) at 60 mbars (0.88 psig) and containment temperature corresponds to about ten times L_a at accident pressure, P_a. Physically, 17 Nm³/h (600 scf/h) also corresponds to the flow rate through a hole of 1 cm (about 3/8 inch) diameter in a thin plate at an effective pressure of 60 mbars (0.88 psig).

Modified Type A Testing

The objective of the Belgian approach to Type A testing is to reduce the frequency and duration of the tests. The Type A test is conducted at a containment pressure (P_i) not less than half of the peak pressure ($0.5 P_a$). It is performed once every 10 years. The test acceptance criterion is:

$$L_{m_i} \leq 0.75 (P_i/P_a) L_a$$

where L_{m_i} is the measured leakage at P_i and L_a is the maximum allowable leakage rate at P_a . The rationale for testing at P_i instead of P_a and the use of a new test acceptance criterion are discussed in Appendix C.

Type A tests are performed using both the absolute method and the reference vessel method. These two methods are totally independent, and their results can be used for mutual validation. If, over a period of at least 8 hours and with at least 30 consecutive measurement points, both of the methods provide a leakage rate meeting the above acceptance criterion, the test can be discontinued. A verification test (i.e., calibrated leakage test) may or may not be required at the end of the test period depending upon the difference between the measured leakage rates derived from the two methods. Further discussion is provided in Appendix C.

3.2.2 The French Approach

On-line Monitoring

Containment leak-tightness is being continuously monitored during reactor operation in all of the French PWR units using the SEXTEN OLM system. The French safety authorities and EDF decided to equip their PWRs with OLMs "Even if the potential risk associated with such risks is low...." SEXTEN is also being evaluated by the Swedes for their PWR units.

On-line leakage detection is based on the fact that the pressure inside the containment is successively below and above atmospheric pressure. The containment pressure goes up due to leakage of the air from the instrument compressed air distribution system. When the pressure reaches a set limit, the operator quickly depressurizes the containment and a new pressurization cycle begins. A typical cycle is about 20 days for a 900 MW PWR unit.

Leakages may be detected during the positive or negative pressure periods in the containment by evaluating the air mass balance in the containment. The air mass is measured by the absolute method.

The test acceptance criteria adopted by the French (SEPRI94) are:

For 900 MWe PWRs:

<u>Leakages at 60 mbar (0.88 psig) differential pressure</u>	<u>Action</u>
Not greater than 5 Nm ³ /h (177 scf/h)	None (considered normal condition)
Greater than 5 Nm ³ /h (177 scf/h) but less than 10 Nm ³ /h (354 scf/h)	Search for leakage locations
Greater than 10 Nm ³ /h (354 scf/h)	Cold shutdown if leakages cannot be located and isolated within 10 days Cold shutdown in 20 days if leakages can be isolated by containment isolation

Test Methods

For 1300 MWe PWRs:

<u>Leakages at 60 mbar (0.88 psig) differential pressure</u>	<u>Action</u>
Not greater than 5 Nm ³ /h (177 scf/h)	None (considered normal condition)
Greater than 8 Nm ³ /h (283 scf/h) but less than 16 Nm ³ /h (566 scf/h)	Search for leakage location and begin procedure for cold shutdown within 14 days
Greater than 16 Nm ³ /h (566 scf/h)	Cold shutdown if leakages cannot be located and isolated within 3 days Cold shutdown in 14 days if leakages can be isolated by containment isolation

For a 900-MW unit containment (free volume of about 50,000 m³ or 1,766,000 ft³), the average uncertainties with the SEXTEN system for a containment leakage rate at 60 mbars (0.88 psig) effective pressure differential are:

- 1.3 Nm³/h (46 scf/h) over a 24-hour measurement period; and
- 0.8 Nm³/h (28 scf/h) over a pressurization cycle in the containment.

It takes approximately 4 hours of measurements to confirm the development or elimination of a 5 Nm³/h (177 scf/h) leakage. This corresponds to a leakage rate of about 0.25 volume percent per day. The French believe SEXTEN is able to detect a leak corresponding to a less than 3 mm (7/64") diameter pipe in a 24-hour test period.

The method can be used not only to detect a leakage problem, but also as an aid in identifying the leakage paths or the defective components. The system operates continuously and provides measurements daily or at the end of each pressurization cycle. At the operator's command, the evolution of the air mass inside the containment can be plotted in real time when leakage paths are sought. Appendix C describes the SEXTEN system in more detail.

The Swedes are currently evaluating the SEXTEN system. They are considering the following test acceptance criteria:

<u>Leakages at 60 mbar (0.88 psig) differential pressure</u>	<u>Action</u>
Not greater than 5 Nm ³ /h (177 scf/h)	None (considered normal condition)
Greater than 5 Nm ³ /h (177 scf/h) but less than 15 Nm ³ /h (530 scf/h)	Identify the leakages and take corrective actions within a limited time
Greater than 15 Nm ³ /h (530 scf/h)	Inform SKI (Swedish Nuclear Inspectorate) and provide an action plan

Type A Testing

Type A tests are conducted at containment peak pressure (loss-of-coolant accident [LOCA] pressure) before initial unit startup, during the first refueling, and thereafter every 10 years unless a degradation in containment leak-tightness is detected. If the margin between the allowable limit and the measured value decreases by more than 75% between two consecutive ten-yearly tests and if the cause of this leakage cannot be identified and corrected, the next Type A test must be performed within five years (SEPRI94).

3.2.3 The Canadian Approach

As summarized below, Canada's Hydro-Quebec uses the Temperature Compensation Method (TCM) for on-line, low-pressure testing for containment integrity at the Gentilly-2 Nuclear Power Station. The TCM uses a reference volume with an extensive tubular network of different diameters, and a second independent tubular network with numerous humidity sampling points (CAN94).

The reference volume is composed of a leak-tight network of copper tubing throughout the significant volumes of the reactor building. The tubing is sized and routed in such a way that the reference volume fraction contained within each room is proportional to the volume of the room. This arrangement enables the determination of the "equivalent" or "weighted" reactor building temperature and eliminates the need to track numerous temperature points. The reference volume simulates the overall reactor building behavior and allows the leakage-rate determination to be independent of reactor building temperature fluctuation. The differential pressure between the tubular network reference volume and the reactor building constitutes the critical process variable.

A major difficulty of a low-pressure test is the measurement of an extremely small pressure drop. During an 8-hour test at 2.75 kPa(g), a typical pressure drop could be 0.043 kPa(g), where Pa(g) is relative pressure measured in units of Pascal. This is compared to a pressure drop of 0.376 kPa(g) during an 8-hour test at containment peak pressure of 124 kPa(g). These figures presume a 0.5% of reactor building volume per day leakage rate and 100% turbulent flow. The meaningful interpretation on the minute pressure drop imposes a stringent precision requirement on the TCM system.

The reactor building humidity plays a major role in on-line, low-pressure testing. Under typical conditions, the dew point in the reactor building

may increase from 4.5 °C (40 °F) to 5.0 °C (41 °F) during the test. The increase in vapor partial pressure is a factor of three over the test pressure drop. Hence, a precise determination of average reactor building humidity and its variation in time and space is critical.

The tubular network of numerous humidity sampling points installed inside the reactor building enables the measurement of minute pressure variations inside the reactor building, independent of the spatial and temporal humidity behaviors. The humidity and temperature mapping exercise conducted during an annual shutdown has confirmed the ability of the humidity sampling tubular network layout to adequately track reactor building humidity. An error of 3.2% on the pressure drop was indicated from a detailed error analysis.

It is not possible to fully isolate several process gas systems inside the reactor building at power. Gas leakage from the various reactor auxiliary systems during normal operation contributes to the existing water vapor partial pressure. These gases include helium, carbon dioxide, and nitrogen. The contribution from these leakages has been shown to be minor (less than 2% of the leakage rate).

The atmospheric pressure may vary dramatically during the test period. An increase in the atmospheric pressure during a test is reflected by a decrease in the test differential pressure. It is possible that the positive differential pressure of the reactor building with respect to the atmosphere may be reduced by as much as 50% during the test as a result of a weather perturbation.

A post-test validation procedure is required to verify the TCM test result. A "known" leakage rate, of magnitude comparable to the "unknown" leakage rate, is superimposed upon the latter directly upon conclusion of the "unknown" leakage-rate measurement.

Test Methods

The TCM system can be used at any test pressure. However, the Gentilly-2 TCM system is limited to a maximum test pressure of 3.4 kPa, which correspond to the reactor trip set point of the safety shutdown systems on high reactor building pressure. The test at a nominal 3 kPa(g) test pressure can be completed during a 12-hour period (28 hours total with alignment time) with the reactor at full power. This is compared to the required 5-day critical path window (7 days total with alignment time) during an annual shutdown for the traditional reactor building pressure test (Type A test) performed at 124 kPa(g).

The Gentilly-2 TCM system is able to detect a leak corresponding to a 2 mm (5/64") diameter pipe, with high precision in an 8-hour test period. The error associated with the measurement at a nominal test pressure of 3 kPa(g) was $\pm 10\%$ based on theoretical analysis under typical test conditions. The available data from the "known leakage-rate" test validation procedure suggests that the actual error band is less than 15%.

With on-line, low-pressure testing, Hydro-Quebec is able to detect and monitor the change in containment leak-tightness between Type A tests. Available test results indicate that it is possible to extrapolate the on-line, low-pressure leakage rate to the equivalent Type A test leakage rate at high pressure. Confirmation of this capability, however, will require a larger data base of low-pressure test and Type A test results.

Hydro-Quebec has indicated that their system is new and evolving, and that they are currently pursuing various applications of the system.

Further discussion of the Gentilly-2 TCM system is provided in Appendix C.

3.2.4 Discussion

The primary limitation of OLM is that it is conducted while a unit is operating when control over many parameters is not practical. The containment atmosphere tends to be much more erratic during operation because of operating fan coolers and large and fluctuating heat sources.

The large amounts of heat released into containment produce large thermal gradients and contribute to less stable conditions. Thermal gradients complicate calculation of an average containment temperature which is done by weight-averaging the temperature with volume.

Other conditions in operating containments that could obscure results from on-line leakage-rate monitoring systems are the usage of instrument air, continuous sample lines, containment access, vent and purge operations, and gas releases into containment from coolant systems.

Despite the potential operating challenges, the Canadian and the European communities have had successful experiences. OLM systems have been installed in all of the French reactors since 1985 and have accumulated 250 reactor-years of experience. The capability of measuring 1 Nm³/h (35 scf/h) leakage, as claimed by the French and Belgium on-line monitoring systems, and the capability of measuring leakage through a 2mm (5/64") hole, as claimed by the Canadian OLM, exceed the expectation of past studies (i.e., NUREG-1273).

OLM systems can only detect those leaks located in systems that provide a connection between the containment air and the outside atmosphere. Based on data collected at North Anna Power Station, listed below are penetrations exposed to the containment atmosphere.

<u>Type of Penetrations</u>	<u>Size of Penetrations</u>	<u>Number of Penetrations Exposed to Containment Atmosphere</u>
Mechanical (total 92 penetrations)	3/8"	3
	2"	2
	4"	1
	6"	1
	8"	1
	36"	<u>2</u>
		10 (~ 11%)
Electrical (total 129 penetrations)		129 (100%)

In summary, on-line monitoring systems can be useful in detecting and locating certain containment leaks during reactor operation.

However, the usefulness of an on-line monitoring system depends upon the utility's ability to:

- account for the effects of temperature and moisture gradients and variations on the test results;
- preclude the possibility of an actual leak being masked by containment air/gas inleakage;
- account for leaks in closed pressurized systems that would probably not be measured during on-line monitoring;
- guard against "false alarms" from on-line monitoring; and,
- achieve stabilized conditions within the containment during reactor operation.

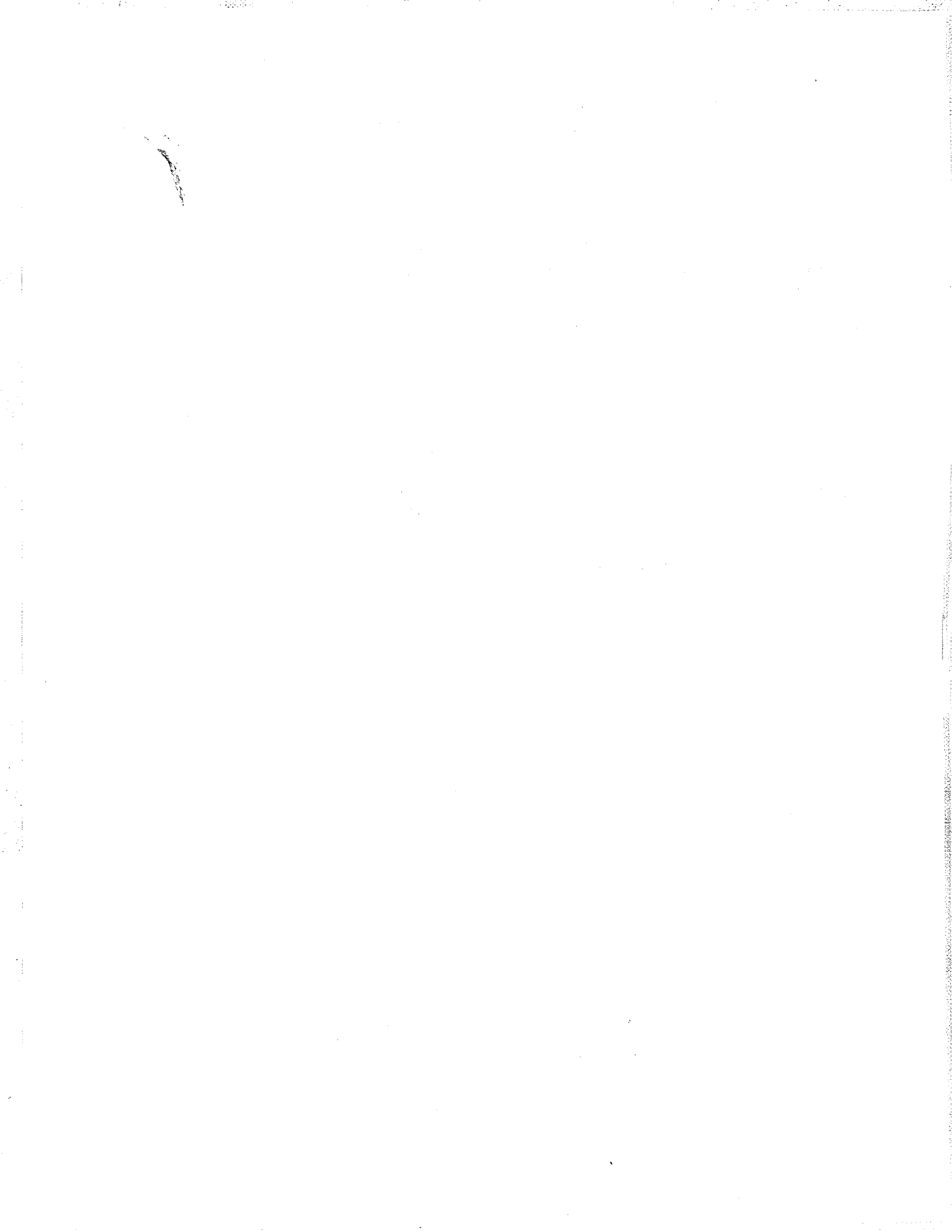

4. Leakage-Rate Test Experience

Because of concerns about undetected loss of containment isolation capability, an early NRC study (NUREG/CR-4220)(NRC85) undertook the compilation of an historical data base related to possible violations of containment isolation. The data in this compilation were derived primarily from Licensee Event Reports (LERs) submitted to the NRC between 1965 and 1983. Although this compilation included more than 3400 suspected containment isolation failures, it did very little evaluation of the nature and potential significance of the reported technical specification violations and, thus, was not very useful for the purposes of the present effort.

A subsequent study (NUREG-1273)(NRC88) undertook a more extensive evaluation of the same data base. Some of the findings of the latter study included:

- About one-third of the reported events dealt with leakages that were immediately detected and corrected, thus posing minimal threat to containment integrity.
- Events related to components located in direct containment-to-atmosphere paths were a small fraction (about 1/6) of the total.
- The great majority of reportable events were detected by Type B and Type C leakage testing; only 25 of 2192 events were detectable only by Type A integrated containment leakage testing.

In addition to these studies, the present study analyzed a data base compiled by the NRC, the results of Appendix J testing at the two-unit North Anna station, and an Appendix J exemption request submitted by the Grand Gulf station. In February 1994, the NRC received for analysis a letter (NUM94) from the Nuclear Management and Resources Council (NUMARC) transmitting containment testing data representative of a broad spectrum of units.

4.1 TYPE A ILRT

To verify the validity of the suggestions that local leakage-rate testing can detect essentially all potential degradations of containment integrity, more recent experience with containment leakage rates has been evaluated. For this purpose, a data base compiled by NRC staff was used as a point of departure (NRC93A)¹. This data base is a compilation of LERs, FSAR revisions, ILRT reports, exemption requests, technical specification changes, etc., from June 1987 through April 1993. Of specific interest are the 166 ILRT reports included in this compilation covering 97 individual units at 68 sites. Of the ILRT reports in the data base, 42 have been identified in the data base as failed. Details of the failures or how they were detected are not always included in this compilation. Nevertheless, it is noted that, of the identified failures, approximately 25 percent exhibited "as-found" leakage rates greater than $0.75 L_a$, but less than $1.0 L_a$. Another 20 percent of the identified failures were characterized by "as-found" leakages less than $5 L_a$. For the remaining 55 percent of the identified failures, the leakage rates were not quantified, typically because the leakages exceeded the range of the measurement instrumentation. For local leakage-rate testing, the range of the instrumentation used is comparable to the allowable leakage rates; thus, even marginal violations of allowable leakage rates cannot be quantified.

In order to assess the causes of the reported ILRT failures, the test reports identified as failures have been reviewed in detail. Table 4-1 summarizes a number of reported ILRT failures. In most of the reported ILRT failures, the integrated leakage-rate test itself met the $0.75 L_a$ criterion; the reported "as-found" leakages were detected by Type B and C testing and corrected prior to the ILRT. This is typical of current ILRT practice, i.e., Type B and C testing is performed prior to the ILRT and the as-found

¹ U.S. Nuclear Regulatory Commission, "The 'Gunter Arndt' Appendix J Data Base," kept current.

Table 4-1. Examples of Failed ILRTs

Unit	Description
ANO-1	5/92 ILRT; .75 L_a = .150% per day; As-Found > L_a ; As-Left = .125% per day. Leakage found by LLRT.
Beaver V 1	12/89 ILRT; .75 L_a = .075% per day; As-Found = excessive; As-Left = .031672% per day. Two penetration leaks discovered during ILRT.
Braidwood 1	2/91 ILRT; .75 L_a = .075% per day; As-Found = .0557% per day; As-Left = .05286% per day. TYPE B failure found during ILRT, after earlier successful TYPE B test. ILRT performed with outer air-lock door open; leak in hatch shaft seal.
Braidwood 2	9/91 ILRT; .075 L_a = .075% per day; As-Found = .0554% per day; As-Left = .05359% per day. Several local leaks found during ILRT, after having passed Type B; ILRT done with outer doors open.
Brunswick 1	2/91 ILRT; .75 L_a = .375% per day; As-Found = .4956% per day; As-Left = .3408% per day. Leakage found by LLRT.
Brunswick 2	2/90 ILRT; .75 L_a = .375% per day; As-Found = .47% per day; As-Left (MP) = .317% per day; As-Left (TT) = .344% per day. Leakage found by LLRT.
Brunswick 2	12/91 ILRT; .75 L_a = .375% per day; As-Found = .3975% per day; As-Left = .3545% per day. Leakage found by LLRT.
Callaway 1	10/90 ILRT; .75 L_a = .150% per day; As-Found > .150% per day; As-Left = .0446% per day. Penetration leakage.
Cooper	12/10/91 ILRT; As-Found = 1.38 L_a . Leakages found by LLRT.
Dresden 2	12/90 ILRT; .75 L_a = 1.2% per day; As-Found = 24.5% per day; As-Left = 0.7428% per day. Vacuum breaker valve leakage found by ILRT.
Dresden 3	2/90 ILRT; .75 L_a = 1.2% per day; As-Found = 1.25% per day; As-Left = 1.0075% per day. Leakage found by LLRT.
Dresden 3	3/92 ILRT; .75 L_a = 1.2% per day; As-Found > L_a ; As-Left = .6706% per day. Leakage found by LLRT.
Fermi 2	11/89 ILRT; .75 L_a = .375% per day; As-Found = .958% per day; As-Left = .318% per day. Leakage found by LLRT.
Fermi 2	10/92 ILRT; .75 L_a = .375% per day; As-Found < 2 L_a ; As-Left = .2434% per day. Leakage found by LLRT.
Harris 1	10/89 ILRT; ILRT without prior LLRT. As-Found not quantified.
Hatch 2	11/89 ILRT; 75% L_a = .90% per day; As-Found = 1.03% per day; As-Left = .80% per day. Leakage found by LLRT.
Hatch 2	11/92 ILRT; .75 L_a = .9% per day; As-Found = 1.3357% per day; As-Left = .8858% per day. Leakage found by LLRT.

Table 4-1 (Continued)

Unit	Description
LaSalle 2	6/90 ILRT; .75 L_a = .476% per day; As-Found > .476% per day; As-Left = .427% per day.
LaSalle 2	3/92 ILRT; .75 L_a = .476% per day; As-Found = .3523% per day; As-Left = .6155% per day. Leakage found by LLRT.
Millstone 1	6/91 ILRT; .75 L_a = .90% per day; As-Found > .90% per day; As-Left = .4077% per day. Leakage found by LLRT.
Palo Verde 2	12/91 ILRT; .75 L_a = .075% per day; As-Found = .083% per day; As-Left = .031% per day. Leakage found by LLRT.
Pilgrim 1	7/91 ILRT; .75 L_a = .75% per day; As-Found = 1.2% per day; As-Left = ?. Failed ILRT, drywell head bolts loose.
Quad Cities 2	11/86 ILRT; .75 L_a = .75% per day; As-Found = .882% per day. Failed ILRT, faulty drywell head gasket.
Quad Cities 1	9/14/87 ILRT; ILRT prior to LLRT, failed. Cause unknown.
River Bend	8/92 LLRT; .75 L_a = .195% per day; As-Found = Failed; As-Left = .141% per day. Type B & C exceeded .6 L_a .
Sequoyah 1	5/90 ILRT; .75 L_a = .1875% per day; As-Found = .7% per day; As-Left = .148% per day. Leakage found by LLRT.
Sequoyah 2	5/90 ILRT; .75 L_a < As-Found < 1.0 L_a . ILRT found penetration leakage missed by faulty LLRT.
Sequoyah 2	4/92 ILRT; .75 L_a = .1875% per day; As-Found = .42122% per day; As-Left = .15154% per day. Leakage found by LLRT.
Susquehanna 2	6/86 ILRT; L_a = .75% per day; As-Found = 2.6% per day; As-Left = .59% per day. ILRT prior to LLRT.
TMI-1	11/86 ILRT; .75 L_a = .075% per day; As-Found ~ .1% per day. ILRT prior to LLRT.
Trojan	5/29-6/2/90 ILRTs; .75 L_a = .1% per day; As-Found = ?%; As-Left = .00616% per day. Instrumentation problems during LLRT.
Vogtle 2	4/92 ILRT; .75 L_a = .150% per day; As-Found = .1507% per day; As-Left = .1410% per day. Leakage found by LLRT.
Vt Yankee	.75 L_a = .6% per day; As-Found = .8% per day. Drywell manway penetration leakage.

Test Experience

leakage rate is determined by adding the leakage savings resulting from the repair of local leakages to the measured ILRT leakage. In a number of the other reported failures, local leakages were actually detected by the ILRT. In almost all these cases, the ILRTs were performed without a preceding Type B and C test. In one case, a faulty LLRT failed to identify a local leakage which was found by the subsequent ILRT. Local leakage-rate testing did not and could not detect excessive leakage in three of the cases identified as failures in the above data base. One of the ILRT failures was associated with Mark I BWR head closure leakage and one with a steam generator manway; the root cause of the third was not resolved.

In addition to the NRC data base, LERs related to containment leakage-rate testing compiled by Oak Ridge National Laboratory (ORNL) have also been examined. Most of the possible ILRT failures identified by this search were duplicates of the reports included in the NRC data base. Only one additional ILRT failure was found in the Oak Ridge compilation. In this case, the excessive leakage was due to a faulty gasket on a Mark I BWR head. The "as-found" measured leakage was $0.84 L_a$.

In the approximately 180 ILRT reports considered in this study, covering 110 individual reactors and approximately 770 years of operating history, only 5 ILRT failures were found which local leakage-rate testing could not and did not detect. These results indicate that Type A testing detected failures to meet current leak-tightness requirements in approximately 3 percent of all tests. These findings clearly support earlier indications that Type B and C testing can detect a very large percentage of containment leakages. The percentage of containment leakages that can be detected only by integrated containment leakage testing is very small. Of note in the ILRT failures observed that were not detected by Type B and C testing, the actual leakage rates were very small, only marginally in excess of the current leak-tightness requirements.

NUMARC

The Nuclear Management and Resources Council (NUMARC) conducted a survey of utilities to study containment testing performance and cost data (NUM94). The utilities chosen represent a broad spectrum of reactor designs (29 units in all) and encompass a total of 144 ILRTs. Performance data studied include test results of ILRTs since pre-operation tests, and cause(s) of failure by valves type, size, and service.

NUMARC has provided a summary of their analysis of 144 ILRT results. Type A performance test data is shown in Table 4-2. Of the total, 23 of the ILRT results exceeded $1.0 L_a$. The reasons for exceeding allowable leakage are stated as follows:

- 14 due to addition of Type B & C leakage penalties
- 4 due to PWR steam generator in-leakage
- 2 due to failures that should have been indicated by the Type B & C testing
- 2 due to ILRT line up errors
- 1 test repeated due to unacceptable verification test.

Examination of the quantitative leakage data provided in the NUMARC summary indicates that in about one-third of the cases exceeding allowable leakage, the as-found leakage was less than $2L_a$; in one case the as-found leakage was less than $3L_a$; one case approached $10L_a$; and in one case the leakage was found to be approximately $21L_a$. For about half of the failed ILRTs the as-found leakages were not quantified.

Overall the results of the NUMARC analysis of ILRT experience are consistent with the results found in the NRC data base (NRC93A).

4.2 TYPE B LLRT

Type B tests are performed at power or shutdown on two types of equipment: electrical

Table 4-2. Type A Performance Test Data

Line Item No.	Unit No.	ILRT Mo/Yr	75 L _a sccm	As-Found Leakage Rate sccm	As-Found Leakage Rate W/B&C Delta, sccm	Code
1	1	Apr-92	270,000	224,640	>270,000	D
2	2	Apr-91	122,250	76,121	136,431	A2
3	3	Nov-85	158,700	76,098	399,223	C
4	3	Nov-93	158,700	42,732	283,320	LUE
5	4	Mar-78	259,000	304,480	UNAVAIL	A3
6	4	Jun-82	259,000	148,780	264,690	LUE
7	19	Aug-83	62,400	107,355	-	C
8	20	Oct-90	141,709	321,314	321,314	A2
9	21	Feb-81	141,709	120,023	N/A	E
10	21	Sep-92	331,894	564,662	N/A	A3
11	23	May-86	101,940	37,926	134,042	D
12	24	Apr-77	131,000	175,000+	175,000+	A3
13	24	Nov-86	131,000	175,000	175,000	A3
14	25	Jun-80	398,500	38,736	uncertain	C
15	25	Apr-84	398,500	16,678	uncertain	C
16	26	Jun-85	646,730	166,139	17,954,023	D
17	27	Aug-87	177,152	64,415	581,441	C
18	27	Jun-91	177,152	68,343	-	C
19	28	Aug-84	71,498	67,588	1,421,687	C
20	28	Apr-86	71,498	<4,699	<910,914	C
21	28	Sep-87	215,556	123,591	-	D
22	30	Sep-88	163,878	infinite	infinite	C
23	31	Sep-90	163,878	infinite	infinite	C

<u>CODE</u>	<u>DESCRIPTION</u>	<u>FREQUENCY</u>
A1	Containment Liner Breach	0
A2	B&C Leakage Identified by ILRT, Not B&C LLRT	2
A3	PWR Steam Generator Secondary Manway Gasket Leakage	4
B	ILRT L _a Exceedance Due To B Leakage Penalty Identified By LLRT	0
C	ILRT L _a Exceedance Due To C Leakage Penalty Identified By LLRT	10
D	ILRT L _a Exceedance Due To B&C Leakage Penalty Identified By LLRT	4
E	ILRT L _a Exceedance Due To Instrument Verification By Test Discrepancy	1
LUE	ILRT L _a Exceedance Due To Line-Up Error	2

Test Experience

penetrations and air-locks (and other double-gasketed and double O-ring seals).

North Anna

Appendix A, "Analysis of Type B/C Leakage-Rate History," discusses the results of Type B testing of penetrations at North Anna Units 1 and 2.

Each North Anna unit contains approximately 130 electrical penetrations. Based on the data discussed in the appendix, North Anna has experienced no significant electrical penetration leakage in approximately 27 unit-years of operation.

Based on the above information, performance-based Type B testing would result in a significant reduction in tests of the electrical penetrations. If the leakage pattern of these penetrations do not deviate from the historical leakage pattern, an insignificant increase in risk would result from performance-based testing of these penetrations.

Type B testing is performed on all air-locks, i.e., the fuel transfer tube, the personnel air-lock, the emergency escape air-lock, and the equipment hatch at North Anna. The fuel transfer tube is tested approximately every 18 months. The personnel air lock, emergency escape air-lock, and equipment hatch are tested at 6-month intervals.

No "as-found" leakage rate is determined for the equipment hatch during Type B tests unless the test coincides with an ILRT. Since June 1987, a seal has been replaced on the Unit 1 equipment hatch five times. Since April 1989, a seal has been replaced on the Unit 2 equipment hatch two times.

The door seals for the fuel transfer tubes in Unit 1 and Unit 2 were replaced in December 1985 and August 1984, respectively. There has been zero leakage through these seals since that time.

Since January 1986, either a personnel air-lock seal has been replaced or a door adjusted 13 times for Unit 1. Since August 1986, either a personnel air-lock seal has been replaced or a door adjusted 12 times for Unit 2. Maximum path leakage rates for both Unit 1 and Unit 2 personnel air-locks have ranged from zero to 22 scf/h.

Since June 1987, either an emergency air-lock seal has been replaced or a door adjusted five times for Unit 1 and five times for Unit 2. Maximum path leakage rates for both Unit 1 and Unit 2 emergency air-locks have ranged from 0 to 9 scf/h.

Based on the above information, performance-based Type B testing would not result in a significant reduction in tests of the air-locks. In all cases except for the fuel transfer tubes, repairs have been performed on the air-lock seals often enough that they would not meet the performance requirements necessary to reduce their test intervals.

Grand Gulf

At NRC's April 1993 workshop (NRC93B), the operators (Entergy) of Grand Gulf Nuclear Station (GGNS) presented data on its experiences with Type B testing. GGNS has experienced 25 failures of Type B tests since 1986, with 17 of the failures occurring at the first refueling outage. This corresponds with a success rate of 95 percent since 1986, and 98 percent after the first refueling outage.

Subsequently, Entergy/Grand Gulf has submitted an application for exemption from 10 CFR 50 Appendix J requirements and proposed amendments to the operating license to implement a performance based containment leakage-testing program (GG93). Included in the application is the history of leakage-rate testing experience covering five refueling outages. This history includes a total of 482 Type B electrical penetration tests involving 92-100 components per outage, with 25 of the

tests exceeding administrative limits. Of the 18 Type B tested components that have failed at least once, 16 were guard pipe inspection ports. Table 4-3 presents the Grand Gulf Type B test data.

Grand Gulf also reports 2 air-lock test failures in 32 total tests. Additionally, no failures have been observed in a total of 489 air-lock seal tests. However, since the service life of air-lock door seals is five years, these components are not included in the performance-based testing program.

NUMARC

The previously cited NUMARC analysis includes 5008 Type B tests on a total of 1252 components, with 121 tests, 2.5% of the total, exceeding administrative limits. These data are presented in Table 4-4. Most of the tests exceeding administrative limits were on electrical penetrations; however, the leakages in all cases appear to be small and well below levels that could be considered potentially risk

significant. Air-locks are reported to have exceeded administrative limits 26 times, with ten of these cases reported to have component leakages that approach or exceed the overall allowable leakage for the containment. Quantification of leakages by individual test are not provided in the NUMARC summary. The observed leakages are said to be associated with seal degradation.

Again, the NUMARC results appear to be consistent with those based on the NRC data base (NRC93A). Electrical penetration leakages, when they occur, appear to be small and not risk significant; air-lock seal leakages apparently can be larger and may warrant more attention.

4.3 TYPE C LLRT

North Anna

Appendix A discusses the results of Type C testing of penetrations at North Anna Units 1 and 2.

Table 4-3. Grand Gulf Type B Performance Test Data

Refueling Outage No.	Total Components Tested	Total Failures	Percent Passes (Percent)
RF01	96	17	82
RF02	96	0	100
RF03	100	2	98
RF04	98	6	94
RF05	92	0	100
Total	482	25	95

Based on the above information, performance-based Type B testing could result in a significant reduction in the extent of electrical penetration testing.

Table 4-4. NUMARC Type B Performance Test Data

Component Test Type	Leakage-Rate Test Results Frequency				
	1-99 sccm	100-999 sccm	1,000- 9,999 sccm	10,000- 49,000 sccm	Over 50,000 sccm
Electrical Penetration	58	7	4	1*	-
Air-lock	-	-	5	11	10
Inspection Port	0	2	3	1	3
Equipment Hatch	0	3	1	1*	-
Blind Flange	3	2	1	0	0
Gibs	-	-	-	2*	-
Closed Loop	-	2	0	0	0
Bellows	0	1	0	0	0
Totals	61	17	14	16	13
Percentage (%)	50.4	14.0	11.7	13.2	10.7

* Test over 10,000 sccm; actual amount not reported or known.

Analysis of Data

Number of components in sample data base	1252
Number of tests in sample data base	5008
Number of tests exceeding administrative limits	121
Percentage of tests within administrative limits	97.5%
Percentage of tests exceeding administrative limits	2.5%

Tests Exceeding Administrative Limits By Type

Electrical Penetration Tests	70
Air-lock Tests	26
Inspection Port Tests	9
Equipment Hatch Tests	5
Blind Flange Tests	6
Gibs Tests	2
Closed Loop Tests	2
Bellows Tests	1
Total Number of Tests	121

North Anna Unit 1 and Unit 2 contain 91 penetrations and 92 penetrations, respectively, that are Type C tested. Based on the data in the appendix, approximately 17 percent of the valves tested had maintenance performed on them after testing. Of the valves maintained, approximately 20 percent had an indeterminable leakage rate during Type C leakage testing. The leakage-test equipment used during Type C testing can measure leakage rates up to approximately 257 scf/h. The overall containment leakage rate was indeterminable three times since 1986 due to all valves in a series path having an indeterminable leakage rate.

Although the minimum path leakage rates for the two units have not been larger than L_n (304 scf/h) since mid-1988, individual components have been found with leakage rates of 257 scf/h or more at all refueling outages except one. The number of such components found by Type C testing during refueling outages have ranged from 0 to 10. In several cases, additional such components were found during tests between refueling outages. In all cases since mid-1988, the containment minimum path leakage rate has not been affected because another component in series with the failed component has experienced no, or a small, leakage rate.

A statistical analysis was performed to determine if the time before maintenance for Type C tested valves could be predicted based on component and system data. This analysis, documented in Appendix A, concluded that no strong correlation could be found.

An analysis of the frequency of valve maintenance due to unacceptable leakage rates showed a frequency of approximately $2E-2$ maintenance events per year per valve. Considering only those valves leaking 250 scf/h or more, the frequency is approximately $7.6E-3$ maintenance events per year per valve. These failure rates assume that failure of a component is independent of previous failures of the component. The use of these failure rates over-estimates the probability of single valve failures

and under-estimates the probability of multiple valve failures. This indicates that once a valve fails, it is more likely to fail again. Based on the valve configurations associated with each unit's penetrations, an indeterminable containment leakage rate is expected approximately once every 26 unit-years of operation. Historically, three cases of indeterminable containment leakage rate have occurred in 27 unit-years of operation.

A detailed analysis of the North Anna data is presented in Appendix A.

Grand Gulf

At the NRC's April 1993 workshop, Entergy/Grand Gulf presented data on its experiences with Type C testing. GGNS has experienced 52 failures of Type C tests since 1986 from a population of 389 valves. This corresponds to a success rate for Type C components of 97 percent, with 86 percent of Type C components experiencing no failures.

The Grand Gulf Appendix J exemption request also includes a history of Type C leakage-test experience. A total of 1566 tests on 297 Type C components have been performed, with 52 failures observed. 255 of the Type C components have never failed. Most of the Type C test failures have been associated with the 14 main steam and feedwater isolation valves; these are 28 and 24 inches in diameter, respectively. The leakage rates for the later components have apparently often exceeded the measuring capacity of the test equipment. These data are presented in Table 4-5.

It is noteworthy that for Type B & C testing at GGNS, failure is defined as exceeding the owner's allowable leakage for a particular component. Each component is assigned an allowable leakage rate based on the diameter of the component. Thus, components can be considered failed even though the overall containment leakage rate is within acceptable limits.

Table 4-5. Grand Gulf Type C Performance Data

Refueling Outage No.	Total Components Tested	Total Failures	Percent Passes (Percent)
RF01	301	13	96
RF02	326	8	98
RF03	316	16	95
RF04	326	9	97
RF05	297	6	98
Total	1,566	52	97

An analysis of the Grand Gulf data is presented in Appendix A. A summary of Grand Gulf's performance-based leakage-testing program for Type B and C components, which is based on the data discussed above and the NRC's review of its exemption request, is provided in Appendix F.

NUMARC

The NUMARC summary of Type C test experience indicates that 90% of valves tested in the sample set of units surveyed (29 units) did not exceed established administrative limits for leakage. Of the 10% of valves that exceeded these limits, 63% did so only once, with 37% of the valves tested exceeding administrative limits more than once. Approximately 14% of the tests exceeding administrative limits had unquantified leakages. The range and frequency of valves exceeding administrative limits are presented in Table 4-6.

NUMARC states that valve performance did not indicate significant variance among sizes, types, or design services. The same conclusion was reached from the analysis of North Anna valve performance in the present study. The NUMARC data are presented in Table 4-7.

4.4 PERFORMANCE TRENDS

An extensive analysis of available Type C and Type B data at two nuclear power plants is documented in Appendix A. One of the early objectives of the component performance history analysis described in Appendix A was the development of correlations of component performance characteristics with time. Such correlations would permit the projection of individual component and overall containment performance for longer testing intervals than those used in the past. The sections to follow summarize the findings on why failures occur, including the effects of aging.

Random and Dependent Failures

The detailed analysis of the Type C component performance history at two-unit PWR and a single-unit BWR led to the following findings.

- Variations in the random failure rates of components cannot be predicted a priori based on system and component physical data such as differences in size, type, environment, or design services.

Table 4-6. Type C Valves Exceeding Administrative Limits

Leakage-Rate Range in Thousands of scfm	Number of Tests
0.49 or less	84
0.50 to 0.99	105
1.00 to 2.49	205
2.50 to 4.99	114
5.00 to 9.99	102
10.00 to 24.99	104
25.00 to 49.99	36
50.00 to 99.99	37
100.00 to 499.00	30
500.00 or more	18
Undetermined	136
Total	971

- When a component failure does occur, there is a high probability that the component will fail again within the next two operating cycles.
- If a component does not fail within two operating cycles of a previous failure, further failures appear to be governed by the random-failure rate of the component.
- Any performance-based leakage-testing alternative considered should require that a failed component pass at least two consecutive tests before allowing an extended test interval.

The observed tendency for some components to experience successive failures could be due to a variety of reasons. Among these would be the selection of a wrong component for the particular service; an initially defective component; deficiencies in component design; and, defective installation, maintenance, or

repair procedures. Components that experience repeated failures will generally receive special attention and the foregoing deficiencies would be eliminated with time. For example, a number of the early unquantified leakages observed at North Anna were due to machining errors that led to excessive valve seat wear. Once the problem was recognized, it was readily corrected. Similarly, most of the Type B failures observed at Grand Gulf were associated with the design of the guard pipe inspection ports. These are corrected, as excessive leakages are experienced, and subsequent performance is improved. After such deficiencies are corrected, subsequent failures are governed by random failure rates until the component reaches the wear-out portion of its life.

Performance-based testing alternatives, that are predicated on components passing two successive tests before extending the testing interval, will minimize testing of good performers and will thus focus on those

Table 4-7. NUMARC Type C Performance Data

VALVE TYPE	NUMBER AND FREQUENCY OF VALVES/TESTS EXCEEDING ADMINISTRATIVE LIMITS				
	1 Time	2 Times	3 Times	4 Times	5 Times
BUTTERFLY	36	14	7	2	0
	992 Butterfly Valve Tests				
	93 Tests of 59 Valves Exceeded Administrative Limits				
CHECK	87	35	16	3	1
	1360 Check Valve Tests				
	222 Tests of 142 Check Valves Exceeded Administrative Limits				
GATE	50	24	8	3	0
	1672 Gate Valve Tests				
	134 Tests of 85 Valves Exceeded Administrative Limits				
GLOBE	131	34	24	7	2
	3760 Globe Valve Tests				
	309 Tests of 198 Valves Exceeded Administrative Limits				

components that suffer some kind of deficiency or reach wear-out. If all component failures were truly random, for a given performance-based testing scheme, the minimum amount of additional testing would be required to verify such random behavior.

Aging

The analyses described in Appendix A found a correlation which showed a higher failure rate immediately after component repair or replacement, i.e., during the "burn-in" period of the component. The fact that containment penetration components have been tested, maintained, repaired, and replaced at regular

intervals accounts at least in part for the difficulty in projecting long-term performance. Since the condition of many of the components is reset to their initial state (or better), there is no information of what their long term performance might be. The statistical projections of component performance for various testing alternatives were made on the basis of constant failure rates after the initial burn-in period.

The Appendix A examination of Type B and C component performance clearly indicates that excessive containment penetration leakages are more frequent early in plant life and decrease with time. The reason for the observed behavior

Test Experience

is generally understood. When repeated failures of certain components are observed, the problems are remedied by changing design, materials, or replacing the troublesome component with a different design, or improved repair procedures. This is known as the burn-in portion of plant life.

With the possibility of longer type B and C component testing intervals the question arises whether any containment penetration components may be nearing the "wear-out" portion of their life. The Appendix A analyses do not show any increases in component failure rates with time. To shed light on this issue, GGNS has performed a Weibull analysis of Type C component test data (GG94). The data show 41 initial failures in 134 components over a period of 109 months, or 30.6% cumulative failures. The data presented also show that 17 of these 41

components have experienced at least one additional failure. The correlation by the Weibull analysis of the observed data by a beta less than one does suggest that the failure rate is decreasing over the time interval. The data are limited and show some scatter, however. Examination of the North Anna Type C component failure data lead to a similar conclusion. Again, the data are relatively sparse and exhibit considerable scatter.

The experiences at North Anna and Grand Gulf, as well as the NEI data summary, indicate that a majority of Type C components have never failed. This and the results of the Weibull analysis indicate that the wear-out portion of the component life has not been reached, and may not be reached provided good maintenance practices continue to be followed.

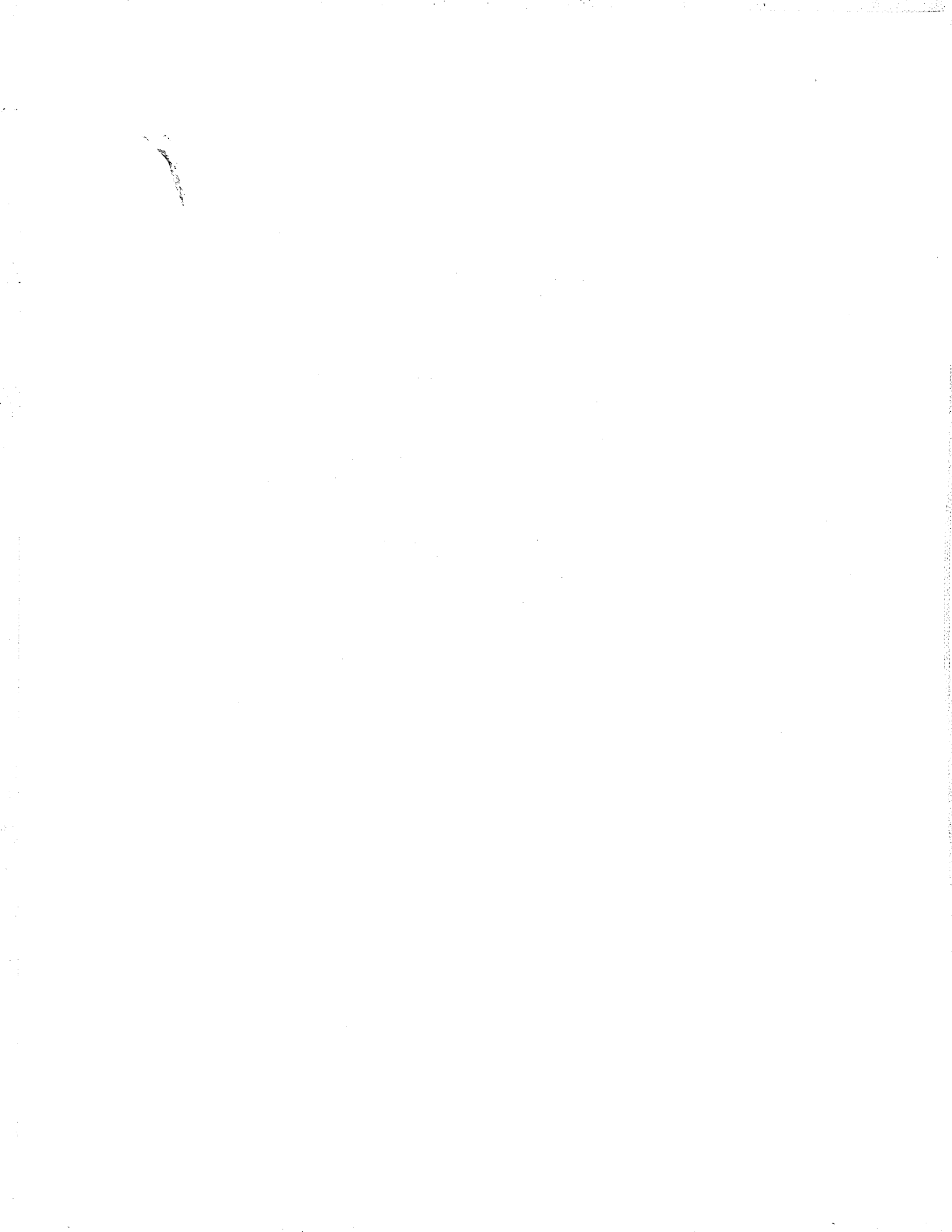

5. Risk Impacts of Containment Leak-tightness

5.1 REVIEW OF EARLIER WORK ON RISK IMPACTS OF CONTAINMENT LEAKAGE RATE - NUREG/CR-4330

NUREG/CR-4330 (NRC86) examined the risk impacts associated with increasing the allowable containment leakage rate using two different methods. The first method used several existing PRAs and calculated the incremental risk due to increasing the allowable containment leakage rate. The risk measure used in this first approach is "expected person-rem per year" (i.e., the probability of an accident multiplied by its consequences in terms of person-rem to the surrounding population). The second approach examined selected accident sequences and considered several additional measures including individual radiation exposures and early health effects.

The purpose of these studies was to provide information on the possible risks, costs, and benefits that would result if the requirements for testing containment leakage rates were modified. The following summarizes the results presented in NUREG/CR-4330, Volume 2.

5.1.1 Existing PRAs

Risk results were examined for four different reactors: Surry 1, Peach Bottom 2, Oconee 3, and Grand Gulf 1. The applicable release categories and their associated frequencies determined the impact of increasing the containment leakage rate. Appendix A of NUREG/CR-4330, Volume 2 briefly describes each release category. Calculations were based on the following information and assumptions:

- Accident frequencies were obtained from the Reactor Safety Study (Surry 1 and Peach Bottom 2) (NRC75) and two probabilistic risk assessments (Oconee 3 and Grand Gulf 1) performed as part of the Reactor Safety Study Methodology Applications Program (RSSMAP) (NRC81).
- Dose consequences were represented by the whole body population dose commitment (person-rem/reactor-year) received within 50 miles of the site.
- A generic site with an exclusion area of 1/2 mile was assumed with uniform population density of 340 persons per square mile beyond 1/2 mile.
- Meteorological data were taken from the U.S. National Weather Service station at Moline, Illinois. The CRAC2 computer code was used (NRC83, NRC84). CRAC2 uses weighted values of wind speed and direction, stability class, precipitation, etc., pertaining to the selected weather station. There may be a large stochastic variation in results associated with the actual meteorology at the time of a radiological release.
- The core inventory at the time of the accident was assumed to be represented by a 3412 MWt (1120 MWe) PWR.
- Risk sensitivity values were obtained from a study by Oak Ridge National Laboratory (NRC84A). The ORNL analysis of containment leakage-rate sensitivity used a set of generic source terms and frequencies of occurrence developed as representative of the range of LWR accidents.

The release category, frequency, population dose, and expected population dose (risk) information for the four units described are summarized in Table 5-1.

To estimate the risk associated with an increased leakage rate, a fractional increase in risk per percent per day containment leakage rate was obtained from an earlier study (NRC84A). The analysis, based on a study of LWR accidents as a function of containment leakage rates, used the set of generic source terms and frequencies of occurrence developed as representative of the

Table 5-1. Risk Information Summary

Release Categories	Frequency per year	Population Dose, (person-rem/year)	Expected Dose (Risk), (person-rem/year)
SURRY 1			
PWR-1	9E-7	5.4E6	4.86
PWR-2	8E-6	4.8E6	38.40
PWR-3	4E-6	5.4E6	21.60
PRW-4	5E-7	2.7E6	1.35
PRW-5	7E-7	1.0E6	0.70
PWR-6*	7E-6	1.5E5	0.90
PWR-7*	4E-5	2.3E3	0.09
PWR-8	4E-5	7.5E4	3.00
PWR-9*	4E-4	1.2E2	0.05
			71 Total
PEACH BOTTOM 2			
BWR-1	1E-6	5.4E6	5.40
BWR-2	6E-6	7.1E6	42.60
BWR-3	2E-5	5.1E6	102.00
BWR-4*	2E-6	6.1E5	1.22
BWR-5*	1E-4	2.0E1	0.002
			151 Total
OCONEE 3			
PWR-1	1.1E-7	5.4E6	0.59
PWR-2	1.0E-5	4.8E6	48.0
PWR-3	2.9E-5	5.4E6	156.6
PWR-4	9.7E-8	2.7E6	0.26
PWR-5	4.6E-7	1.0E6	0.46
PWR-6*	7.3E-6	1.5E5	1.1
PWR-7*	3.5E-5	2.3E3	0.08
			207 Total
GRAND GULF 1			
BWR-1	1.1E-7	5.4E6	0.59
BWR-2	3.4E-5	7.1E6	241.4
BWR-3	1.4E-6	6.1E5	7.14
BWR-4*	1.6E-6	6.1E5	0.98
			250 Total

* Containment leakage release category

range of postulated types of accidents currently applied in reactor safety research. The calculated result was the variable M_{sp} , defined as the accident-spectrum-weighted impact fraction rate from containment building leakage. Explicitly, M_{sp} was formulated as the sum of fractional increases in consequences, due to containment building leakage, for each type of accident weighted by its frequency of occurrence. The base case common to similar types of analyses was applied. The computed result was $M_{sp} \leq 1.5E-3$ fractional increase in the accident spectrum risk per percent/day containment building leakage rate.

Table 5-2 shows the estimated dependence of risk (population dose in person-rem per unit year) to leakage rate based on the four units considered.

This information, graphically presented in Figure 5-1, shows that the overall unit risk is not very sensitive to changes in containment leakage rates. A key assumption was that pre-existing leakage does not influence the accident sequence propagation (e.g., it does not significantly influence the containment pressure/temperature conditions or result in equipment failures). While the validity of this assumption has not been exhaustively evaluated, it is consistent with the findings in WASH-1400. WASH-1400 (NRC75) examined this issue for the Surry unit with the conclusion that pre-existing leakage rates of up to 200 percent per day would not preclude containment failure by slow overpressurization.

Further, sensitivity analyses in NUREG/CR-4330 (NRC86) showed that LWR accident risk is relatively insensitive to the containment leakage rate because the risk is dominated by accident sequences that result in failure or bypass of containment. The incremental risk from leakage in the range of 1 to 10 percent per day is small. The current leakage-rate requirements of many units are 0.1 percent per day.

5.1.2 Selected Accident Scenarios

The second approach used in NUREG/CR-4330 analyzed two specific PWR and two specific BWR accident scenarios from WASH-1400, and a hypothetical scenario related to the Three Mile Island (TMI) accident to indicate the impacts of various assumed containment leakage rates for the selected accident scenarios.

The two PWR scenarios fell under release categories PWR-6 and PWR-7 in Table 5-1. The reference consequences were based on a leakage rate of 1 percent of containment volume per day; the WASH-1400 fission product releases for these were linearly scaled to obtain values for 10 and 100 percent per day leakage rates. The consequences were then reassessed with CRAC2. Not surprisingly, the consequences were found to vary essentially linearly with leakage rate. Whereas the previous analyses noted no early health effects, the assumed 100 percent per day leakage rate led to the calculation of some early injuries and fatalities. However, the particular scenario considered had a very low probability and would

Table 5-2. Dependence of Risk on Containment Leakage Rate

PWR Leakage Rate (%/day)	Expected Population Dose (person-rem/reactor-year)		BWR Leakage Rate (%/day)	Expected Population Dose (person-rem/reactor-year)	
	Surry 1	Oconee 3		Peach Bottom 2	Grand Gulf 1
1.0	71	207	0.5	151	250
10.0	72	210	5.0	153	254
100.0	82	238	50.0	174	288

Risk Impact

not be risk significant even at the assumed 100 percent per day leakage rate. The results for the two BWR scenarios considered were substantially similar to the observations for the PWR cases.

5.1.3 TMI-Related Scenario

A sequence similar to the Three Mile Island 2 accident was examined to provide some additional insight into the effects of changes in containment leakage rates. An arbitrary source term of all noble gases and 1 percent of the iodine in the core were assumed to be released to the containment atmosphere 2 hours after shutdown. The probability of such a release is assumed to be $1E-3$ per year. The computer program CRAC2 (NRC84) was used to calculate the consequences for leakage rates of 0.1, 1, 10, and 100 percent of containment volume per day for release periods of 2 and 10 hours. Since no decay is assumed, the results are proportional to the length of the release period. The risk is expressed in terms of expected person-rem, expected early fatalities, and expected early injuries. Consistent with the other analyses, the risk impact of a 1 or 10 percent per day leakage rate is not large. Also, no early fatalities result from leakage rates up to 100 percent per day, and the risk of early injuries is small.

5.1.4 Conclusions Reached in NUREG/CR-4330

The results from NUREG/CR-4330 reinforced the conclusion of earlier studies: *the effect of containment leakage on overall accident risk is small since risk is dominated by accident sequences that result in failure or bypass of containment.* For accidents in which the containment integrity remains intact, the effect of containment leakage on risk is small and approximately linear. On an expected individual dose basis, the effect of containment leakage is small.

Given these findings, and considering the costs associated with leakage testing, NUREG/CR-

4330 concluded that incentives exist to re-evaluate the risk significance of Appendix J requirements.

5.2 RISK IMPACTS

5.2.1 Approach

Appendix B, "Approach to Assessing Risk Impacts," provides a more detailed explanation of the risk assessment methodology used in NUREG-1150 (NRC90) and the approach taken in the present study to update the NUREG/CR-4330 (NRC86) results based on NUREG-1150. A summary is provided below.

The NUREG/CR-4330 insights were based on the results of the Reactor Safety Study (RSS) and the Reactor Safety Study Methods Application Program (RSSMAP). The purpose of this update is to incorporate the latest PRA results, notably those in NUREG-1150 and related supporting documentation, namely the NUREG/CR-4550 (NRC90A) and -4551 (NRC90B-F) series of reports.

In the Reactor Safety Study, source terms were developed for nine release categories for the Surry unit. Each of these release categories could be characterized by a particular containment failure mode. Point estimates for release fractions for seven elemental fission product groups were then used to characterize each category. Specific consequence calculations were then performed for each of the release categories. This approach made it easy to evaluate the relative contributions to the consequences of the different containment failure modes, as was done in NUREG/CR-4330, Volume 2.

In NUREG-1150, a number of unit damage states, related to the initiating accident events, were developed for each of the five units considered. Each of these unit damage states could lead to a variety of accident progression bins, depending on the phenomenological

assumptions used in the statistical treatment of uncertainties. For example, the Surry unit analyses for NUREG-1150 considered 7 unit damage states, 1906 accident progression bins, and 200 statistical samples for each combination. A source term consisting of nine elemental groups was developed for each non-zero probability combination of unit damage state and accident progression bin, leading to approximately 32,000 combinations. Since it was impractical to perform consequence analyses for each of the source terms, they were allocated to a smaller number of source term groups, 52 in the case of Surry. Specific consequence analyses were then performed for each of these source term groups.

Original computer files generated in the preparation of NUREG-1150 were accessed. Four files for each unit were found to be required: (1) the definition of the accident progression bins, (2) the frequencies of each of the unit damage states and their relationship to the relevant accident progression bin as well as

bin probabilities, (3) the expected consequences for each of the 52 source term groups, and (4) the relationship between each unit damage state and accident progression bin to its appropriate source term group.

The information extracted from each set of the above files included the frequencies and expected consequences of each of the source term groups for the base case which included all unit damage states and accident progression bins, the combinations with no containment failure or bypass, and the combinations with containment isolation failure, i.e., pre-existing leakage.

The off-site consequence analyses for NUREG-1150 were performed with MACCS (MELCOR Accident Consequence Code System). MACCS calculates a variety of early, as well as chronic, offsite consequence measures. Latent effects are of primary interest for the present study; the consequence measures used are defined in Table 5-3.

Table 5-3. Definitions of Consequence Analysis Results

Variable	Definition
Total latent cancer fatalities	Number of latent cancer fatalities due to both early and chronic exposure.
Population dose within 50 miles	Population dose, expressed in effective dose equivalent for whole body exposure (person-rem, 1 Sv = 100 Rem), due to early and chronic exposure pathways within 50 miles of the reactor. Due to the nature of the chronic pathways models, the actual exposure due to food and water consumption may take place beyond 50 miles.
Population dose within entire region	Population dose, expressed in effective dose equivalents for whole body exposure (person-rem), due to early and chronic exposure pathways within the entire region.
Individual latent cancer risk within 10 miles	The probability of dying from cancer due to the accident for an individual within 10 miles of the unit (i.e., $\sum (cf/pop)p$, where cf is the number of cancer fatalities due to direct exposure in the resident population, pop is the population size, p is the weather condition probability, and the summation is over all weather conditions; chronic exposure does not include ingestion but does include integrated groundshine and inhalation exposure from $t = 0$ to $t = \infty$).

Risk Impact

The base case results, representing total accident risk, repeated what had originally been done and were checked against the published results to verify the correct usage of the data files. The combinations with no containment failure or bypass were used to characterize the risk contribution of the assumed normal (1% per day) containment leakage rate. Subtracting the contribution of the no containment failure cases from the base case gave the results for zero containment leakage. The results for isolation failure were used to derive the expected consequences of a pre-existing large leakage. Using the expected consequences for a large leak together with the probability of no containment failure yielded the potential risk contribution of a large pre-existing leak. These three points were plotted as leakage rate or leakage area versus expected risk and a curve was fitted through the points. It was found that a second order polynomial would accurately reproduce the three points. This polynomial fit was then used to estimate risk impacts of leakage rates above the nominal that had been used in the original analyses.

5.2.2 Results

This section presents the results of a study of the dependence of reactor accident risks on containment leak-tightness for each of the five reactor/containment types analyzed in NUREG-1150. These include:

- Unit 1 of the Surry Power Station, a Westinghouse-designed, three-loop, pressurized water reactor in a subatmospheric containment building
- Unit 2 of the Peach Bottom Atomic Power Station, a General Electric-designed, boiling water (BWR-4) reactor in a Mark I containment building
- Unit 1 of the Sequoyah Nuclear Power Plant, a Westinghouse-designed, four-loop, pressurized water reactor in an ice condenser containment building
- Unit 1 of the Grand Gulf Nuclear Station, a General Electric-designed, boiling water (BWR-6) reactor in a Mark III containment building
- Unit 1 of the Zion Nuclear Plant, a Westinghouse-designed, four-loop, pressurized water reactor in a large, dry containment building

A summary of the information extracted from the detailed NUREG-1150 results for each of the five units and the consequence results is presented in Table 5-4. The results for each of the units are discussed below.

5.2.2.1 Surry

Figures 5-2 through 5-4 present the curves relating the risk measures as a function of containment leakage rate and effective leakage area for the Surry unit; the risk measures considered are total population exposure per year, total latent cancer fatalities per year, and individual latent cancer risk per year. Increasing the containment leakage rate from the nominal 1 percent per day to 10 percent per day leads to about 1 percent increase in total population exposure; increasing the leakage rate to 100 percent per day leads to a 56 percent increase in total population exposure.

As reported in NUREG-1150 (NRC90), the expected population dose from potential accidents at the Surry unit was calculated as 31 person-rem/year, with a corresponding latent cancer expectation of $5.2E-3$ per year. The individual latent cancer risk was found to be $1.7E-9$ per year. Containment leakage, at an assumed rate of 1 percent per day, was found to contribute approximately 0.05 percent to these totals.

The design basis leakage rate for the Surry unit is nominally 0.1 percent per day. However, the technical specifications for the unit allow limited time operation with up to 1 percent per day containment leakage rate. Also, as noted

Table 5-4. Summary of Risk Analysis Results

Unit	Case	Total latent cancer fatalities (/yr)	Population dose within entire region (person-rem/yr)	Individual latent cancer risk <10 miles/yr
Surry (Subatmospheric, PWR)	1. No containment failure with leakage rate at 1%/day	1.89E-06	1.79E-02	6.97E-13
	2. Early containment leakage of 0.1 sq ft area	4.20E-06	2.48E-02	1.35E-12
	3. Base Case	5.18E-03	3.10E+01	1.74E-09
Peach Bottom (Mark I, BWR)	1. No containment failure with leakage rate at 0.5%/day	6.66E-07	4.85E-03	6.49E-13
	2. Early containment failure with drywell head leakage	1.89E-09	1.29E-05	3.46E-16
	3. Early containment failure with drywell leakage	1.08E-08	6.79E-05	1.46E-15
	4. Early containment failure with wetwell leakage	3.99E-08	2.56E-04	1.22E-14
	5. Base Case	4.60E-03	2.83E+01	4.29E-10
Sequoyah (Ice Condenser Containment, PWR)	1. No containment failure with leakage rate at 1% per day	3.83E-06	3.93E-02	1.69E-12
	2. Early containment leakage of 0.1 sq ft area	1.15E-04	6.59E-01	8.35E-11
	3. Base Case	1.36E-02	7.97E+01	1.00E-08
Grand Gulf (Mark III, BWR)	1. No containment failure with leakage rate at .5%/day	1.55E-07	1.53E-03	1.01E-13
	2. Early containment leakage of 0.1 sq ft area	4.18E-05	2.56E-01	1.71E-11
	3. Early containment vent	5.51E-06	3.33E-02	1.14E-12
	4. Base Case	9.24E-04	5.66E+00	3.29E-10
Zion (Large Dry Containment, PWR)	1. No containment failure with leakage rate at 0.1%/day	1.87E-05	0.156	9.96E-12
	2. Early containment leakage of 0.1 sq ft area	5.60E-04	7.07	4.67E-10
	3. Base Case	2.44E-02	135.6	1.09E-08

Risk Impact

elsewhere in this report, in the risk assessment small deviations from the nominal leakage rate were treated as nominal. For these reasons, both the Reactor Safety Study as well as the more recent NUREG-1150 analyses assumed a leakage rate of 1 percent per day in the accident progression and source term analyses. Thus, the calculated risk contribution already incorporates a significant allowance for greater than nominal leakage rate.

Figure 5-5 compares of the calculated individual latent cancer fatality risk for Surry as a function of containment leakage rate with the NRC's safety goal. The risk is well below the safety goal for the entire range of leakage rates considered.

The NUREG-1150 analyses for Surry considered explicitly early (pre-existing) leakage paths of 0.1 ft² in area; assuming critical flow through an orifice, this would imply an orifice about 4.3 inches in diameter with a corresponding leakage rate at design pressure of about 280 percent per day. The probability of containment isolation failure for Surry was assessed in NUREG-1150 as 2E-4 per year (NRC90B). Containment isolation failure contributes less than 0.1 percent of the latent risks from reactor accidents. This low level of risk contribution is due to the low predicted probability of isolation failure; the consequences of containment isolation failure in the event of a severe accident can be substantial.

5.2.2.2 Peach Bottom

Figures 5-6 through 5-8 present the curves relating the risk measures as a function of containment leakage rate and effective leakage area for Peach Bottom; the risk measures considered are total population exposure per year, total latent cancer fatalities per year, and individual latent cancer risk per year. Increasing the containment leakage rate from the nominal 0.5 percent per day to 5 percent per day leads to a barely perceptible increase in total population exposure; increasing the leakage rate to 50 percent per day increases the total population

exposure by less than 1 percent. The significantly lower sensitivity of the calculated Peach Bottom risk as compared to Surry is due to the higher containment failure probability for Peach Bottom; since the containment is predicted to fail in a large fraction of core melt scenarios, leakage becomes a lesser consideration. Also, in BWRs, the fission product releases undergo scrubbing by the suppression pool even in many scenarios in which the containment may not be isolated. The expected population dose from potential accidents at Peach Bottom was calculated as 28 person-rem/year, with a corresponding latent cancer expectation of 4.6E-3 per year. The individual latent cancer risk was found to be 4.3E-10 per year. Containment leakage rate, at an assumed rate of 0.5 percent per day, was found to contribute approximately 0.02 percent to these totals.

Figure 5-9 compares the individual latent cancer fatality risk for Peach Bottom as a function of containment leakage rate with the NRC's safety goal. The risk is well below the safety goal for the entire range of leakage rates considered.

5.2.2.3 Sequoyah

Figures 5-10 through 5-12 present the curves relating the several risk measures as a function of containment leakage rate and effective leakage area for Sequoyah. Increasing the containment leakage rate from the nominal 1 percent per day to 10 percent per day leads to a less than 1 percent increase in total population exposure; increasing the leakage rate to 100 percent per day leads to an 8 percent increase in total population exposure. The Sequoyah results show a lower sensitivity to containment leakage rate compared with the Surry results because of a higher predicted early containment failure probability for Sequoyah.

As reported in NUREG-1150, the expected population dose from potential accidents at Sequoyah was calculated as 80 person-rem/year, with a corresponding latent cancer expectation of 1.4E-2 per year. The individual latent cancer

risk was found to be $1.0E-8$ per year. Containment leakage, at an assumed rate of 1 percent per day, was found to contribute approximately 0.05 percent to these totals.

Figure 5-13 compares the individual latent cancer fatality risk as a function of containment leakage rate with the NRC's safety goal. The risk is well below the safety goal for the entire range of leakage rates considered.

5.2.2.4 Grand Gulf

Figures 5-14 through 5-16 present the curves relating the several risk measures as a function of containment leakage rate and effective leakage area for Grand Gulf. Increasing the containment leakage rate from the nominal 0.5 percent per day to 5 percent per day leads to less than 1 percent increase in total population exposure; increasing the leakage rate to 50 percent per day increases the total population exposure by about 3 percent. The calculated Grand Gulf risk shows significantly lower sensitivity than the Surry risk because of the higher containment failure probability for Grand Gulf; since the containment is predicted to fail in a large fraction of core melt scenarios, leakage rate becomes a less important consideration. Also, in BWRs, the fission product releases undergo scrubbing by the suppression pool even in many scenarios in which the containment may not be isolated.

The expected population dose from potential accidents at Grand Gulf was calculated as 5.7 person-rem/year, with a corresponding latent cancer expectation of $9.2E-4$ per year. The individual latent cancer risk was found to be $3.3E-10$ per year. Containment leakage, at an assumed rate of 0.5 percent per day, was found to contribute approximately 0.02 percent to these totals. Figure 5-17 shows the comparison of individual latent cancer fatality risk for Grand Gulf as a function of containment leakage rate with the NRC's safety goal. The risk is well below the safety goal for the entire range of leakage rates considered.

5.2.2.5 Zion

Figures 5-18 through 5-20 present the curves relating the several risk measures as a function of containment leakage rate and effective leakage area for the Zion unit. Increasing the containment leakage rate from the nominal 1 percent per day to 10 percent per day leads to about a 3 percent increase in total population exposure; increasing the leakage rate to 100 percent per day leads to an approximately 250 percent increase in total population exposure. These results are similar to Surry's.

As reported in NUREG-1150, the expected population dose from potential accidents at the Zion unit was calculated as 136 person-rem/year, with a corresponding latent cancer expectation of $2.4E-2$ per year. The individual latent cancer risk was found to be $1E-8$ per year. Containment leakage, at an assumed rate of 1 percent per day, was found to contribute approximately 0.1 percent to these totals.

Figure 5-21 compares the individual latent cancer fatality risk as a function of containment leakage rate with the NRC's safety goal. The risk is well below the safety goal for the entire range of leakage rates considered.

5.2.2.6 Discussion

Table 5-5 compares the fission product source terms associated with a normal leakage rate with those resulting from an early large leak (isolation failure) for Surry. Normal leakage rate was taken to be nominally 1 percent per day at the design pressure. The early leakage was characterized by a 0.1 ft^2 opening. The source terms presented have been probability weighted over all the source term groups associated with them. The fission product source terms are given as fractions of the core inventory released from the containment.

Recalling that the 0.1 ft^2 opening corresponds to a leakage rate of about 280 percent per day, it

Table 5-5. Comparison of Source Terms

Fission Product Group								
Ng	I	Cs	Te	Sr	Ru	La	Ce	Ba
No Containment Failure, 1%/day Leakage Rate								
.011	1.1E-4	2.1E-8	1.8E-8	4.2E-9	3.4E-10	4.6E-11	5.2E-10	3.5E-9
Early Containment Leakage, 0.1 ft ²								
.44	.075	.064	.036	.0037	8.6E-4	3.1E-4	9.5E-4	.0038

can be seen that the fission product source terms are not directly proportional to the leakage rate. Among the factors that would influence the magnitude of the releases are: availability of driving forces for leakage, timing of releases relative to the timing of driving forces, fission product removal by sprays, water pools, etc.

At small leakage rates, the loss from the containment atmosphere of gases and vapors, as well as airborne fission products, will have very little influence on accident progression or the inventory available for leakage. Thus, at small leakage rates, one would expect the releases to be proportional to the leakage rate. As the leakage rate increases, the losses from the containment atmosphere may begin to affect the accident progression. For example, containment pressure-time history and magnitude of fission product release could decrease the residence time of airborne species in the containment atmosphere. If leakage is sufficient to compete with other fission product removal processes, the magnitude of the leakage may increase disproportionately with the leakage rate. This is reflected in the results presented here for Surry. The magnitude of the release to the environment cannot increase indefinitely with assumed leakage rate since the inventory available for leakage is limited. For an infinitely large leakage rate, everything released to the containment atmosphere would also be released to the environment. Further discussion of the dependence of fission product releases to the environment on containment leakage rate is provided in Appendix E.

It is instructive to consider some specific items from Table 5-5. The noble gases are not subject to removal by deposition or engineered safety features; thus, their radioactive decay is not considered in the containment response analysis but is included in the off-site consequence calculations. The release of the noble gases (Xe, Kr) increases by a factor of 40 between the nominal leakage and containment isolation failure cases. The relative increases in the releases for the other species are substantially larger; the fractional releases of the other species are, of course, much smaller due to the influence of various deposition mechanisms. The relative increases in the releases of iodine and the other species in comparison with the noble gases indicates clearly that the large leakage is dominating the other fission product removal mechanisms. The increases in releases vary with the fission product group. This is due to differences in the relative timing of the releases as well as to differences in chemical behavior among the groups.

In considering the effects of containment isolation failure on reactor accident progression for the Surry unit, the RSS examined a range of leakage rates with the conclusion that pre-existing leakage rates of less than about 200 percent per day would have little effect on the containment response. For critical flow through an orifice, a leakage rate of 200 percent per day corresponds to a 3.6-inch diameter opening in the containment shell. Under the assumption of critical flow, leakage rates would scale directly with leakage area. Pre-existing leakage rates

greater than this value would affect containment response by precluding other failure modes such as long-term over-pressurization. Thus, leakage rates of this magnitude and smaller were grouped with intact containment. Pre-existing leakage paths of greater than 200 percent per day were considered to constitute containment isolation failure. The probability of containment isolation failure for Surry was assessed by the RSS to be 2E-3. For purposes of fission product source term evaluation, the range of all possible isolation failure sizes was characterized by a leakage rate of 1000 percent per day, corresponding to an opening 8 to 10 inches in diameter.

Using assumptions similar to those of the RSS, the early (pre-existing) leakage path of 0.1 ft² in area explicitly addressed by NUREG-1150 corresponds to an orifice about 4.3 inches in diameter with an associated leakage rate at design pressure of about 280 percent per day. The probability of containment isolation failure for Surry was assessed in NUREG-1150 as 2E-4.

These observations are quite consistent with earlier studies on source term predictions for various containment failure assumptions. In this study (BMI86), the effects of various accident-induced containment leakage paths on accident progression and fission product source terms were addressed. It was found that accident-induced leakages equivalent to 0.6 to 1.8 in² in area had little effect on accident progression and that the fission products released to the environment were proportional to the size of the opening. In contrast, pre-existing containment isolation failures 6 inches in diameter were seen to have a significant effect on containment pressure-time history and could lead to disproportionately large releases.

5.2.3 Comparison with Earlier Results

Table 5-6 compares the results of the present work with those given in NUREG/CR-4330, Vol. 2, for Surry, Peach Bottom, and Grand Gulf, the three units common to both studies. The measure of risk employed for this comparison is total population exposure in person-rem per reactor year.

Table 5-6. Comparison of Results

Leakage Rate, %/day	Population Dose, person-rem/reactor-year					
	Surry		Peach Bottom		Grand Gulf	
	NUREG/CR-4330	Present Work	NUREG/CR-4330	Present Work	NUREG/CR-4330	Present Work
0.5	-	-	151	28.3	250	5.66
1	71	31.0	-	-	-	-
5	-	-	153	28.3	254	5.67
10	72	31.3	-	-	-	-
50	-	-	174	28.4	288	5.81
100	82	48.4	-	-	-	-

Risk Impact

Several notable points arise from this comparison. First, the overall levels of risk in the present study are lower than those previously calculated; this is quite consistent with the NUREG-1150 conclusion that risk estimates should be lower than those in WASH-1400. Second, the present work shows more sensitivity of risk to containment leakage rate for Surry, but less for Peach Bottom and Grand Gulf. This difference is due in part to the earlier study's use of a constant risk dependence on leakage for all the units. The present effort derived separate factors for each unit from the NUREG-1150 results. The difference between Surry and the two BWRs is also attributable to the fact that, for Surry, the containment does not fail in 81 percent of core melt scenarios, whereas the BWRs have a higher probability of containment failure; only when the containment stays intact is leakage potentially significant.

Among the many other reasons for the differences in the quantitative results of the two studies are:

- Accident sequence frequency. The median core damage frequency for Surry in NUREG-1150 is somewhat lower than the corresponding result in the RSS; however, the uncertainty bands on core damage frequency overlap. These differences are explained by differences in the unit systems over the time period between the two studies and significant advances in the state of the art in probabilistic analyses for nuclear power units.
- Source term characterization. The Reactor Safety Study developed source terms for nine release categories for the Surry unit. These release categories are directly analogous to the accident progression bins in NUREG-1150. A point estimate for release fractions for seven elemental fission product groups was then used to characterize each category. In NUREG-1150, source terms were developed for a much larger number of

accident progression bins. A distribution of release fractions was developed for each of the nine elemental groups corresponding to the individual statistical sample members of the uncertainty analysis. For these and other reasons, it is difficult to draw broad inferences about the source terms of the two studies. However, for the early containment failure bins that have the greatest impact on risk, the RSS source terms appear to be larger than the mean values of NUREG-1150 and are typically near the upper bound of the uncertainty range.

- Site-specific consequence analyses. NUREG-1150 performed site-specific analyses instead of adopting the generic site characteristics used in the earlier studies. This will directly affect the quantitative results, all other differences aside.
- Health effects models. The current models have been substantially upgraded from earlier versions.
- Evacuation and protective action models. These factors have a greater effect on acute effects than on overall population exposure. Latent cancer risks are sensitive to the assumed levels of interdiction of land and crops.
- Risk Characterization. The earlier study assumed a linear dependence of risk on containment leakage rate based on the analysis of Hermann et. al.; the present study derived a non-linear dependence based on NUREG-1150 results.

In spite of the differences in the bases of the two studies, the qualitative results are quite similar.

5.2.4 Discussion of Uncertainties

Figure 5-22 (taken directly from NUREG-1150) illustrates the uncertainty range associated with the predicted total latent cancer fatalities per

reactor year. For Surry, for example, the 5 to 95 percent confidence interval is seen to span approximately two orders of magnitude, i.e., from about $3E-4$ to about $2E-2$ latent cancer fatalities per year. Comparable ranges of uncertainty are found for the other units considered. Containment leakage, at an assumed rate of 1 percent per day, contributes about 0.05 percent to the total risk at Surry; comparable or even smaller contributions were found for the other units. Since the design basis leakage rate for Surry is 0.1 percent per day, the reference risk results already include an order of magnitude "allowance" for increased leakage rate; comparable increases above the design basis leakage rates were incorporated into the assessments for the other units.

Since containment leakage is such a small contributor to overall accident risk, it is clear that at the lower end of the leakage rate ranges considered in this study, any uncertainties associated with the calculated leakage contribution are minuscule in comparison with other uncertainties and therefore uncertainties associated with containment leakage are insignificant.

The NUREG-1150 results for PWRs predict significant probabilities of no containment failure even in the event of core melt accidents. With

the containments predicted to remain intact, at the upper end of the leakage rate ranges considered (i.e., 200 - 400 percent per day), containment leakage could lead to several-fold increases in the predicted risk. Since the expected fission product source terms associated with the large leakage cases were substantially lower than those resulting from containment failure or bypass, the uncertainties associated with assessing the leakage contribution at the upper ends of the ranges considered would be lower than those associated with other containment failure modes.

For BWRs, the calculated risks were found to be very insensitive to the assumed containment leakage rates, even at the upper end of the ranges considered. This is a direct consequence of predicted high probabilities of early containment failure for the BWRs, i.e., since containments are predicted to fail a large fraction of the time, the assumed containment leakage rate is not significant. Also, the scrubbing of the fission products by suppression pools even in many scenarios involving large leakages contributes to the observed lack of risk sensitivity to containment leakage rate. Thus, for BWRs, the uncertainties associated with assessing the contribution of containment leakage are small compared with other uncertainties in the quantification of accident risks.

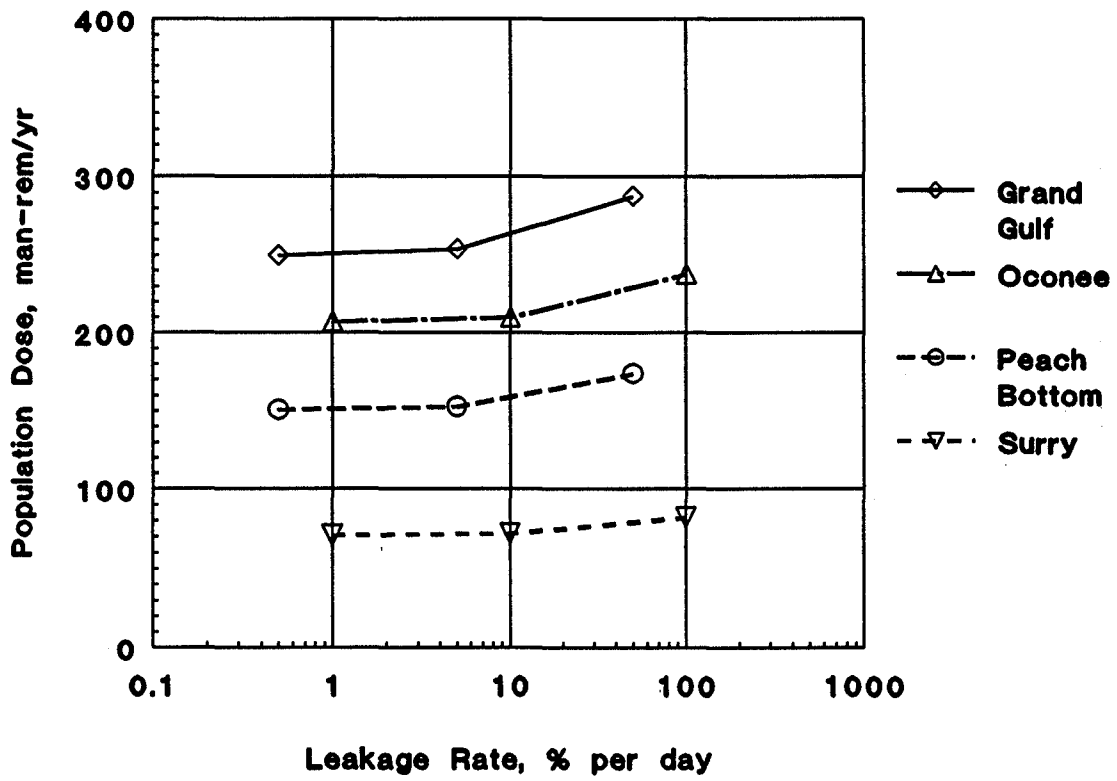

Figure 5-1. Sensitivity of Risk to Containment Leakage Rate

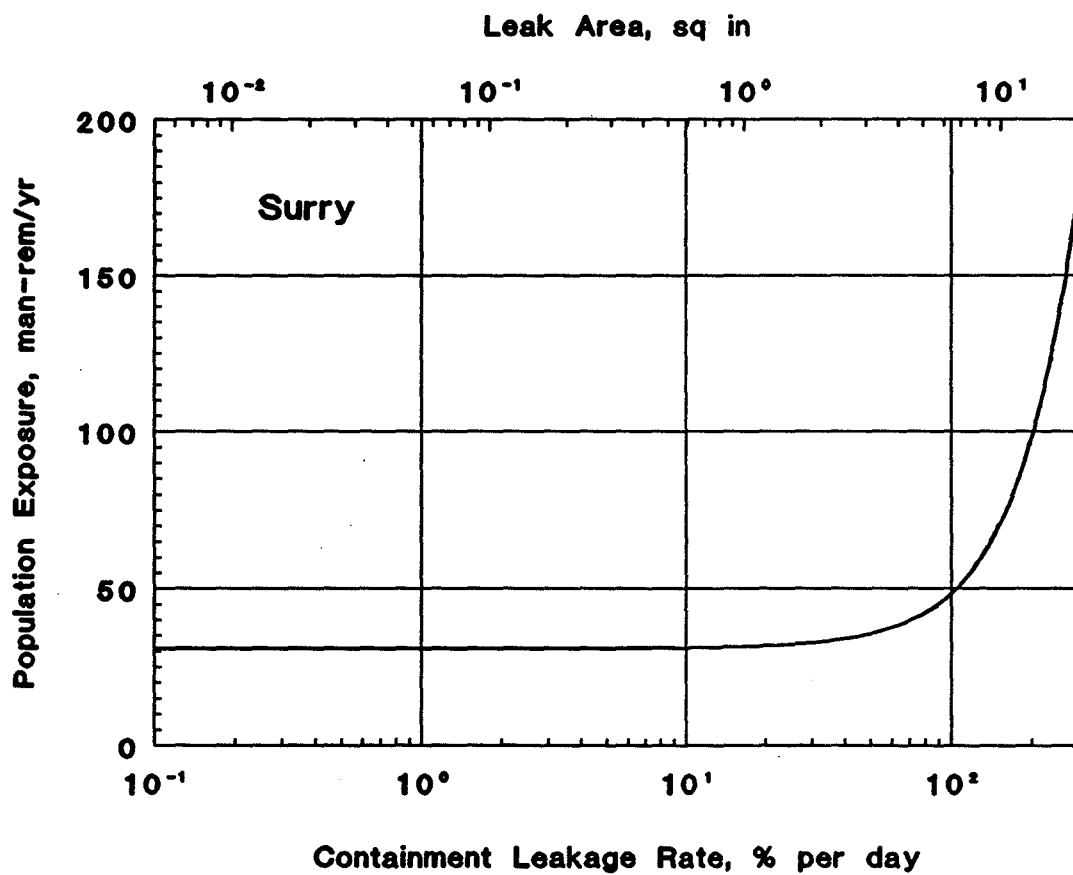

Figure 5-2. Population Exposure as Function of Containment Leakage Rate for Surry

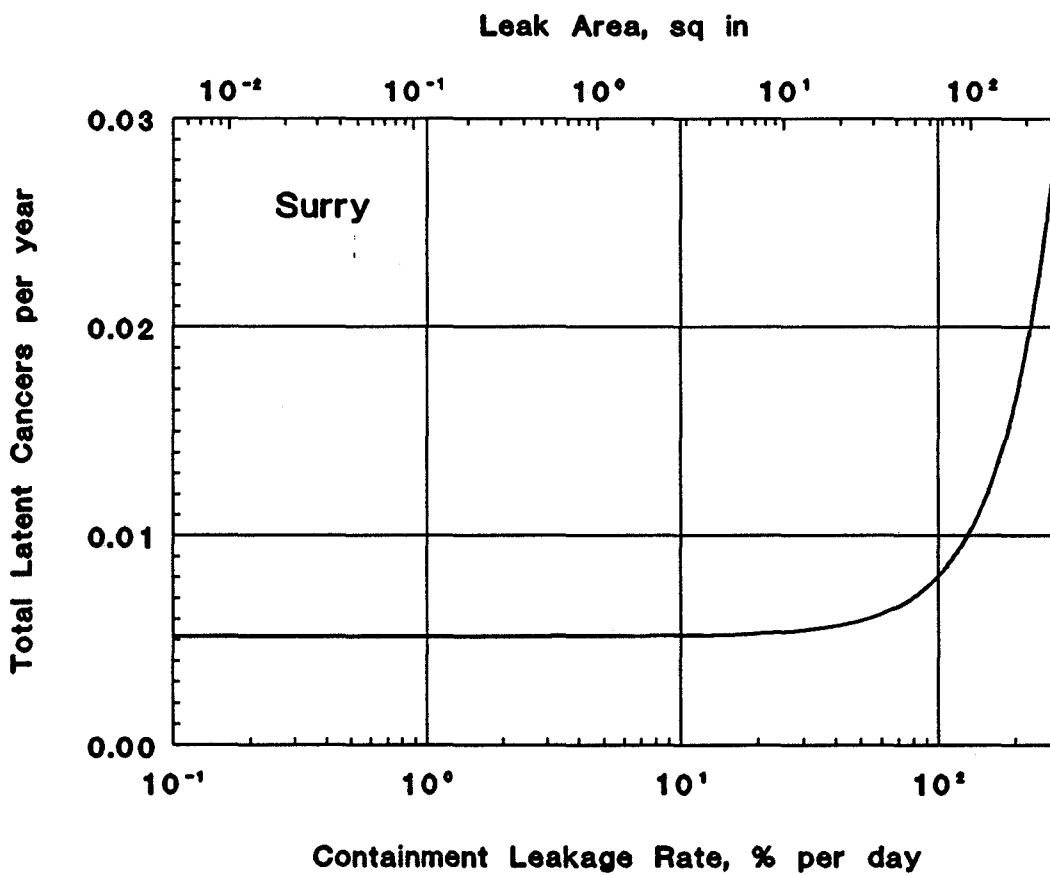

Figure 5-3. Total Latent Cancer Risk as Function of Containment Leakage Rate for Surry

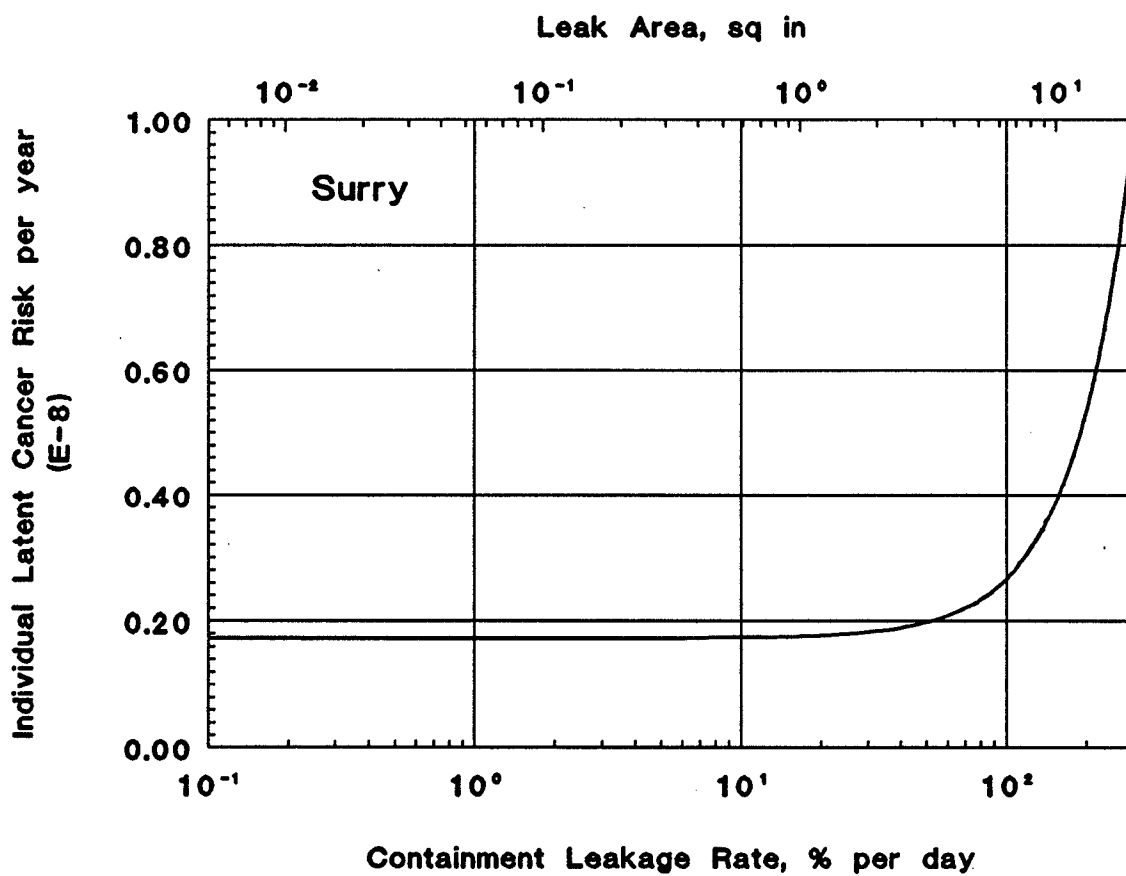

Figure 5-4. Individual Latent Cancer Risk as Function of Containment Leakage Rate for Surry

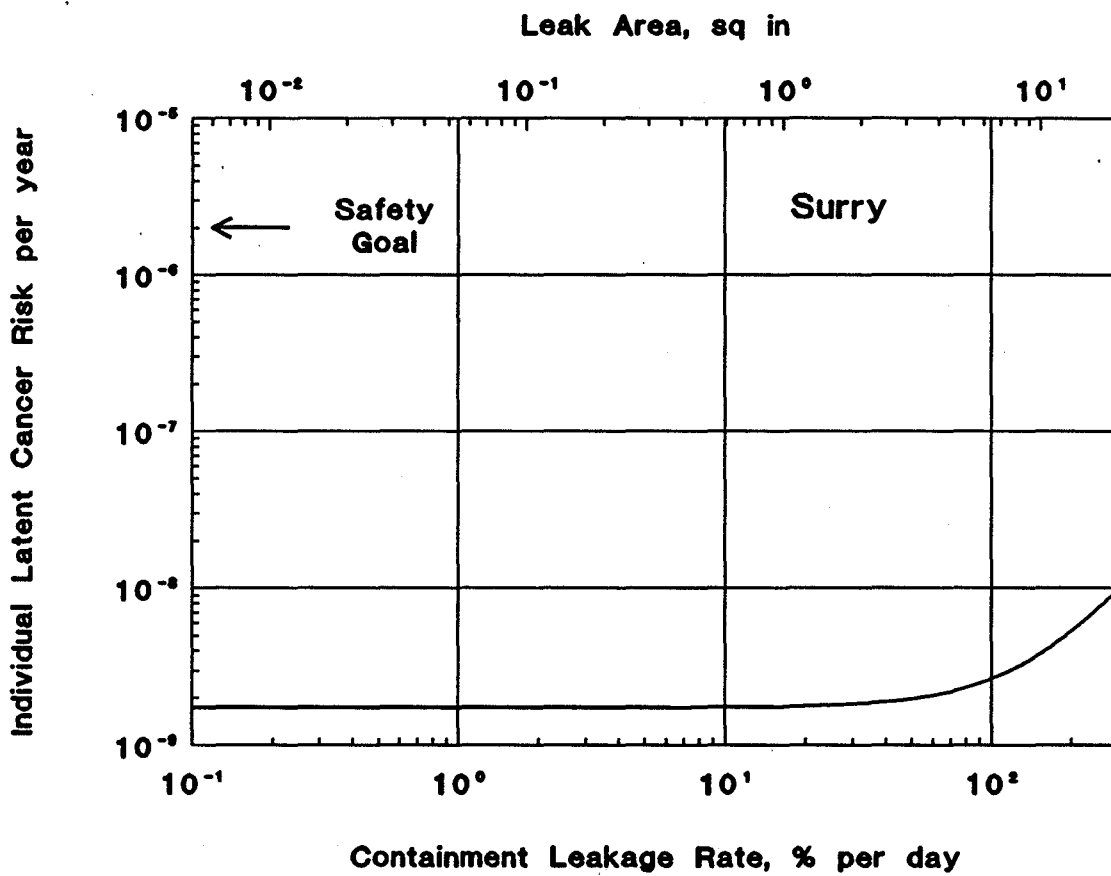

Figure 5-5. Comparison of Individual Latent Cancer Risk for Surry with NRC Safety Goal

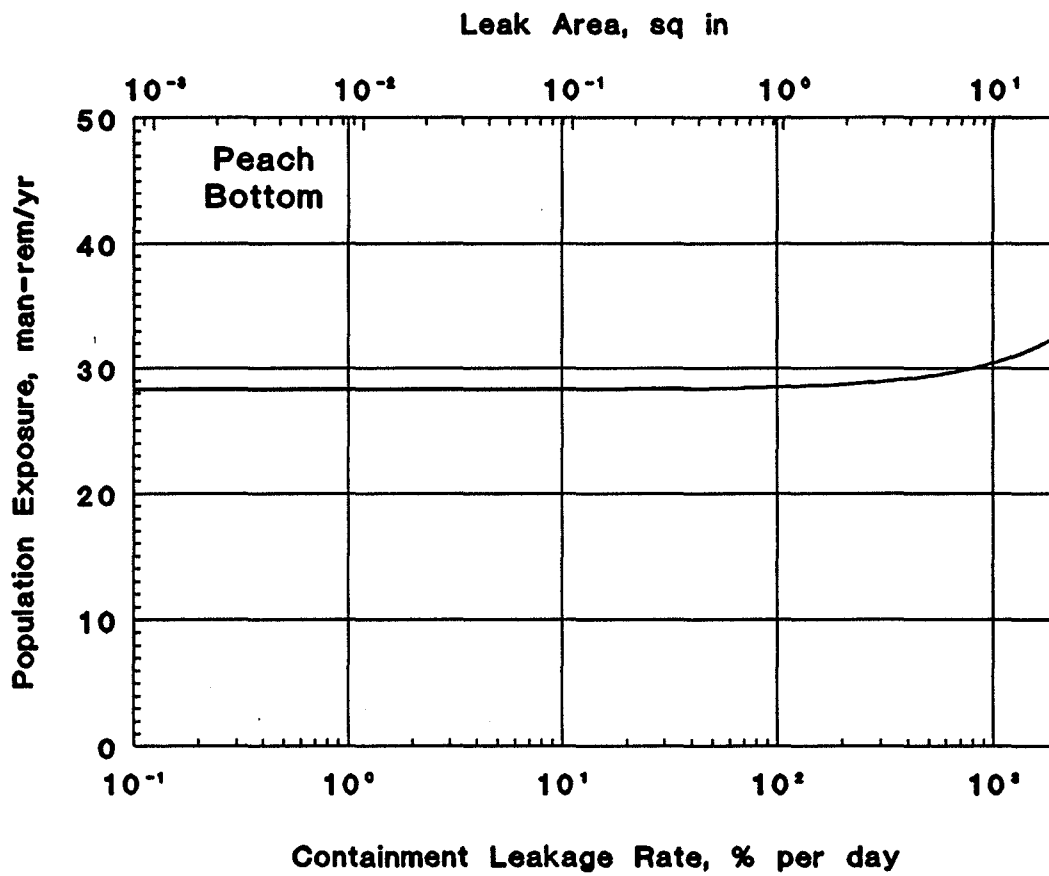

Figure 5-6. Population Exposure as Function of Containment Leakage Rate for Peach Bottom

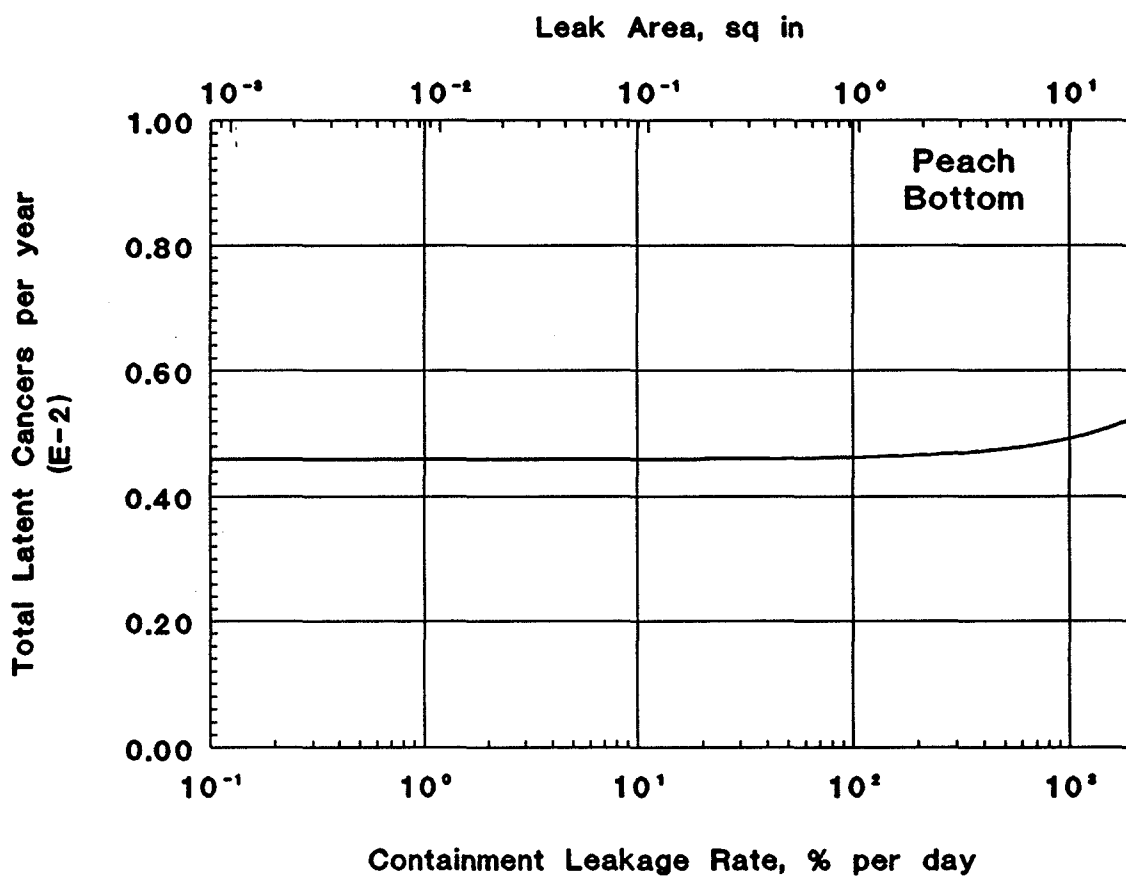

Figure 5-7. Total Latent Cancer Risk as Function of Containment Leakage Rate for Peach Bottom

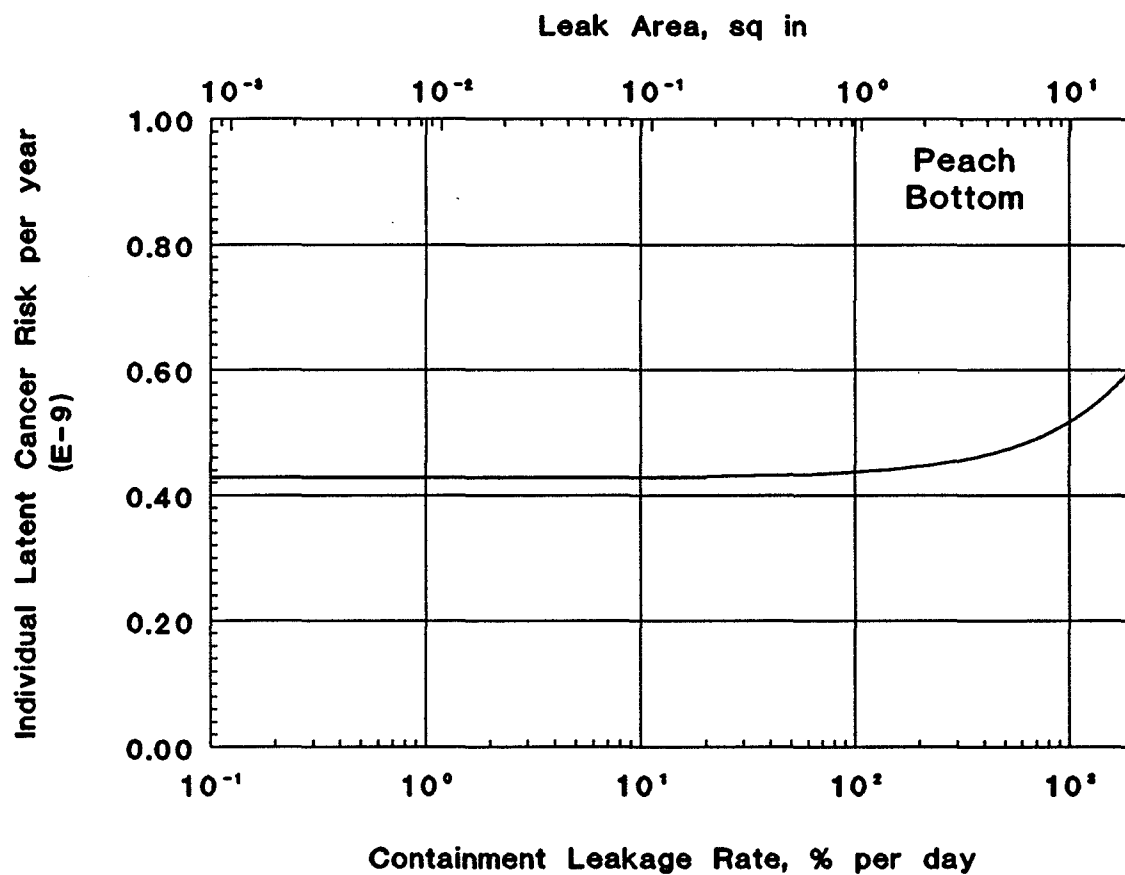

Figure 5-8. Individual Latent Cancer Risk as Function of Containment Leakage Rate for Peach Bottom

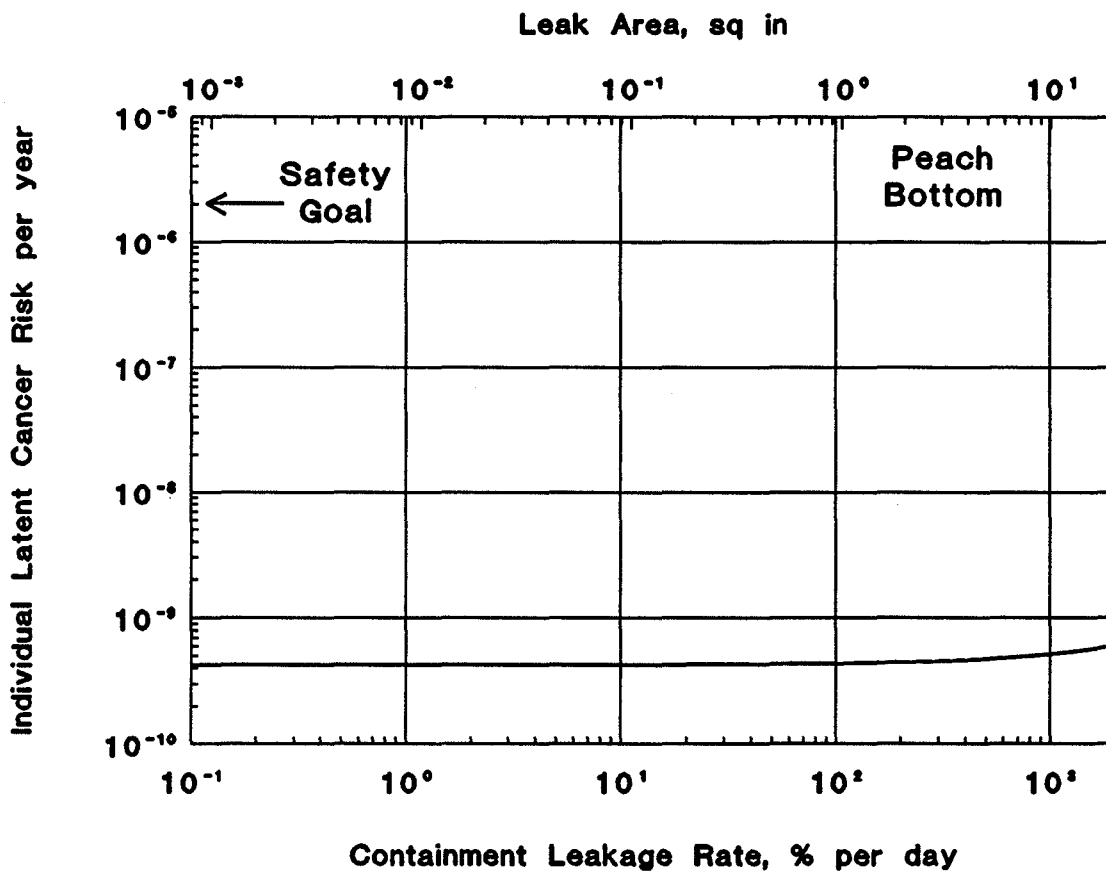

Figure 5-9. Comparison of Individual Latent Cancer Risk for Peach Bottom with NRC Safety Goal

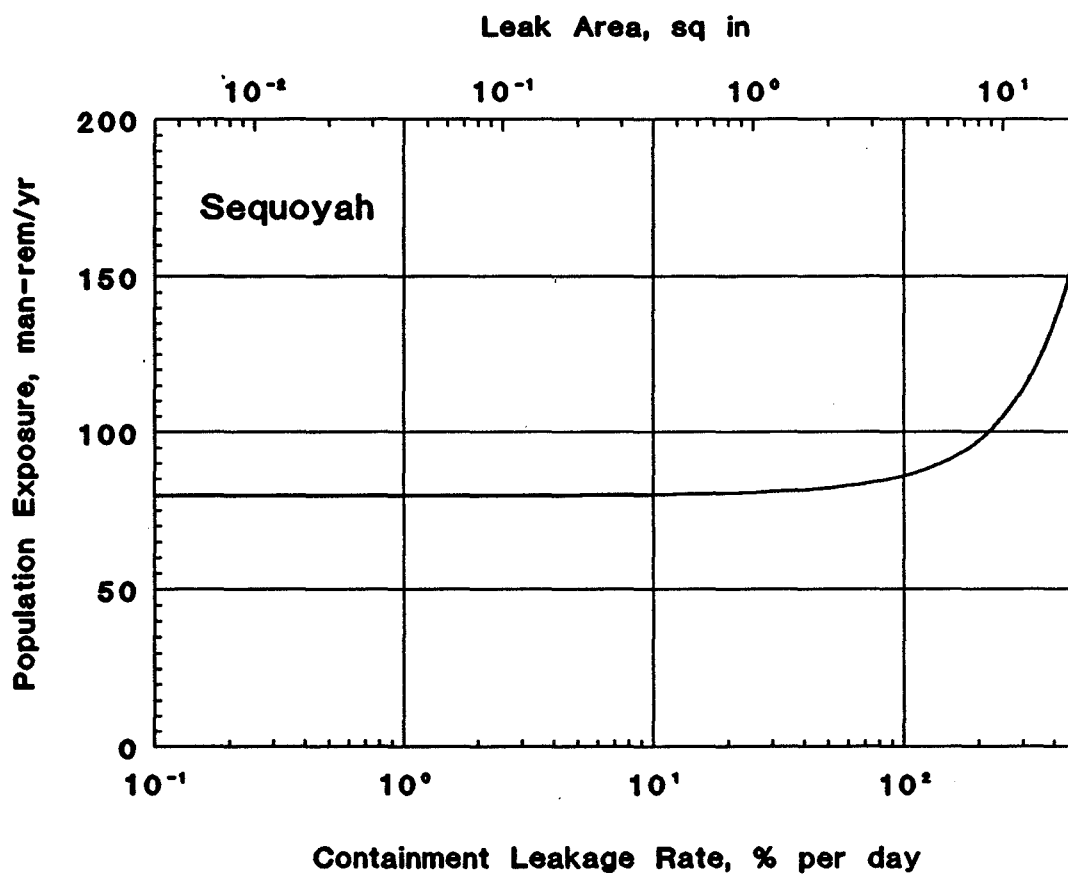

Figure 5-10. Population Exposure as Function of Containment Leakage Rate for Sequoyah

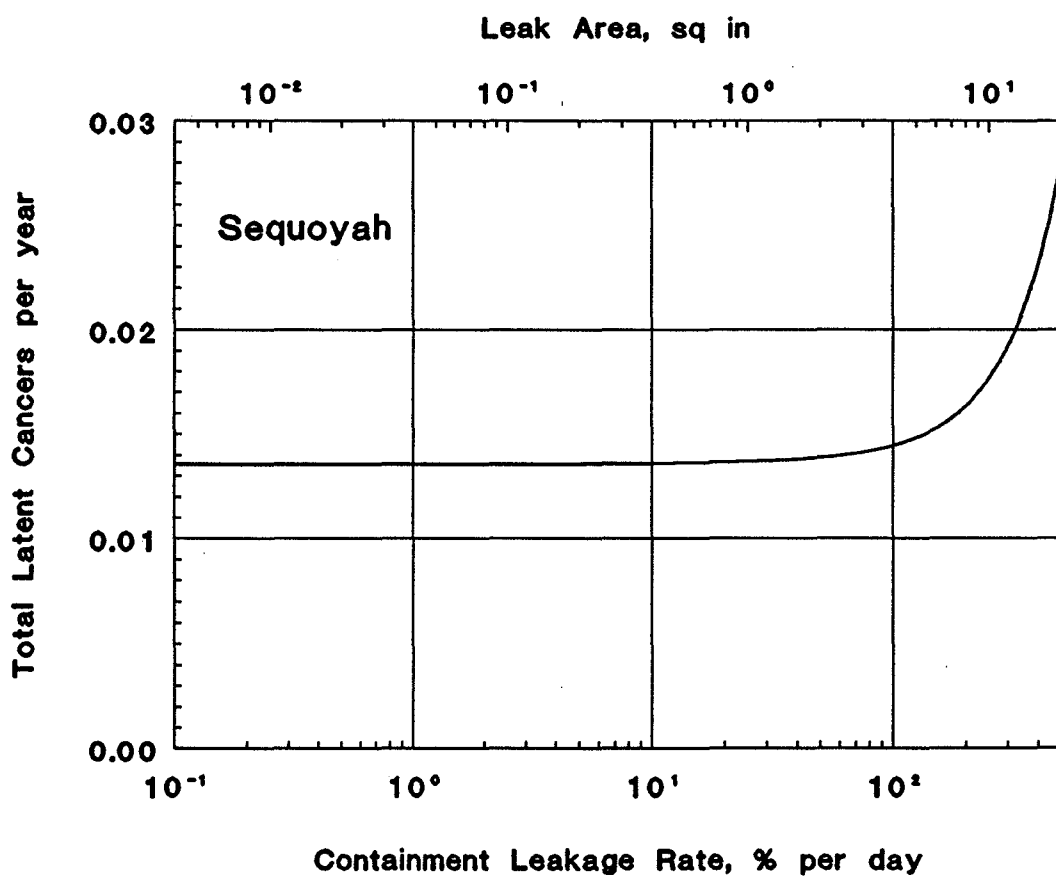

Figure 5-11. Total Latent Cancer Risk as Function of Containment Leakage Rate for Sequoyah

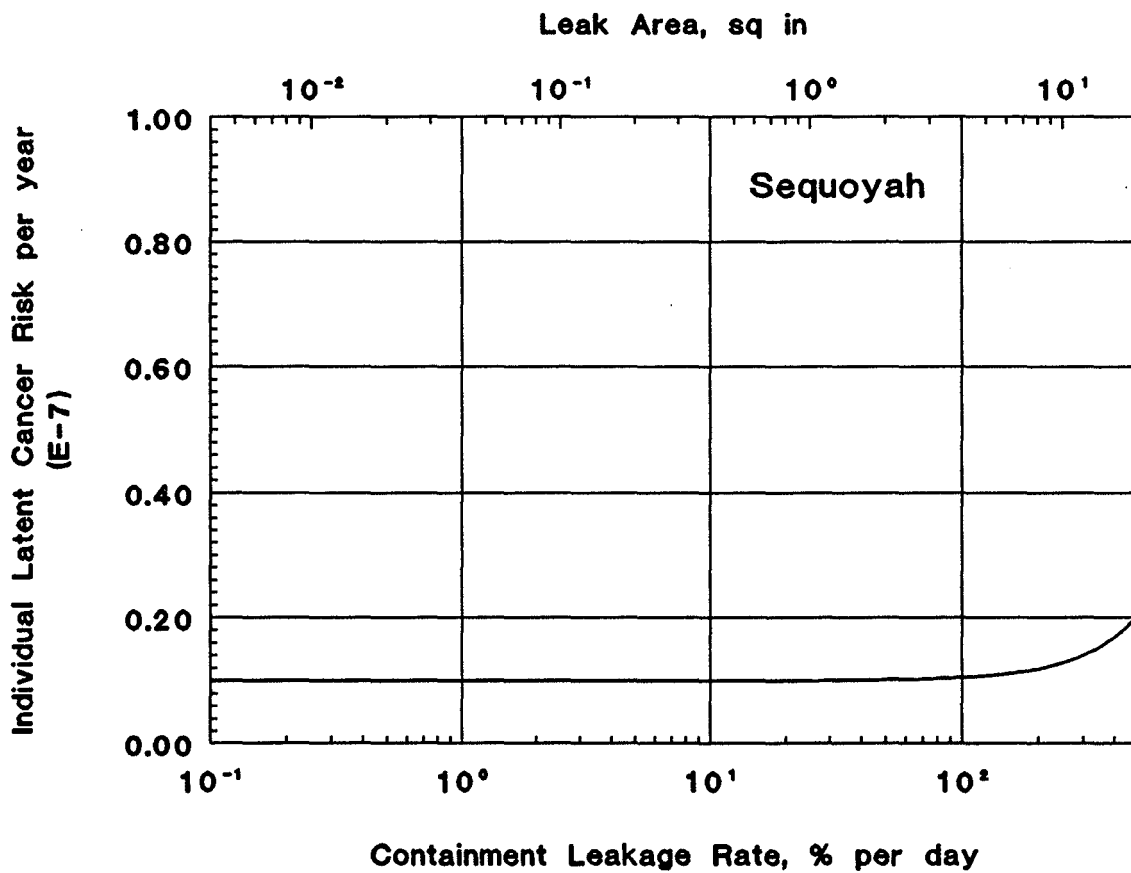

Figure 5-12. Individual Latent Cancer Risk as Function of Containment Leakage Rate for Sequoyah

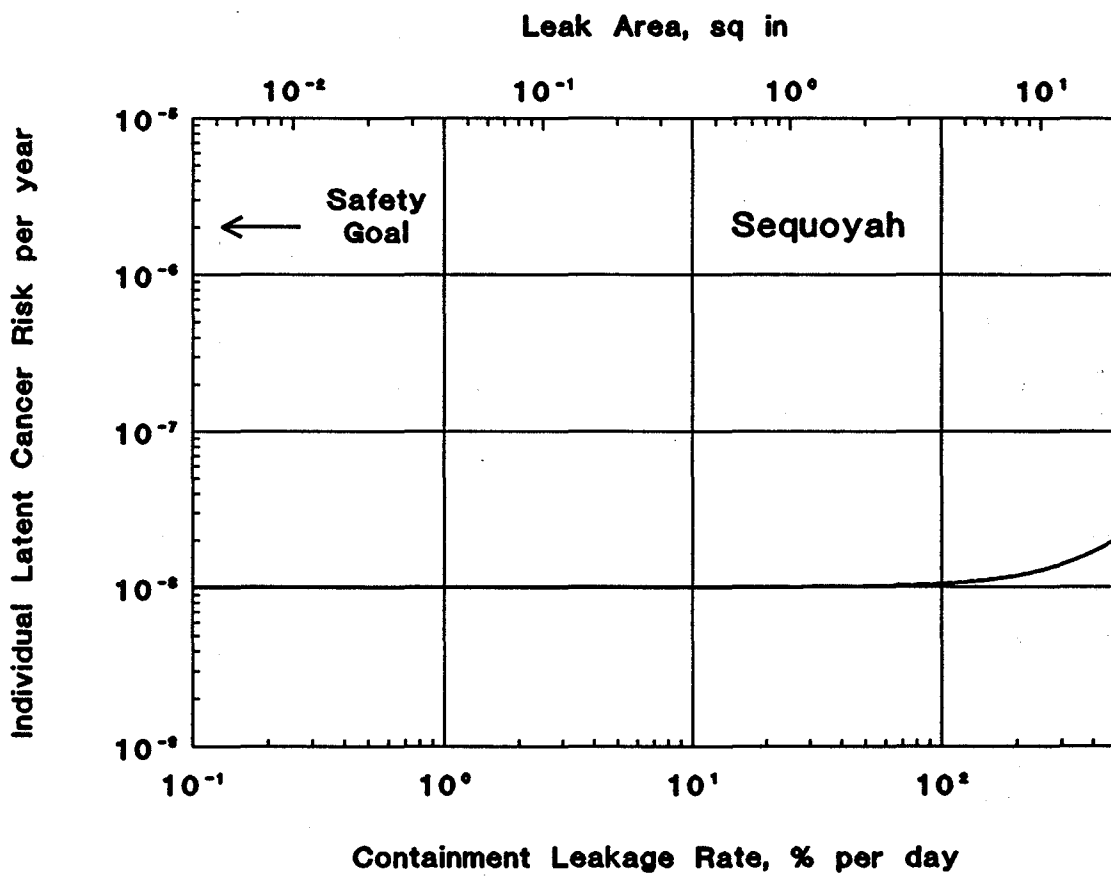

Figure 5-13. Comparison of Individual Latent Cancer Risk for Sequoyah with NRC Safety Goal

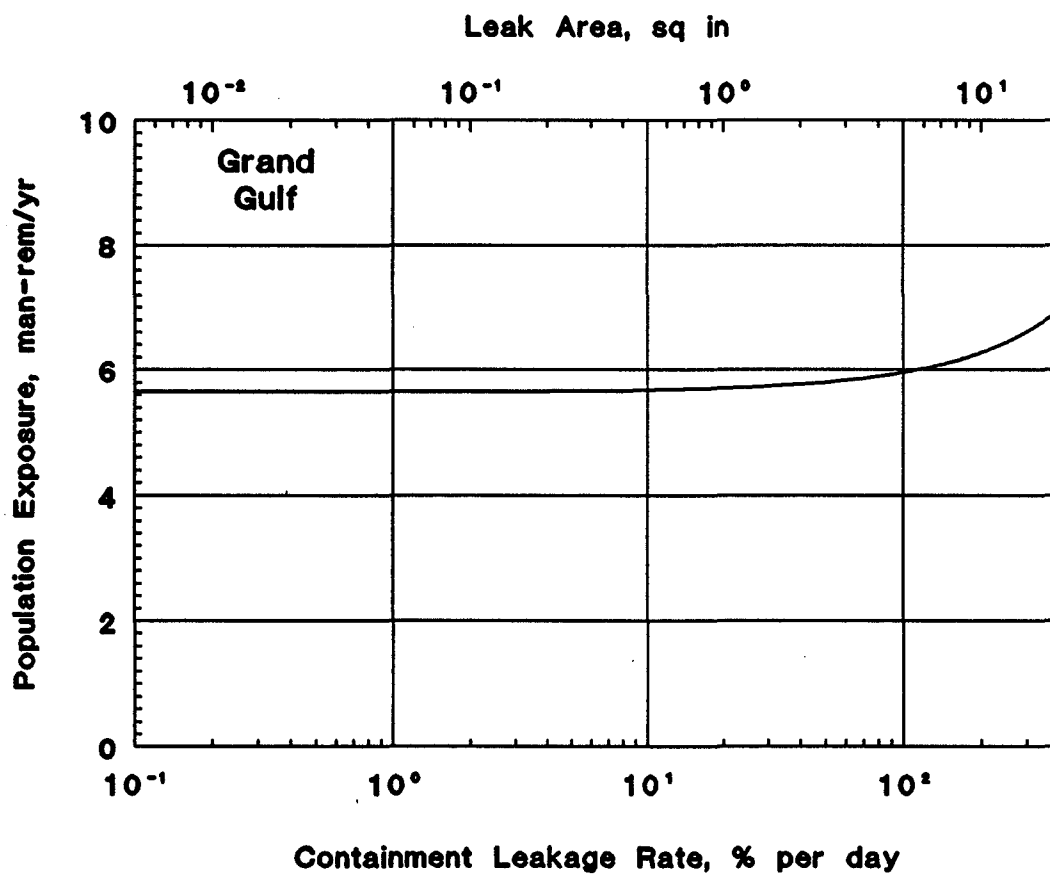

Figure 5-14. Population Exposure as Function of Containment Leakage Rate for Grand Gulf

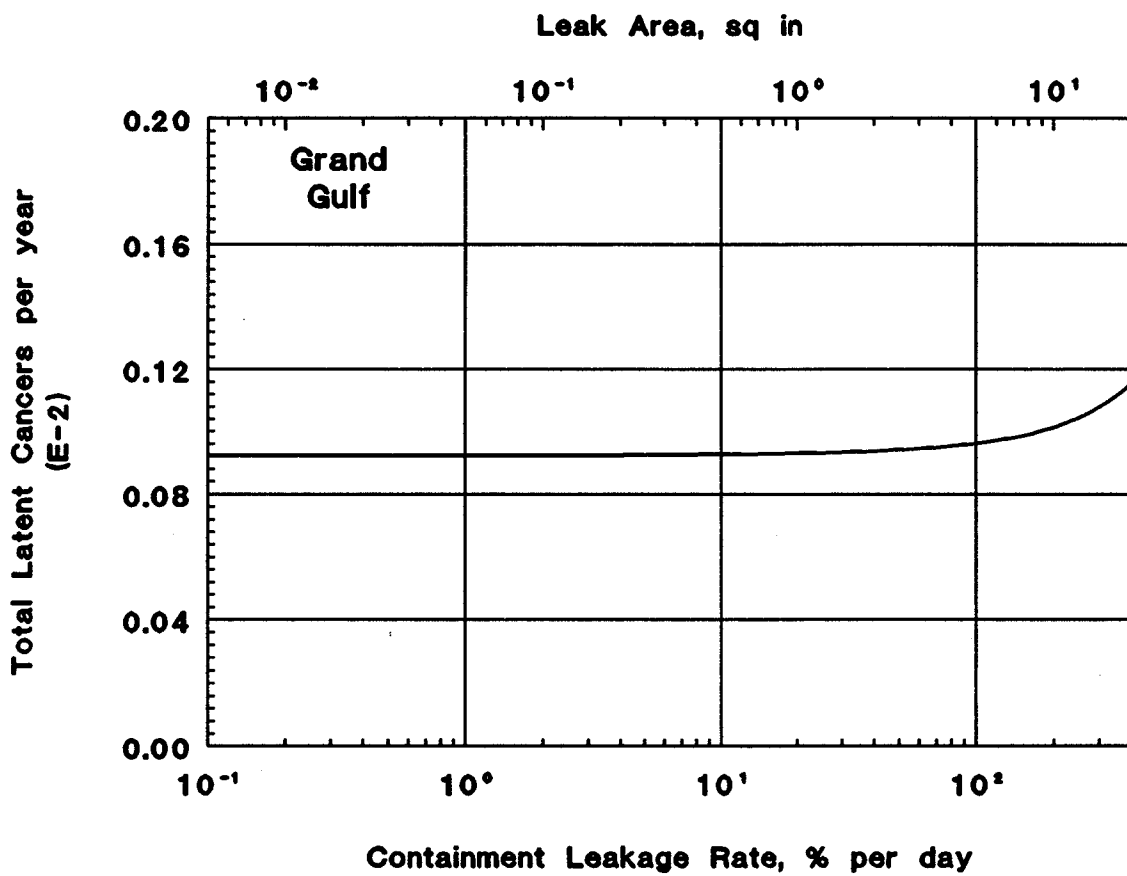

Figure 5-15. Total Latent Cancer Risk as Function of Containment Leakage Rate for Grand Gulf

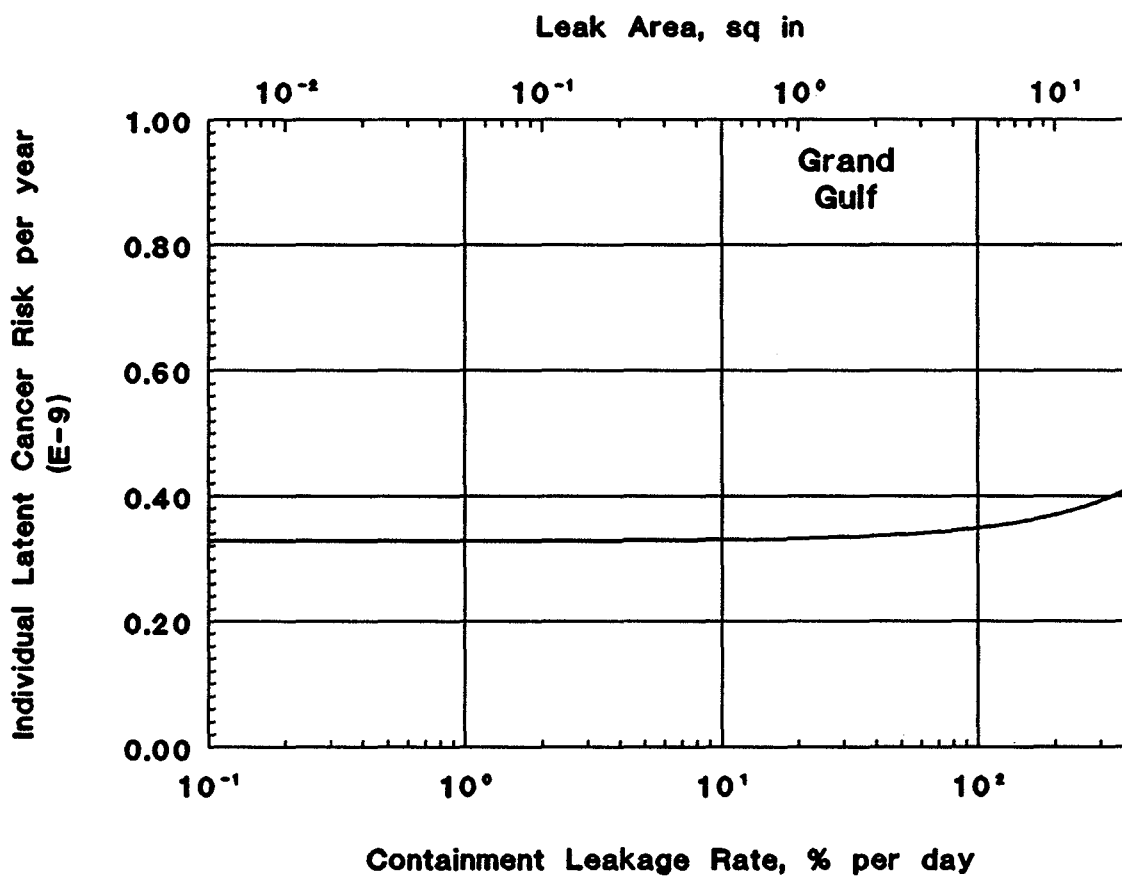

Figure 5-16. Individual Latent Cancer Risk as Function of Containment Leakage Rate for Grand Gulf

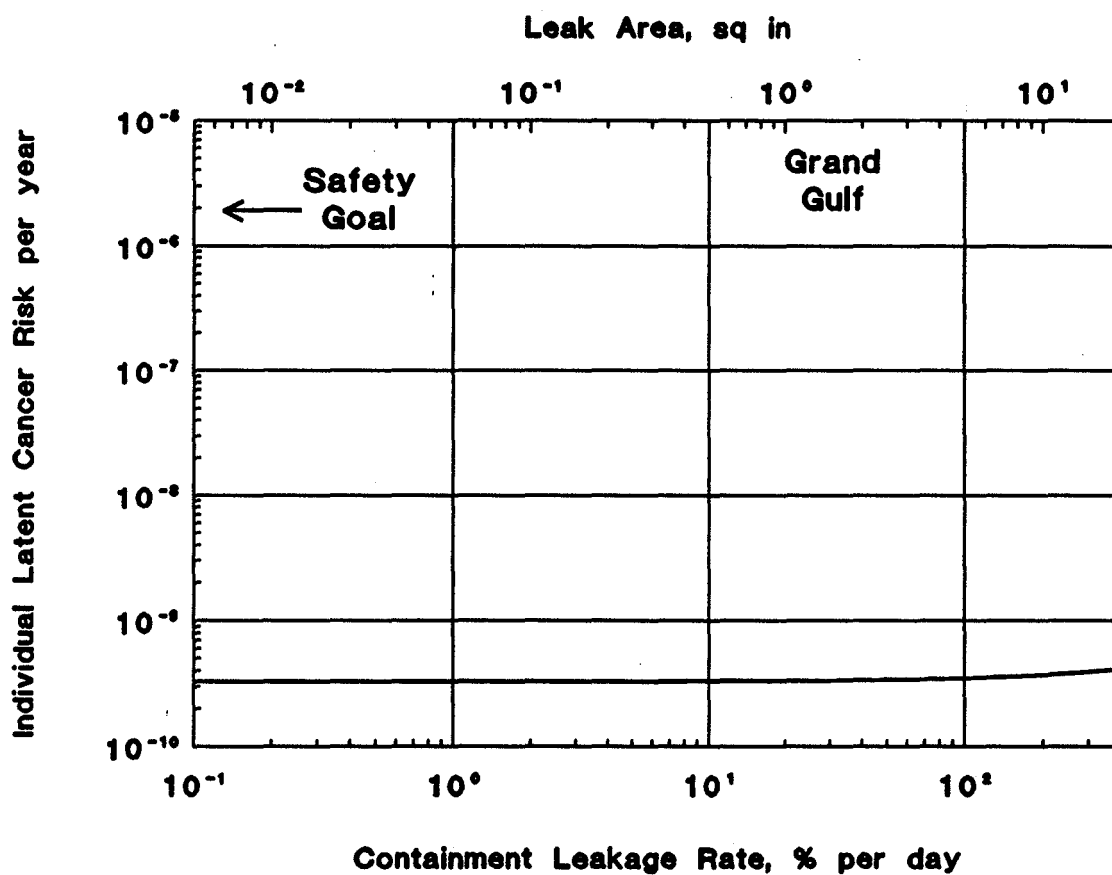

Figure 5-17. Comparison of Individual Latent Cancer Risk for Grand Gulf with NRC Safety Goal

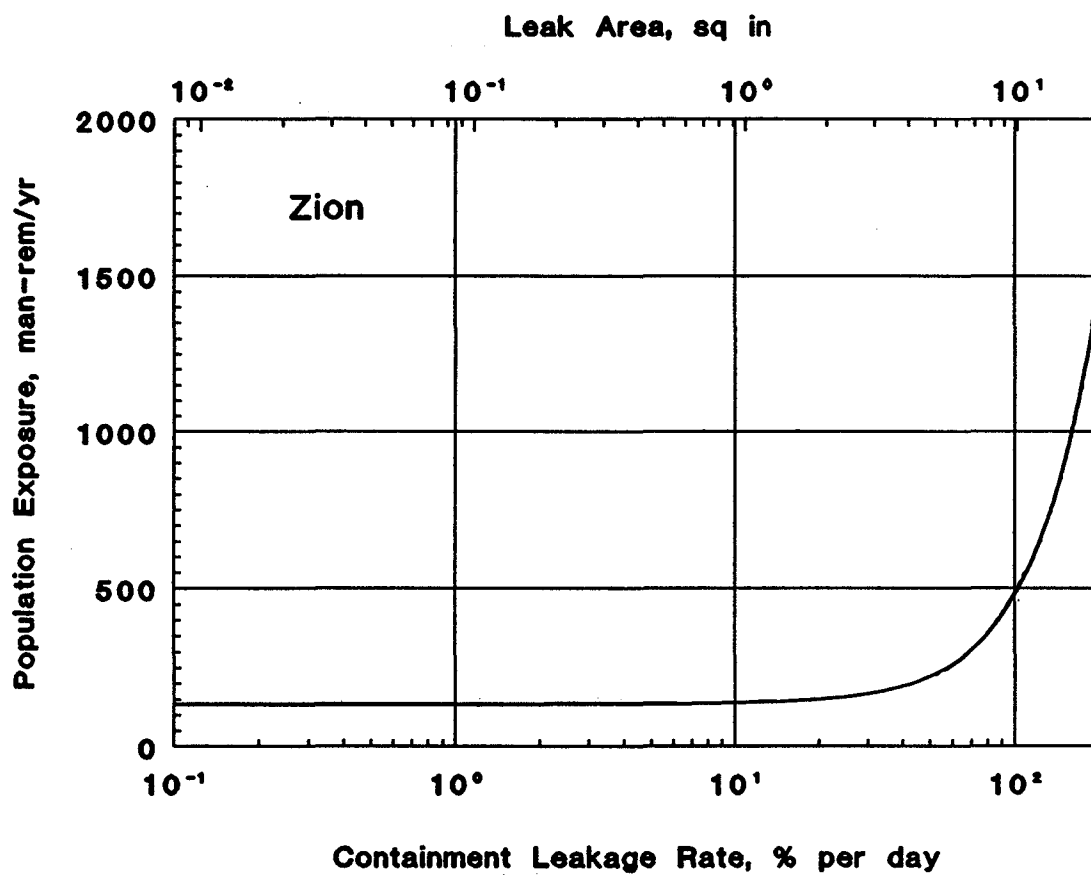

Figure 5-18. Population Exposure as Function of Containment Leakage Rate for Zion

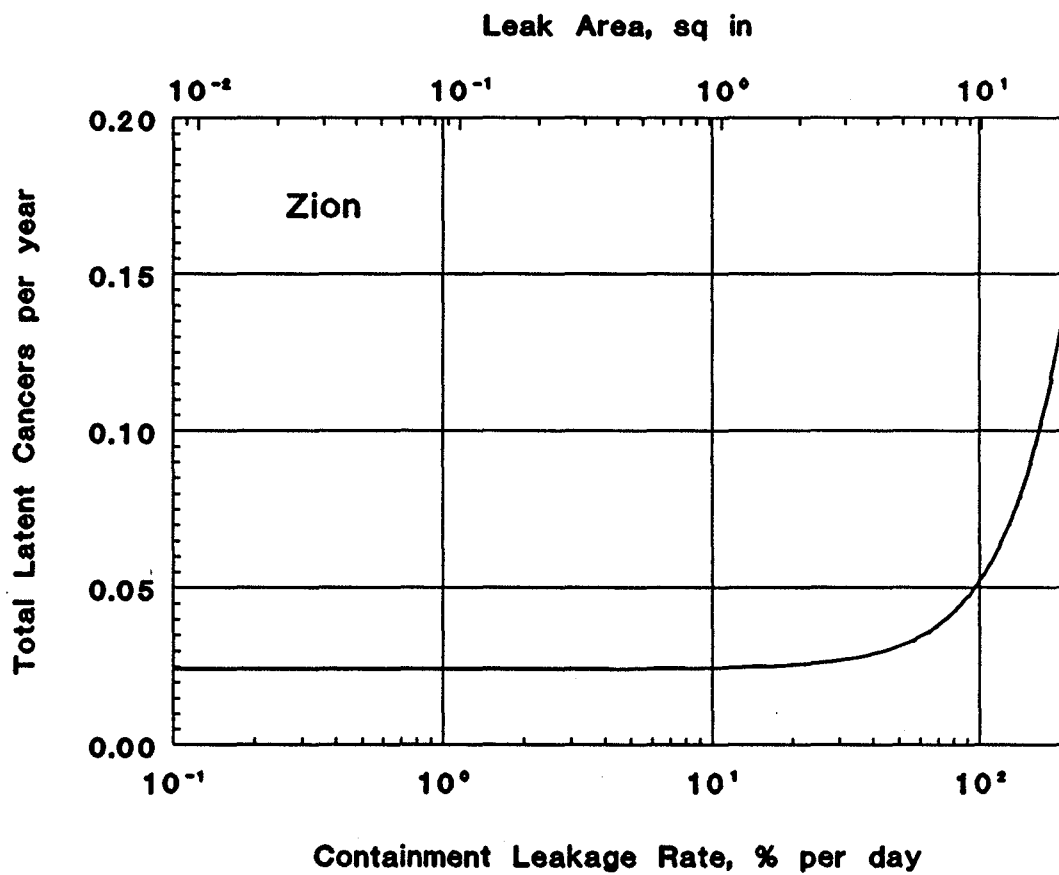

Figure 5-19. Total Latent Cancer Risk as Function of Containment Leakage Rate for Zion

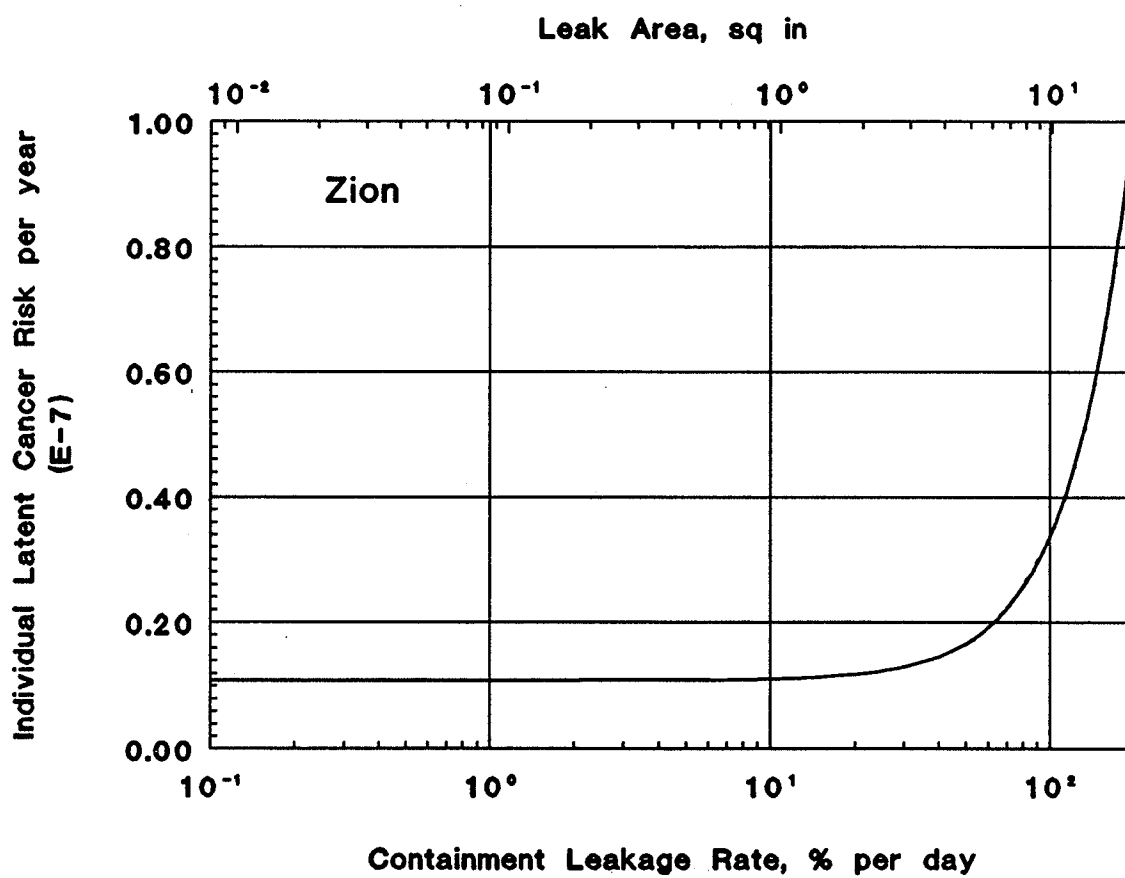

Figure 5-20. Individual Latent Cancer Risk as Function of Containment Leakage Rate for Zion

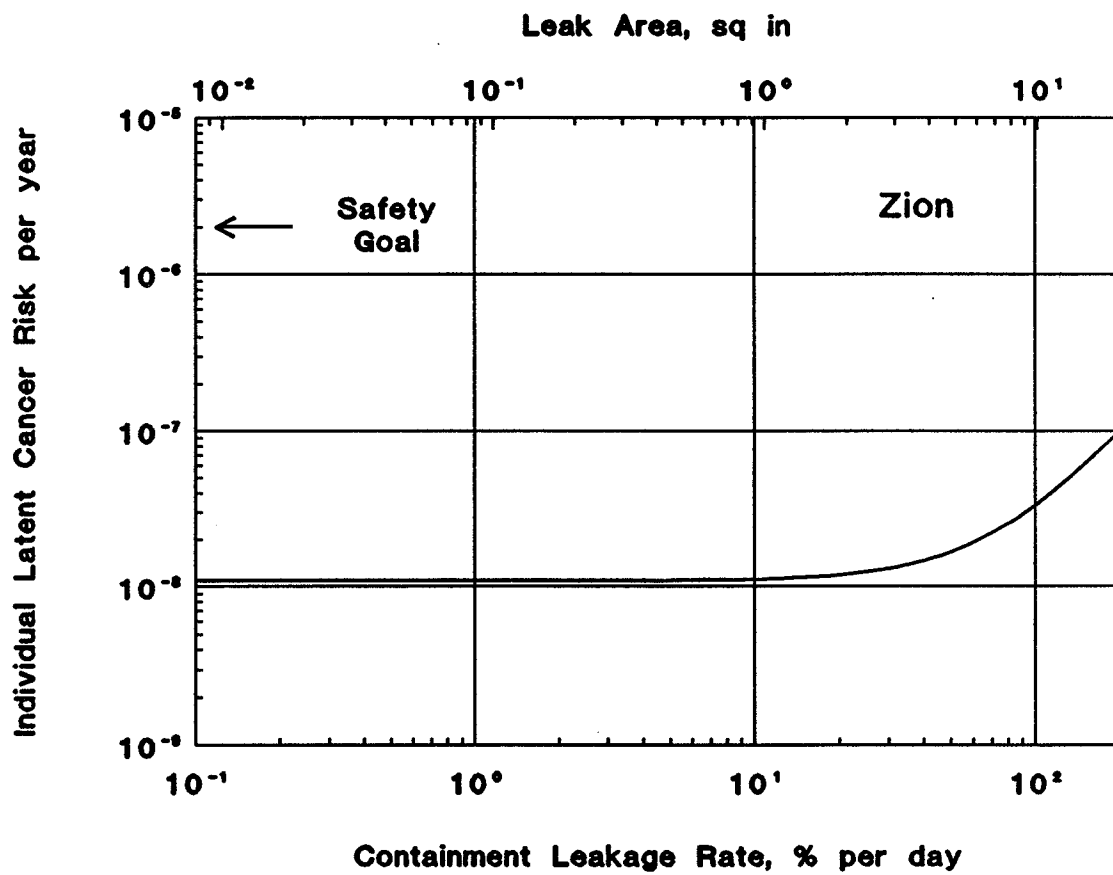

Figure 5-21. Comparison of Individual Latent Cancer Risk for Zion with NRC Safety Goal

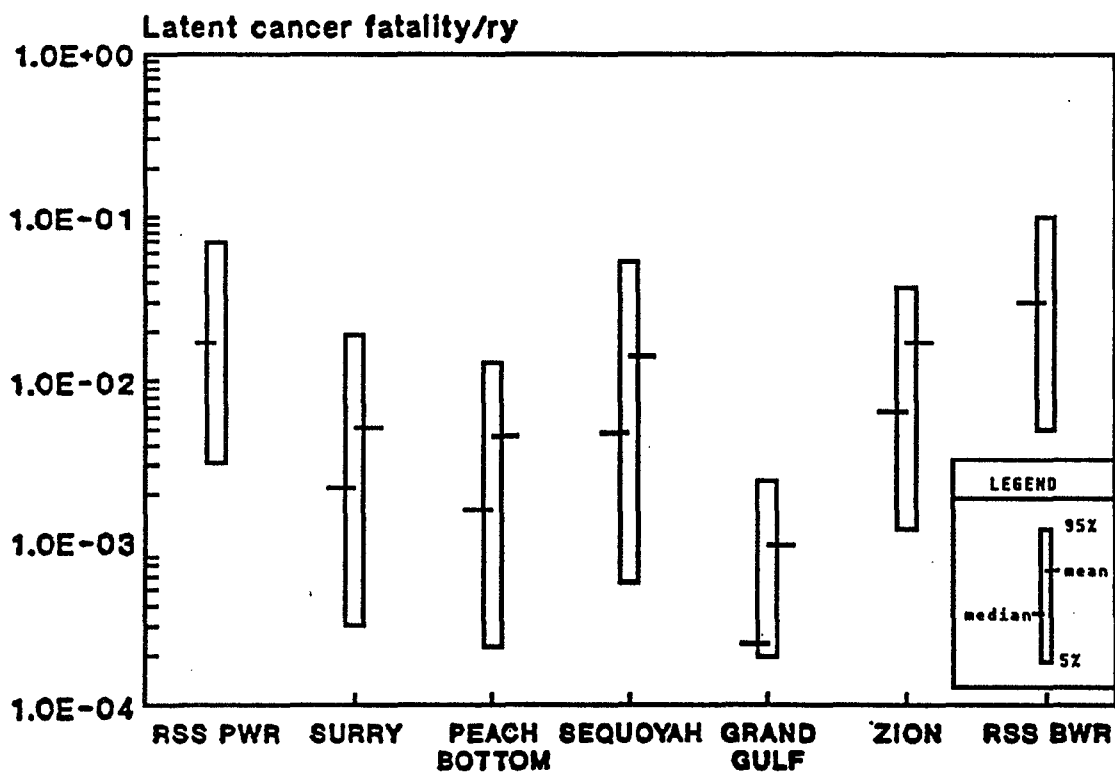
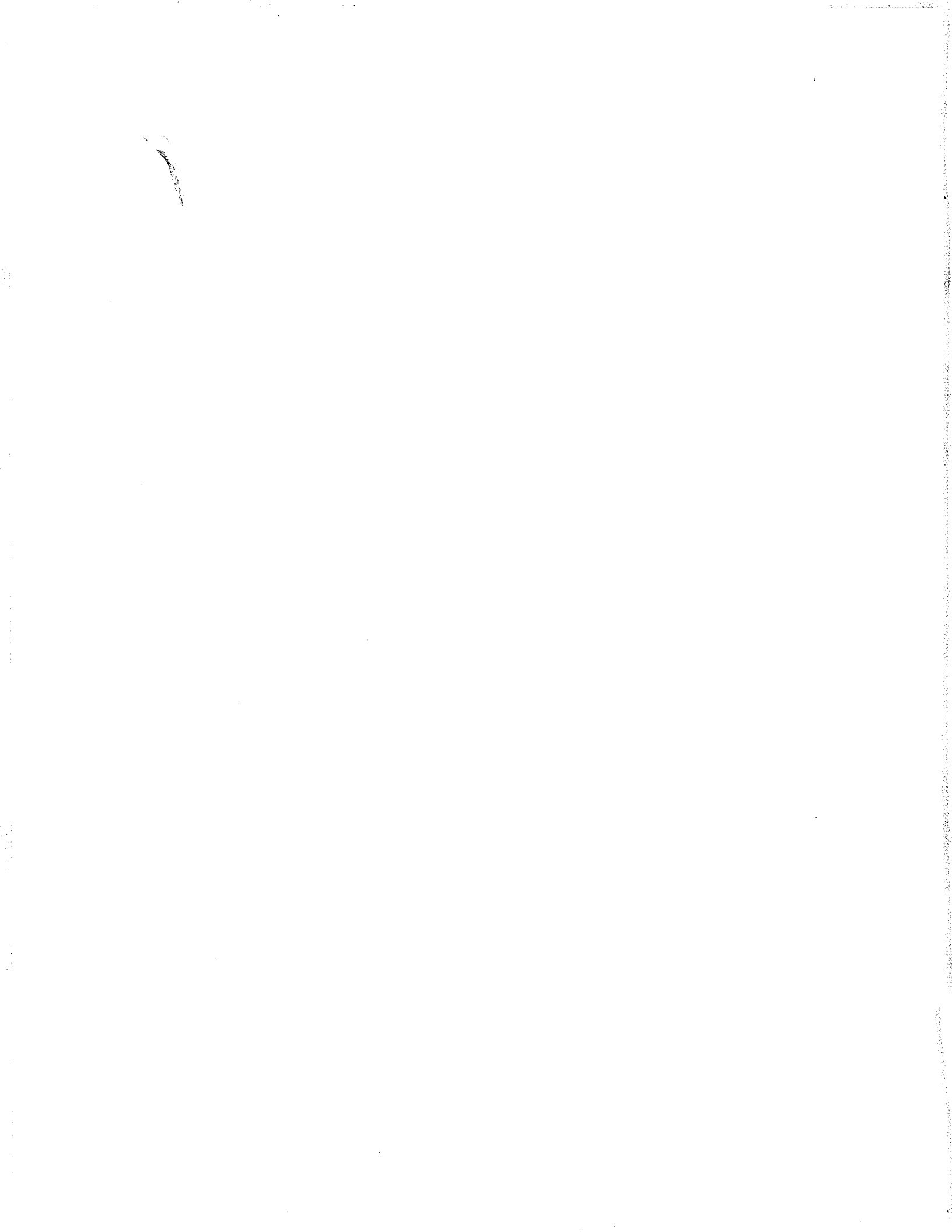

Figure 5-22. Uncertainties Associated with Latent Cancer Risks in NUREG-1150 and WASH-1400



6. Alternatives

The NRC considers the existing 10 *CFR* Part 50, Appendix J to be a prescriptive regulation. Prescriptive regulations are written with a high degree of specificity, leaving proportionately less flexibility and discretion to the licensee. To eliminate requirements that are marginal to safety, the NRC is adopting a performance-based approach to developing regulatory requirements. Performance-based regulations will include goals and limits based upon the operating history of equipment and components, i.e., an inherently more risk-based approach. Performance-based regulations also afford more flexibility and discretion to licensees, especially those whose performance is superior.

In adopting a performance-based regulatory approach, the NRC has adopted the following criteria to guide its decision-making:

- Performance-based regulation allows the licensee flexibility to adopt cost-effective methods for implementing the regulatory/safety goals of the original rule. Regulatory/safety objectives should be established in as objective a manner as practical.
- The regulatory/safety objectives are derived, to the extent feasible, from risk considerations and their relationship to the NRC's safety goals.
- Detailed technical methods for measuring or judging the acceptability of a licensee's performance in achieving the regulatory/safety objectives are, to the extent practicable, provided in industry standards and guidance documents which could be endorsed in the NRC's regulatory guides.
- The new regulation is optional for current licensees so that licensees can decide to remain in compliance with current regulations.
- The regulation is supported by necessary modifications to or development of the full

body of regulatory practice including, for example: standard review plans, inspection procedures, regulatory guides, and other regulatory documents.

- The new regulation is formulated to provide incentives for innovations leading to improvements in safety through better design, construction, operating, and maintenance practices.

As demonstrated in Chapter 5, the insensitivity of calculated reactor accident risks to containment leakage rate suggests existing leak-tightness requirements could be relaxed without significantly affecting potential impacts on the health and safety of the public. The present study identifies alternatives to the existing containment leakage-testing requirements including: (1) relaxation of the allowable leakage rates, (2) reduction in the frequency of leakage-rate testing, and (3) use of on-line monitoring systems. Additionally, Entergy Operations, Inc., the operator of the Grand Gulf Nuclear Station (GGNS), has applied for an exemption from Appendix J requirements and has proposed an alternative testing program.

6.1 INTEGRATED LEAKAGE-RATE (TYPE A) TESTS

Of the Appendix J test methods, integrated leakage-rate testing is the only method capable of detecting all existing leaks in the reactor containment system. However, Type A testing can be performed only during shutdowns, precluding other activities while such testing is in progress. For these reasons, integrated leakage-rate testing is performed infrequently. Further, as discussed in Chapter 4, local leakage-rate tests (LLRTs) can find a very high percentage of leaks in containment.

Alternatives to current integrated leakage-rate testing that have been considered include relaxation in allowable leakage rates as well as a decrease in the frequency of such tests.

Alternatives

Regulatory/Safety Objective

To allow the licensees more flexibility in the allocation of resources while maintaining a high degree of assurance of containment integrity. Risk impact, as measured by expected population exposure derived from probabilistic risk assessments, is the yardstick by which various alternatives are measured.

As discussed in Chapter 5, past and current probabilistic risk assessments demonstrate that population risk is quite insensitive to containment leakage rate. The risk assessment for the Surry unit assumes a leakage rate 10 times higher than the design level. Even with a conservative leakage rate, the incremental risk due to containment leakage is only about 0.05 percent of the total. Considering the NRC's safety goals, the individual latent fatality risk for Surry is assessed to be about three orders of magnitude below the goal. Even for assumed containment leakage rates of several hundred percent per day, the calculated increase in risk is still orders of magnitude below the goal. Comparable results are found for the other units considered in this study. Also, the incremental contribution of containment leakage is well within the overall uncertainty bounds of the risk assessments for a very broad range of assumed containment leakage rates.

Leakage Rate

As indicated in the discussion of leakage-rate test experience in Chapter 4, the leakage rates observed in a significant fraction of "failed" leakage-rate tests are only marginally above the specifications. Thus, a relaxation of leak-tightness requirements would reduce the number of failed tests and minimize the potential need for retesting. Relaxation of leak-tightness requirements could also facilitate shorter test periods, thus permitting more of the tests to be conducted at a fraction of the nominal 24-hour

duration. A range of modified leak-tightness requirements was considered.

Frequency

As noted in Chapter 2, current regulations require the performance of three integrated containment leakage-rate tests over a 10-year interval. If a facility has poor experience with these tests, the frequency could conceivably be increased to every shutdown for refueling. In practice and with proper justification, the NRC permits increased LLRTs in lieu of increased ILRTs. Due to the insensitivity of reactor accident risk to leakage rate, and because under current practice only a small fraction of excessive leakages is being detected by integrated leakage-rate testing, it is appropriate to consider alternatives extending the interval between such tests. Accordingly, testing intervals of two times in 10 years, one in 10 years, and one in 20 years were identified for analysis.

GGNS is proposing to establish a 10-year interval for Type A testing. GGNS has performed a preservice Type A test and two periodic Type A tests. The first periodic type A test was unacceptable due to four Type C penetration leakages for which corrective action has been implemented. The other two Type A tests were successful.

Potential Issues

Under current regulations, reactor siting is dependent upon the containment leak-tightness specifications. Thus, relaxation in leak-tightness requirements would require analysis to assess compatibility with the siting requirements in 10 CFR Part 100.

6.2 LOCAL LEAKAGE-RATE (TYPE B & C) TESTS

As with the ILRT, possible alternatives to current Type B and C tests include relaxation

in allowable leakage rates as well as a decrease in frequency of testing.

Regulatory/Safety Objective

Same as stated for Type A tests.

Leakage Rate

Under current practice, local leakage-rate testing is performed on all containment penetrations and containment isolation valves during each refueling shutdown. Any significant leakages that are detected are repaired (either because a regulatory limit may be exceeded or because of good practice), even if they do not greatly affect the overall containment minimum path leakage rate. Thus, while the number of repairs performed to correct component leakage might decrease slightly, it is not clear that any significant benefit would be derived from a relaxation of total allowable leakage rate as applied to local leakage-rate testing.

Frequency

Under current requirements, local leakage-rate testing is conducted at every refueling shutdown, but no longer than at 2-year intervals. Under current practice, testing is performed prior to the integrated containment leakage-rate test, and any local leakages that are found are repaired before the integrated test. The leakage reductions from any such repairs are added to the actual leakage measured during the integrated test to determine the "as-found" containment leakage rate. Historically, local leakage-rate testing is conducted simultaneously with other shutdown activities, thus, they have relatively less impact on operations than ILRTs, and the costs associated with the tests are limited to the expense of conducting the test itself. Recent information supplied by NUMARC indicates that system out-of-service-time can affect the outage critical path (NUM94). Consequently, the alternative of decreasing the frequency of local leakage-rate testing has been considered.

A specific proposal for lessening the frequency of local leakage-rate testing has been advanced by the Grand Gulf Nuclear Station. GGNS reports that its Type B & C testing indicates about a 95 percent success rate. GGNS also indicates that most of the observed leakages are limited to selected components that experience repeated failures. Based on this experience, GGNS proposes a revised approach to local leakage-rate testing in which any penetration that successfully passes two successive tests need not be tested until the time of the next 10-year integrated leakage-rate test. Any penetration that fails a test would have to be retested each shutdown until two consecutive successes are observed. Such an approach is an example of a performance-based regulation that offers the promise of reducing the amount of local leakage-rate testing that would be required.

Specifically, GGNS proposes to establish Type B & C test intervals based on the performance history of components.

- Components that are known to have a history of excessive leakage, such as the main steam and feedwater isolation valves, will remain on the current test interval of 2 years.
- The test intervals for the remaining components will be as follows:
 - 2 years for components that have passed only one test or failed the previous test,
 - 5 years for components that have passed 2 consecutive tests,
 - 10 years for components that have passed 3 consecutive tests.

It has also been proposed that statistical sampling techniques be employed in lieu of testing all valves and penetrations during each test. In principle, if enough valves and penetrations in the sample pass the initial

Alternatives

prescribed tests, no further testing would be required until the next scheduled test period. If the sample doesn't pass, a greater sample size would be selected for testing, up to and including all components, until a successful result is obtained. Such an approach is similar to the GGNS proposal discussed above.

Another approach is to limit frequent testing to only those leakage paths that have a potential risk significance. Such an approach eliminates small penetrations from consideration and limits testing to only the larger penetrations. Examination of typical distributions of penetration size versus number suggest that only a small number of penetrations would be excluded by this approach.

Appendix A presents an in-depth evaluation of leakage-rate experience for a two-reactor nuclear power station.

Potential Issues

As discussed in Chapter 4, local leakage-rate testing experience indicates that some isolation valves have exhibited leakage rates greater than the test equipment can quantify. However, the overall leakage rate has generally remained within acceptable limits because penetrations are normally redundant. This lack of quantification of individual leakage paths precludes the development of models that correlate containment leakage rate with time between tests. This lack of quantification also makes it difficult to assess the potential risk impacts of alternate local leakage-testing schedules.

6.3 ON-LINE MONITORING

On-line monitoring has been considered as a possible alternative and/or a supplement to existing containment leakage-testing methods. On-line monitoring would have the advantage of providing a continuous indication of certain aspects of containment integrity. OLM appears to be well suited to detecting possible "gross" containment isolation failures in systems directly connected to the containment atmosphere;

however, OLM would not detect isolation valve leakages in systems closed to the containment atmosphere during normal operation.

Regulatory/Safety Objective

Same as stated for Type A tests. Additionally, to detect certain unintentional breaches of containment integrity on a continuous basis.

As noted earlier, past and current probabilistic risk assessments demonstrate that population risks are quite insensitive to containment leakage rate. Since on-line monitoring appears to be well suited to detecting unintentional breaches of containment integrity such as containment isolation failure, it is instructive to consider the risk impact of this containment failure mode. In NUREG-1150, the PRA model results for the Surry unit found the probability of containment isolation failure to be $2E-4$. The expected population risk contribution of containment isolation was found to be approximately 0.1 percent of the total of 31 person-rem/yr.

Potential Issues

Since the various on-line monitoring concepts operate at or near normal containment pressure, their sensitivities may be limited and may thus require finite time periods for performing the required leakage-rate measurements. Thus, in practice, on-line monitoring may provide frequent periodic status of containment integrity. On-line monitoring would have the disadvantage of being able to detect leakages only through direct air paths. Also, since the containment leakage rates at normal conditions cannot be extrapolated to those at accident temperatures and pressures with any degree of accuracy, OLM does not accomplish the same objectives as the integrated containment leakage test.

6.4 PERFORMANCE-BASED ALTERNATIVES

Performance-based alternatives are defined as variations in current Appendix J leak-tightness

and testing frequency requirements. On-line monitoring is considered separately.

Leakage Rate

For both ILRTs and LLRTs, relaxing the acceptance criteria is considered in combination with changes in testing frequency as defined below.

Frequency

For ILRTs, alternatives considered to the baseline of three ILRTs every 10 years are testing intervals of two times in 10 years, one in 10, and one in 20 years.

For LLRTs, which involve individual testing of multiple penetrations and valves, variation of the frequency is more complicated. The baseline requirement (in the current Appendix J) is basically 100 percent testing at least every 2 years. Extensive data from previous tests indicate that virtually all failures are associated with Type C valves, and it has been postulated that these failures are largely repetitive (i.e., "leakers" are known) (NRC93B). Thus, testing only lower-reliability isolation valves on the current at-least-once-every-2-year schedule is one alternative. However, a large data base will be necessary to support the assertion that the "leakers" are known.

Alternatives

To estimate the potential cost savings, a testing schedule consistent with the current requirements must be defined; then, alternative testing schedules can be compared to it. Most reactors are licensed for 40 years and operate on an 18-month refueling cycle. With consideration of outage times, this results in 24 power cycles over the lifetime of the reactor. Without license extension, the average reactor has about 20 years of operations remaining. Therefore, the baseline costs of remaining Appendix J testing are those associated with Power Cycles 13 through 24. An idealized 20-year test schedule, consistent with Appendix J and the 10-year

in-service inspection requirement, is used to estimate the present worth of the remaining costs of complying with the current Appendix J requirements. The schedule assumes that LLRTs (Type B & C tests) are conducted every refueling outage and that ILRTs (Type A test) are conducted every other refueling outage.

To evaluate the impact of license extension, the assumed testing schedule was extended to cover an additional 20 years of operation (Power Cycles 25 through 36).

Costs of the alternatives are estimated by making appropriate modifications (cost per test and/or frequency of tests) to the 20-year and 40-year baseline estimates.

An additional alternative would impose a requirement to design, install, and operate an on-line monitoring system.

Alternative 1 maintains the current Appendix J frequency requirements but relaxes the acceptance criteria.

Alternative 2 maintains the current Appendix J acceptance criteria but relaxes the ILRT frequency from three per 10 years to two per 10 years.

Alternative 3 relaxes the current Appendix J acceptance criteria and relaxes the ILRT frequency from three per 10 years to two per 10 years.

Alternative 4 maintains the current Appendix J acceptance criteria but relaxes the ILRT frequency from three per 10 years to one per 10 years.

Alternative 5 relaxes the current Appendix J acceptance criteria and relaxes the ILRT frequency from three per ten years to one per 10 years.

Alternative 6 maintains the current Appendix J acceptance criteria but relaxes the ILRT

Alternatives

frequency from three per 10 years to one per 20 years.

Alternative 7 relaxes the current Appendix J acceptance criteria and relaxes the ILRT frequency from three per 10 years to one per 20 years.

Alternative 8 maintains the current Appendix J acceptance criteria and the ILRT frequency of three per 10 years but relaxes LLRTs to allow testing of only the "lower-reliability" penetrations during refueling outages.

Alternative 9 relaxes the current Appendix J acceptance criteria and maintains the ILRT frequency at three per 10 years, but relaxes LLRTs to only "lower-reliability" penetrations during refueling outages.

Alternative 10 maintains the current Appendix J acceptance criteria, relaxes the ILRT frequency to two per 10 years, and relaxes LLRTs to only "lower-reliability" penetrations during refueling outages.

Alternative 11 relaxes the current Appendix J acceptance criteria, relaxes the ILRT frequency to two per 10 years, and relaxes LLRTs to only "lower-reliability" penetrations during refueling outages.

Alternative 12 maintains the current Appendix J acceptance criteria, relaxes the ILRT frequency to one per 10 years, and relaxes LLRTs to only "lower-reliability" penetrations during refueling outages.

Alternative 13 relaxes the current Appendix J acceptance criteria, relaxes the ILRT frequency to one per 10 years, and relaxes LLRTs to only "lower-reliability" penetrations during refueling outages.

Alternative 14 maintains the current Appendix J acceptance criteria, relaxes the ILRT frequency to one per 20 years, and relaxes LLRTs to only "lower-reliability" penetrations during refueling outages.

Alternative 15 relaxes the current Appendix J acceptance criteria, relaxes the ILRT frequency to one per 20 years, and relaxes LLRTs to only "lower-reliability" penetrations during refueling outages.

The alternatives defined above are summarized in Table 6-1. The risk impacts of each of these alternatives are evaluated in Chapter 7.

Table 6-1. Alternatives

ALTERNATIVE	FREQUENCY				LEAKAGE RATE	
	NO CHANGE		RELAX		NO CHANGE	RELAX
	A	B/C	A (Tests per X Years)	B/C		
1	X	X				X
2		X	2/10		X	
3		X	2/10			X
4		X	1/10		X	
5		X	1/10			X
6		X	1/20		X	
7		X	1/20			X
8	X			X	X	
9	X			X		X
10			2/10	X	X	
11			2/10	X		X
12			1/10	X	X	
13			1/10	X		X
14			1/20	X	X	
15			1/20	X		X

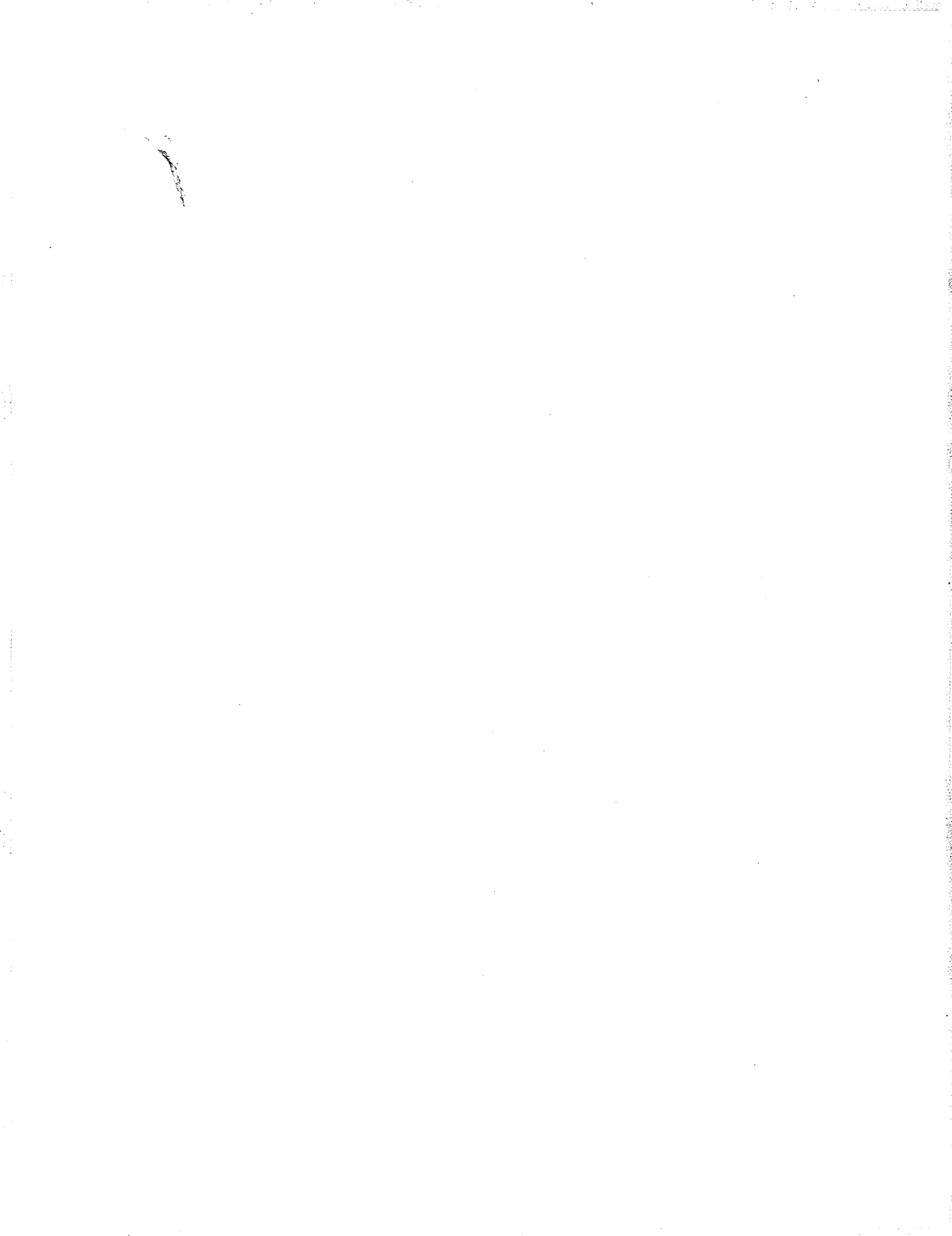

7. Risk Impacts of Alternative Appendix J Requirements

This chapter presents qualitative and quantitative assessments of the consequences of alternatives to the current Appendix J rule. While the quantitative evaluation presents numerical results useful for comparison and for an understanding of the magnitude of the changes under consideration, the qualitative discussion sets the context and lends perspective to the quantitative results. The qualitative discussion addresses items such as the "importance" of containment leakage rate, the relationship between the Appendix J analysis and the NRC's Safety Goal Program, and the uncertainties which are part of this study.

7.1 QUALITATIVE CONSIDERATIONS

Risk Sensitivity of Containment Leakage

Past studies show that overall reactor accident risks are not sensitive to variations in containment leakage rate (NRC86, NRC90). This is because reactor accident risks are dominated by accident scenarios in which the containment fails or is bypassed. Such scenarios, even though they are of very low probability, dominate the predicted accident risks due to their high consequences.

The assessment of the effect of containment leak-tightness on reactor accident risks, described in Chapter 5, confirms the earlier conclusions. The results show that increasing the containment leakage rate several orders of magnitude (100 to 200 fold) over the design basis would have a minimal impact on population risk (ranging from 0.2 to 1 percent for the reactors considered).

Additionally, studies (NRC75) have shown that pre-existing leakage rates of up to 200 containment volume percent per day would have little effect on the containment response. A 200 percent per day leakage rate corresponds to approximately a 3.6-inch diameter opening in the Surry containment shell. The current Appendix J requirements consider the Surry containment to have failed its leakage test if a

leakage rate corresponding to less than the area of a pencil point (0.08-inch diameter opening) is found to exist. The disparity between what current state-of-the-art analyses identify as risk-significant and what the current Appendix J regulation requires provides the perspective for the NRC's marginal-to-safety effort.

NRC Safety Goals

The NRC has adopted the principle that nuclear risks should not be a significant addition to other societal risks. They have developed two qualitative goals supported by two quantitative objectives as a means to gauge the adequacy of regulatory decisions regarding changes to current regulations (NRC86C).

The qualitative goals are:

- *Individual members of the public should be provided a level of protection from the consequences of nuclear power plant operation such that individuals bear no significant additional risk to life and health.*
- *Societal risks to life and health from nuclear power plant operation should be comparable to or less than the risks of generating electricity by viable competing technologies and should not be a significant addition to other societal risk.*

The following quantitative goals are used in determining achievement of the qualitative goals:

- *The risk to an average individual in the vicinity of a nuclear power plant of prompt fatalities that might result from reactor accidents should not exceed one-tenth of one percent (0.1 percent) of the sum of prompt fatality risks resulting from other accidents to which members of the U.S. population are generally exposed.*

Risk Impact of Alternatives

- *The risk to the population in the area near a nuclear power plant of cancer fatalities that might result from nuclear power plant operation should not exceed one-tenth of one percent (0.1 percent) of the sum of cancer fatality risks resulting from all other causes.*

Chapter 5 compares the individual latent cancer fatality risks as a function of containment leakage rate for the reactors assessed in NUREG-1150 (NRC90) and finds that the calculated risks for all the reactors are well below the safety goal (by factors of from 100 to 5000) over the entire range of leakage rates considered.

Uncertainty

Chapter 5 also illustrates the uncertainty range associated with the predicted total latent cancer fatalities per reactor year. For Surry, the 5 - 95 percent confidence interval spans approximately two orders of magnitude (from about 3E-4 to about 2E-2 latent cancer fatalities per year). Comparable ranges of uncertainty are found for the other units considered.

Containment leakage, at an assumed rate of 1 percent per day, contributes about 0.05 percent to the total accident risk at Surry; comparable or even smaller leakage contributions to risk were found for the other units. Since the design basis leakage rate for Surry is 0.1 percent per day, the reference risk results already include a 10-fold "allowance" for increased leakage; comparable increases above the design basis leak rates were incorporated into the assessments for the other units.

Since containment leakage is such a small contributor to overall accident risk, it is clear that at the lower end of the leakage rate ranges considered in this study, any uncertainties associated with the leakage contribution are minuscule in comparison with other uncertainties, e.g., prediction of containment

failure mode probabilities and magnitudes of fission product source terms. The NUREG-1150 results for PWRs predict significant probabilities of no containment failure even in the event of core melt accidents. With the containments predicted to remain intact, at the upper end of the leakage-rate ranges considered, i.e., 200 - 400 percent containment volume per day, containment leakage could lead to several-fold increases in the predicted risk. The expected fission product source terms associated with the large leakage cases, considering all possible unit damage states and accident progression bins, were substantially lower than those resulting from containment failure or bypass. Thus, the uncertainties associated with assessing the leakage contribution at the upper ends of the ranges considered would be lower than those associated with other containment failure modes.

For BWRs the calculated accident risks were found to be very insensitive to the assumed containment leakage rates, even at the upper end of the ranges considered. This is a direct consequence of predicted higher probabilities of early containment failure for the BWRs, i.e., since containments are predicted to fail in a large fraction of the postulated core melt accidents, the assumed containment leakage rate does not contribute significantly to the calculated risk. Also, the scrubbing of the fission products by BWR suppression pools, even in many scenarios involving large leakage rates, contributes to the predicted lack of risk sensitivity to containment leakage rate. Thus, for BWRs the uncertainties associated with assessing the contribution of containment leakage are small compared with other uncertainties in the quantification of accident risks.

7.2 QUANTITATIVE IMPACTS

The risk impacts of alternative Appendix J testing requirements include the potential increased doses to members of the public in the event of severe reactor accidents, potential

decreased doses to members of the public due to reductions in shutdown risks and valve restoration errors, and decreases in occupational exposure resulting from less frequent or different approaches to containment leakage-rate testing. In this study only the potential increased risks to the public and the decreases in occupational exposure are quantitatively addressed. Others, however, have studied the impacts of less frequent testing on shutdown risk, and a summary of their findings is presented later in this section.

As noted earlier, the current study also found that containment isolation failure is a small contributor to reactor accident risk. For the Surry unit, containment isolation failure contributes less than 0.1 percent of the latent risk from reactor accidents; for Sequoyah and Zion, this contribution is less than 1 percent. It has not been possible to quantify the risk contributions of containment isolation failure for the BWRs, since in the NUREG-1150 accident sequence binning procedure, containment isolation failures have been combined with other accident-induced containment failure modes. Containment isolation failures were not assessed explicitly due to their acknowledged low risk significance. This low level of risk contribution is due at least in part to the low predicted probabilities ($2E-4$ to $7E-3$) of isolation failures. The consequences of containment isolation failure in the event of a severe accident can be substantial.

Shutdown Risk

A study of the shutdown risk implications of implementing performance-based changes to 10CFR50 Appendix J has been performed by EPRI, the Electric Power Research Institute (EPRI94). Their study included:

- A review of shutdown operating experience to identify specific initiating events that have occurred as the result of ILRT and LLRT activities.

- A qualitative evaluation of the potential risk implications of ILRT/LLRT test interval extension, including the identification of impacts on initiating event probabilities, mitigation system unavailabilities, containment performance and operator response.
- A quantitative assessment of the risk impact of extending ILRT and LLRT test intervals on the basis of the impact on core damage probability for one BWR and one PWR.

Of the 436 shutdown events that were reviewed only 7 were found to be related to ILRT/LLRT testing activities. This experience was used to guide the subsequent assessment of risk implications. The quantified risk benefit was found to be on the order of 10^{-8} to 10^{-7} per year reduction in predicted core damage frequency. The estimated risk benefit for the BWR was found to be larger than for the PWR. The shutdown risk benefit is due to the reduced opportunity for RCS drain-down events and a reduction in the time spent in configurations where the performance of mitigation systems may be impaired.

The authors of the study conclude that the estimated risk benefit of extended leakage-testing intervals to be measurable. They do not expressly specify the baseline core damage frequencies for the two units considered. Assuming a core damage frequency on the order of 10^{-5} per year, the calculated benefit is of the order of one percent or less. Thus, the calculated risk benefit would appear to be in the same range as the calculated risk impacts.

Type A ILRT

Review of leakage-rate testing experience, described in Chapter 4, indicates that only a small percentage (3 percent) of leakages that exceed current requirements (referred to as Type A test failures) are actually detectable only by

Risk Impact of Alternatives

Type A testing. Further, the leakage rates observed in these few Type A test failures were only marginally above currently prescribed limits. These observations, together with the insensitivity of reactor accident risk to the containment leakage rate, suggest that reducing Type A leakage-test frequency would have a minimal impact on public risk.

Type B & C LLRT

North Anna

The discussion of leakage-rate experience in Chapter 4 indicates that frequent Type B leakage-rate testing of electrical penetrations is of limited use. In approximately 27 unit-years of operation at North Anna, no significant leakage has been found for electrical penetrations. Other units report similar experiences.

North Anna routinely tests and frequently replaces seals on air-locks and other inflatable seals. Thus, there appears to be little basis for trying to characterize the time-dependent performance of such components.

Leakage-rate experience at North Anna and other sites indicates that Type C leakage-rate testing detects the vast majority of leakages that exceed current acceptance criteria. It has been asserted (NRC93B) that isolation valve (Type C) leakages are generally associated with problem components whose identity is known. Thus, by concentrating testing on such "leakers," the required extent of testing would be minimized while assuring a high degree of containment integrity. From the detailed examination of Type C local leakage-rate testing results in this study, it has not been possible to correlate the likelihood of leakage with time based on component parameters. A statistical analysis was performed to determine the correlation of component parameters (type of component and operator, type of service, number of operations per operating cycle, number of operating hours

per operating cycle, manufacturer, type, and flow rate, temperature and pressure seen by component during operation) with the time between maintenance events for similar components. At best, approximately 26 percent of the variability in time between maintenance events could be explained using the above component parameters. A correlation exists between the likelihood of leakage and time since last maintenance considering all components. There is a failure rate per unit time and, if a component leaks at outage n , a higher probability that the same component will leak at outage $n+1$ or $n+2$. (The failure rate, λ , equals $1.3 \times 10^{-2}/\text{yr}$ per component, and the conditional probability of failure for components which have previously failed, β , equals 0.34. Failure is defined as a maintenance event.)

In addition, the leakage rate of a component when it does leak cannot be quantified. This is because the equipment used for local leakage-rate testing can quantify leaks only up to a certain size (e.g., approximately 257 scf/h at North Anna). The range of equipment used for local leakage-rate testing is comparable to the maximum acceptable leakage rate. Since the sum of all local leakages must be below $0.6 L_a$, any individual penetration or valve that approaches such a level of leakage obviously requires repair; thus, under current regulations, there is no need or incentive to quantify leakage rates above these levels. Given these limitations, it is not now possible to quantify precisely the risk impacts of reduced frequency of Type C testing. Nevertheless, estimates of such risk impacts have been made using simplifying assumptions.

A statistical model based on the North Anna Type C test experience was developed which can be used to assess changes in risk based on the expected probability of leakage for various alternative testing schemes. Since it has not been possible to correlate the probability of leakage with component parameters, this model assumes a constant failure rate for all

components. This failure rate, along with a conditional probability of failure given a failure of the component during the prior two tests, was derived from the North Anna Type C test experience. In this model, component failure is defined as leakage of the component at a rate of 250 scf/h or greater.

Grand Gulf

The GGNS proposal includes an analysis of the expected containment performance under the proposed program. This analysis concluded that the risk impacts of the proposed leakage-testing program are small and within the uncertainties associated with the PRA. Thus, the proposed performance based approach to containment leakage testing is projected to lead to considerable savings in resources with minimal impact on public risk.

Conceptually, the GGNS proposal for Type B & C testing is very similar to test scheme option 3 addressed in Appendix A of this report. An evaluation of the Grand Gulf containment penetration performance history (refer to Appendix A) indicates a component dependent failure factor lower than that derived from the North Anna data and a penetration common mode failure probability comparable to that of North Anna. Applying these factors to the several leakage-testing options indicates that the change in incremental risk due to containment leakage rate relative to the current approach would be smaller based on the Grand Gulf data in comparison with North Anna. However, the difference in results based on the two sets of data is not significant.

Comparison of Risk Assessment Methods Used to Analyze North Anna and Grand Gulf Type B/C Performance-Based Leakage-Test Options

Factors used to analyze Type B/C performance-based test options include leakage-rate and failure-rate data, and the mathematical risk models developed to simulate performance.

Leakage-Rate Data

The GGNS method does not explicitly consider component leakage rates to project the expected containment performance under the proposed program. It is limited to potential increases in containment isolation failure probability. Each penetration component is assigned an allowable leakage rate based on its nominal line size. Considering a penetration consisting of two valves in series, the GGNS method assumes that if both valves leak at a rate greater than their allowed leakage rate, containment leakage rate is greater than allowed. This may be conservative as many individual penetrations may have assigned allowable leakage rates that are less than the allowable containment leakage rate.

The analysis of North Anna leakage rates presented in Appendix A is based on historical data from North Anna. While the North Anna history shows small (measurable) as well as unmeasurable leakages, the analysis of the risk impacts of alternative testing schemes is based only on leakage rates of 250 scf/h or greater. The latter represents the limitation of the testing equipment and corresponds approximately to the allowable containment leakage rate. As discussed previously, small leakage rates would have little or no risk impact.

Failure-Rate Data

In the GGNS analysis, generic failure rates based on component type are used. Penetration failure rates are calculated based on independent failures of the components comprising a penetration without considering common mode failures. Also, there seems to be the implication that the probabilities of containment isolation failure and excessive leakage rate are the same. Failure to isolate would typically require the failure to close of two valves in series within a penetration. Excessive leakage can take place even if such valves close, but fail to seal tightly. The latter occurrence could be much more probable than the former. Both these

Risk Impact of Alternatives

considerations introduce nonconservatism into the analysis; however, in light of the small contribution of containment leakage rate to accident risk, these nonconservatism may not be significant.

The analysis of the North Anna data did not show a high degree of correlation in component failure rates due to component type. An average failure rate was assigned to all components based on the actual number of component failures observed at North Anna. Common mode factors for both multiple failures of single components and failures of multiple components in a penetration were derived from the analysis of the data.

Mathematical Risk Models

GGNS uses a Bayesian analysis to assess the impact of increases in Type B/C test intervals, and uses the Individual Plant Examination (IPE) results to set limits on the allowable probability of penetration failure.

The GGNS analysis used the results of their IPE to assess both positive and negative risk impacts for the proposed program. The areas of risk impact investigated were:

- valve performance
- initiating event frequencies
- mitigation system availability
- shutdown risk
- containment isolation failure
- containment bypass

Valve failure modes investigated were:

- internal valve leakage
- failure to open/close on demand
- valve restoration errors
- unavailability due to test and maintenance

The analysis of North Anna presented in Appendix A investigated only the risk impact of valve leakage.

On-Line Monitoring (OLM)

A previous study of OLM (NRC88) concluded that such methods would be best suited to detecting gross leakage through direct air paths, i.e., containment isolation failures. As noted earlier for the Surry and Sequoyah units, containment isolation failure has been found to contribute from 0.1 percent to less than 1 percent of the total latent accident risk. Further, containment penetrations exposed to the containment atmosphere may represent only on the order of 10 percent of the total potential leak paths. Given the low risk attributed to isolation failures and the apparently limited capabilities of OLM systems, the potential risk benefit of OLM appears to be limited.

More recent studies, as discussed in Chapter 4, indicate that OLM systems may be capable of detecting leakage rates of the order of a few percent per day. While this level of leakage is above the current technical specification limits in U.S. units, it is still so low as to be essentially inconsequential in terms of its potential risk contribution. Also, OLM would be limited to detecting leak paths directly connected to the containment atmosphere; it would not detect valve leakages in systems closed to containment atmosphere during normal operation. Thus, OLM does not accomplish the same objectives as integrated leakage-rate testing.

7.2.1 Risk Impacts on the Public

Evaluation of the risk impacts for each of the alternatives requires establishing the baseline risks associated with the current Appendix J acceptance criteria and testing frequencies. Total reactor accident risk can be represented as the sum of the contributions of various leakage paths:

$$\text{Risk (BL)} = \Delta \text{ Risk (NL)} + \Delta \text{ Risk (CF)} + \Delta \text{ Risk (CB)} + \Delta \text{ Risk (IF)}$$

where:

- BL = Baseline
- NL = Nominal Leakage
- CF = Containment Failure
- CB = Bypass Containment
- IF = Isolation Failure

Changes in containment leakage rate will not affect the risk contributions due to containment failure, bypass, or failure to isolate. Changes in leakage rate will only affect the risk contribution of those accident scenarios in which the containment remains intact. Thus, the risk impacts of changes in containment leakage rate due to various testing alternatives can be represented as:

$$\text{Risk (Alternative)} = [\text{Risk (BL)} - \Delta \text{ Risk (NL)}] + \Delta \text{ Risk (Alt)}$$

The foregoing expression simply substitutes the incremental risk contribution of leakage associated with alternate testing approaches for the risk contribution associated with nominal leakage under current Appendix J requirements, and the terms in the square brackets represent the risk with zero leakage. Since risk is the product of probability and consequence,

$$\text{Risk (Alt)} = [\text{Risk (BL)} - \Delta \text{ Risk (NL)}] + \Delta \text{ Probability (Alt)} \times \text{Consequence (Alt)}$$

For the evaluation of the risk impacts of the various testing alternatives considered, the last term in the foregoing equation was quantified.

Increasing the allowable leakage rate would not affect the probability of leakage. Thus, for alternatives which include increased leakage rate (identified in Table 6-1 as Alternatives 1, 3, 5, 7, 9, 11, 13, and 15), only the consequences of increased leakage need to be considered.

Using the PRA for Surry as an example (NRC90), the base case risk is determined to be 0.31 person-Sievert (31 person-rem) per reactor year. The contribution to this total risk attributed to accident scenarios that do not involve the bypass or failure of containment (i.e., the "leakage" scenarios) is very small, on the order of 0.00018 person-Sievert (0.018 person-rem) per reactor year for an assumed leakage rate of 1 percent per day (the design leakage rate for Surry is 0.1 percent per day). The relative contributions of containment leakage rate to reactor accident risk for the other units considered in Chapter 5 are comparable or lower than those for Surry. Since the relative contribution of leakage to reactor accident risk for Surry envelopes those for the other units, the following discussion is based on the Surry results. The essential insights would be unchanged if the actual numerical results for other units were utilized. Where somewhat different insights are derived from the results for other units, they are noted.

For the alternatives involving increases in the ILRT testing intervals (identified in Table 6-1 as Alternatives 2 through 7 and 10 through 15), it was assumed that the characteristic magnitude of leakages detectable only by ILRTs would not change, but the probability of leakage would change due to the longer intervals between tests. As stated in Chapter 4, ILRTs detected leakages in only about 3 percent of all tests, and these leakages were characterized by a leakage rate of about two times the allowable. For the existing ILRT frequency of three tests every ten years, the average time that a leak could be undetected is 1.5 years (3yrs/2). If the frequency is changed to two tests every ten years, the average time that a leak could exist without detection would be 2.5 years (5yrs/2). This change would lead to a factor of 1.67 increase (2.5/1.5) in the likelihood of a leak that is detectable only by ILRT testing. However, since ILRTs detect leaks in only about three percent of all tests, this change would result in about a five percent (1.67 x 3 percent) increase in the probability of an undetected leak.

Risk Impact of Alternatives

For alternatives involving increases in the LLRT testing intervals (identified in Table 6-1 as Alternatives 8 through 15), small deviations from the allowable leakage were demonstrated to have minimal impact on risk. Thus, only unquantified leakages were considered in the risk impact analysis since they had the potential of being risk significant. The analyses in Appendix A found that the various performance-based alternatives considered were bounded by a factor of three increase in the likelihood of an unquantified leakage. Since the differences in the increase in leakage probability among the various alternatives were not large, it was decided to assess only the factor of three increase in the probability of an unquantified leakage, rather than considering all the cases individually. This defined the likelihood of increased leakage due to decreases in the LLRT frequency. The Appendix A analysis also indicated that under the existing leakage-test requirements, unquantified leakages could be expected approximately 15 percent of the time. To assess incremental risk due to unquantified leakage, a characteristic leakage rate is necessary.

NUREG-1150 provided a characterization of the consequences of containment isolation failure; these are large leakages resulting from the failure of containment penetration isolation valves to close. Since the types of leakages found by LLRT are due to failure to seal rather than the failure to close, the leakages and consequences of the former are smaller than those of the latter. Thus, the consequences of the types of failures detected by LLRTs were taken to be the median of the isolation failures and nominal leakage. This approach recognized that the unquantified leakages could substantially exceed nominal levels without using overly conservative characterizations such as containment failure. For Surry, NUREG-1150 calculated an average consequence for core melts with containment isolation failure of 3.874E6 person-rem; for an average core melt with nominal leakage the corresponding consequence is 526.9 person-rem. The median of these values is 45,180 person-rem; this is the value

used to characterize the potential consequences of unquantified leakages.

Alternative 1: Alternative 1 simply relaxes the acceptable leakage rate criteria; testing frequencies are unchanged. As the PRA results for Surry are based on a 1 percent/day leakage rate and as the actual design basis leakage rate for Surry as well as many other PWRs is currently 0.1 percent/day, the conclusion is that a relaxation of the leakage rate within a factor of 10 will not have a distinguishable impact on the population risk. Embedded in the 0.018 person-rem/year leakage contribution is an average consequence of about 530 person-rem and a frequency of about 3.39E-5 of core melt with no containment failure. Increasing the allowable leakage by a factor of ten will have no effect on accident risk, since a leakage rate of that magnitude has already been assumed in the risk assessment. Increasing the leakage rate by a factor of one hundred over the design basis value, to 10 percent per day, would increase the containment leakage contribution to risk from 0.00018 to 0.0018 person-Sievert (0.018 to 0.18 person-rem) per year. Thus, the overall risk of this alternative will be (for convenience, the units will not be repeated in the following):

$$\text{Risk (Alt 1)} = (31.0 - 0.018) + 0.18 = 31.162 \text{ person-rem/year}$$

The percent increase in risk of Alternative 1 over the base case is:

$$[31.162 - 31.0] \times 100 \% = 0.52 \%$$

Thus, the increases in risk contribution due to leakage, assuming a factor of 100 increase in the allowable leakage rate and rounding off, range from about 0.2 to 1 percent for the five reactors considered.

Alternative 2: Alternative 2 retains the current leakage rate criteria and LLRT frequencies and reduces the frequency of ILRTs from three per 10 years to two per 10 years. As indicated earlier, ILRTs detect about 3 percent of leaks that are otherwise undetectable. As no data are

available to establish the time-dependency of failures, it is reasonable to assume that failures occur randomly over time. Relaxing the ILRT frequency from 3 in 10 years to 2 in 10 years will increase the average time that a leak—that is detectable only by ILRTs—goes undetected, from 18 to 30 months, a factor of 1.67. Since ILRTs detect only about 3 percent of leaks, this results in only about a 5 percent increase in the overall probability of leakage. The small number of leaks detectable only by ILRTs were characterized by only marginal deviations from existing requirements ($\sim 2 L_d$). Combining these factors, i.e., increasing the probability of leakage by 5 percent and doubling the incremental risk contribution of leakage, yields a risk associated with this alternative of:

$$\begin{aligned} \text{Risk (Alt 2)} &= (31.0 - 0.018) + \\ &(1.05 \times 2 \times 0.018) = 31.0198 \text{ person-} \\ &\text{rem/year} \end{aligned}$$

The percent increase in risk of Alternative 2 over the base case is:

$$\begin{aligned} [(31.0198 - 31.0) / 31.0] \times 100\% &= \\ 0.064\% \end{aligned}$$

Thus, the increase in risk contribution due to a relaxed ILRT test frequency from three in ten to two in ten years and rounding off, is about a 0.06 percent for Surry; the corresponding results for the other units ranged from 0.02 to 0.13 percent. The incremental risk impact of other ILRT test frequencies is calculated similarly.

Alternative 3: Since this alternative combines the relaxed leakage-rate criteria of Alternative 1 with the two in 10 years ILRT frequency of Alternative 2, the risk impact is simply the sum of the risk impacts calculated for those two alternatives, i.e., an incremental risk of about 0.0022 person-Sievert (0.22 person-rem) per year. This incremental increase is barely perceptible within the total calculated accident risk of 0.31 person-Sievert (31 person-rem) per year. For the five reactors considered, the calculated risk increases range from 0.2 to 1.3 percent.

Alternative 4: Alternative 4 is identical to Alternative 2, except the ILRT frequency is reduced to one in 10 years. Relaxing the ILRT frequency from 3 in 10 years to 1 in 10 years will increase the average time that a leak that is detectable only by ILRTs goes undetected from 18 to 60 months, a factor of 3.33 increase. Since ILRTs detect only about 3 percent of leaks, this results in about a 10 percent increase in the overall probability of leakage. The small number of leaks detectable only by ILRTs were characterized by only marginal deviations from existing requirements ($\sim 2 L_d$). Combining these factors, i.e., increasing leakage probability by 10 percent and doubling the incremental risk contribution of leakage, yields a 0.07 percent risk increase for Surry; the corresponding results for the other units ranged from 0.02 to 0.14 percent.

Alternative 5: Since this alternative combines the relaxed leakage-rate criteria of Alternative 1 with the one in 10 years ILRT frequency of Alternative 4, the risk impact is simply the sum of the risk impacts calculated for those two alternatives, i.e., an incremental risk for Surry of about 0.0022 person-Sievert (0.22 person-rem) per year. This incremental risk is imperceptible within the total calculated accident risk of 0.31 person-Sievert (31 person-rem) per year. The increases range from 0.2 to 1.3 percent for the five reactors.

Alternative 6: Alternative 6 is identical to Alternative 2, except the ILRT frequency is reduced to one in 20 years. Relaxing the ILRT frequency from 3 in 10 years to 1 in 20 years will increase the average time that a leak—that is detectable only by ILRTs—goes undetected from 18 to 120 months, a factor of 6.67. Since ILRTs detect only about 3 percent of leaks, this results in about a 20 percent increase in the overall probability of leakage. The small number of leaks detectable only by ILRTs were characterized by only marginal deviations from existing requirements ($\sim 2 L_d$). Combining these factors, i.e., increasing leakage probability by 20 percent and doubling the incremental risk contribution of leakage, yields a 0.08 percent

Risk Impact of Alternatives

risk increase for Surry; the corresponding results for the other units ranged from 0.02 to 0.16 percent.

Alternative 7: Since this alternative combines the relaxed leakage-rate criteria of Alternative 1 with the one in 20 years ILRT frequency of Alternative 6, the risk impact is simply the sum of the risk impacts calculated for those two alternatives, i.e., an incremental risk for Surry of about 0.0023 person-Sv (0.23 person-rem) per year. This incremental risk is barely perceptible within the total calculated accident risk of 0.31 person-Sv (31 person-rem) per year. The increases range from 0.2 to 1.3 percent for the five reactors.

Alternative 8: Alternative 8 maintains the current Appendix J leakage-rate criteria and ILRT frequency, but reduces LLRTs to only "lower reliability" penetrations during refueling outages. The risk impacts of this change can be estimated in a manner similar to that used for changes in the ILRT frequency if the impact of such reduced testing on leak probability can be assessed. The ILRT data base as well as the detailed examination of the North Anna leakage-testing experience indicate about a 15 percent chance that the allowable leakage rate will be exceeded at any point in time. The alternate Type C testing schemes discussed in Chapter 6 and Appendix A appear to be capable of reducing the amount of testing without dramatically increasing the probability of risk-significant containment leakage. A factor of three increase in the probability of exceeding allowable leakage rate appears to envelope the results for the various performance-based alternatives considered in Appendix A. The incremental risk increase of performance-based LLRT testing is the product of a factor of three increase in the likelihood of such leakage, times the fraction of time that such leakages existed under the current requirements, times the consequences of such leakages, times the frequency per year of core melts with no containment failure. Using Surry as the

example, the risk of changing LLRT testing intervals is:

$$\text{Risk (Alt 8)} = (31.0 - 0.018) + (3 \times 0.15 \times 45,180 \times 3.3922\text{E-}5) = 31.6717 \text{ person-rem/year}$$

The percent increase in risk of Alternative 8 over the base case is:

$$[(31.6717 - 31.0)/31.0] \times 100 \% = 2.2 \%$$

Thus, the incremental risk impact for Surry of reduced type C testing corresponds to a 16.8 percent per day leakage rate 45 percent of the time, with an increase in population exposure of 2.2 percent; the range for the other units is 0.2 to 4.4 percent.

Alternative 9: Since this alternative combines the relaxed leakage-rate criteria of Alternative 1 with the lower-reliability-penetration-only LLRT testing of Alternative 8, the risk impact is simply the sum of the risk impacts calculated for those two alternatives, i.e., 0.0087 person-Sievert (0.87 person-rem) per year for Surry, corresponding to a 2.8 percent increase. For the other units the increases range from 0.4 to 5.6 percent.

Alternative 10: Alternative 10 maintains the current leakage-rate criteria but relaxes the ILRT frequency to two in 10 years and LLRTs to "lower-reliability" penetrations only during refueling outages. As previously noted, the change in ILRT frequency results in an imperceptible increase in accident risk. The change in LLRT testing combined with the ILRT change had a 0.3 percent risk increment for Surry. The increases for the other units range up to 4.6 percent.

Alternative 11: Since this alternative combines the relaxed leakage-rate criteria of Alternative 1 with the reduced ILRT and LLRT frequencies of Alternative 10, the risk impact is simply the sum of the risk impacts calculated for those two

alternatives, i.e., 0.0091 person-Sievert (0.91 person-rem) per year for Surry, a 2.9 percent increase. For the other units the increases range from 0.4 to 5.8 percent.

Alternative 12: Alternative 12 maintains the current leakage-rate criteria but relaxes the ILRT frequency to one in 10 years and LLRTs to "lower-reliability" penetrations only during refueling outages. The change in ILRT frequency together with reduced LLRTs were assessed to lead to increases of 0.2 to 4.7 percent in overall accident risk.

Alternative 13: Since this alternative combines the relaxed leakage-rate criteria of Alternative 1 with the reduced ILRT and LLRT frequencies of Alternative 10, the risk impact is simply the sum of the risk impacts calculated for those two alternatives, i.e., 0.0091 person-Sievert (0.91 person-rem) per year in the case of Surry, a 2.9 percent increase. The results for the five units range from 0.4 to 5.8 percent increases in calculated risk.

Alternative 14: Alternative 14 maintains the current leakage-rate criteria but relaxes the ILRT frequency to one in 20 years and LLRTs to "lower-reliability" penetrations only during refueling outages. These changes in testing frequency are estimated to increase overall risk from 0.2 to 4.7 percent.

Alternative 15: Since this alternative combines the relaxed leakage-rate criteria of Alternative 1 with the reduced ILRT and LLRT frequencies of Alternative 14, the risk impact is simply the sum of the risk impacts calculated for those two alternatives. The resulting increases for the five units range from 0.4 to 5.8 percent.

7.2.2 Risk Impacts on Occupational Exposure

Changes in the Appendix J requirements would result in lower routine occupational exposures of the workers involved in conducting the ILRTs

and LLRTs. Based on data from a single utility, ILRTs result in approximately 0.004 person-Sievert (0.4 person-rem) per test and LLRTs result in approximately 0.024 person-Sievert (2.4 person-rem) per test. For alternatives that alter the ILRT frequency, the estimated occupational exposure for ILRTs would be eliminated for each test that is eliminated. For alternatives that provide for "lower reliability" LLRTs, the LLRT exposure would be reduced in proportion to the number of penetrations not tested. No change in occupational exposures is expected for alternatives that simply relax the leakage-rate criteria.

For the 20-year baseline, all remaining testing (ILRTs and LLRTs) is estimated to result, on a per reactor basis, in 0.284 person-Sievert (28.4 person-rem) of occupational exposure. For the 40-year baseline, the estimate is 0.596 person-Sievert (59.6 person-rem) of exposure. The reduction in occupational exposure for each of the alternatives is presented below.

Alternative 1: no change for either the 20-year or 40-year baseline.

Alternatives 2 and 3: occupational exposures would be reduced by 0.008 person-Sievert (0.8 person-rem) for the 20-year baseline and 0.016 person-Sievert (1.6 person-rem) for the 40-year baseline.

Alternatives 4 and 5: occupational exposures would be reduced by 0.016 person-Sievert (1.6 person-rem) for the 20-year baseline and 0.032 person-Sievert (3.2 person-rem) for the 40-year baseline.

Alternatives 6 and 7: occupational exposures would be reduced by 0.020 person-Sievert (2.0 person-rem) for the 20-year baseline and 0.040 person-Sievert (4.0 person-rem) for the 40-year baseline.

Risk Impact of Alternatives

Alternatives 8 and 9: occupational exposures would be reduced by 0.072 person-Sievert (7.2 person-rem) for the 20-year baseline and 0.144 person-Sievert (14.4 person-rem) for the 40-year baseline.

Alternatives 10 and 11: occupational exposures would be reduced by 0.104 person-Sievert (10.4 person-rem) for the 20-year baseline and 0.208 person-Sievert (20.8 person-rem) for the 40-year baseline.

Alternatives 12 and 13: occupational exposures would be reduced by 0.136 person-Sievert (13.6 person-rem) for the 20-year baseline and 0.272 person-Sievert (27.2 person-rem) for the 40-year baseline.

Alternatives 14 and 15: occupational exposures would be reduced by 0.152 person-Sievert (15.2 person-rem) for the 20-year baseline and 0.304 person-Sievert (30.4 person-rem) for the 40-year baseline.

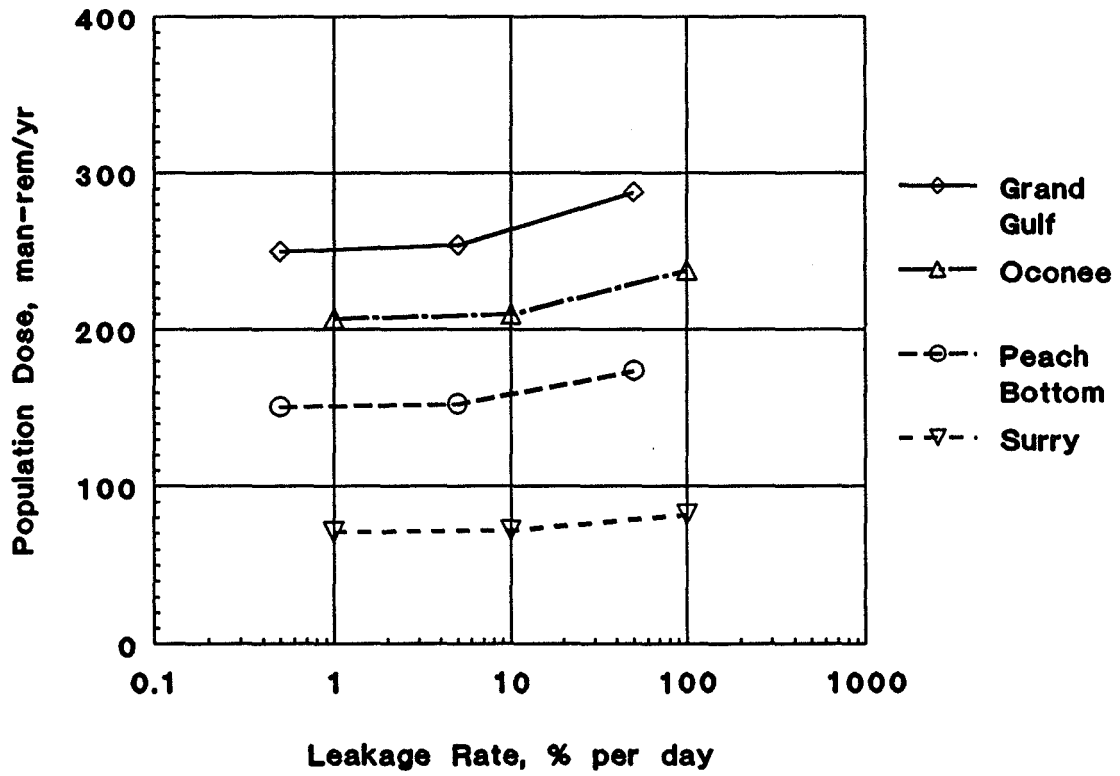

Figure 7-1. Sensitivity of Risk to Containment Leakage Rate

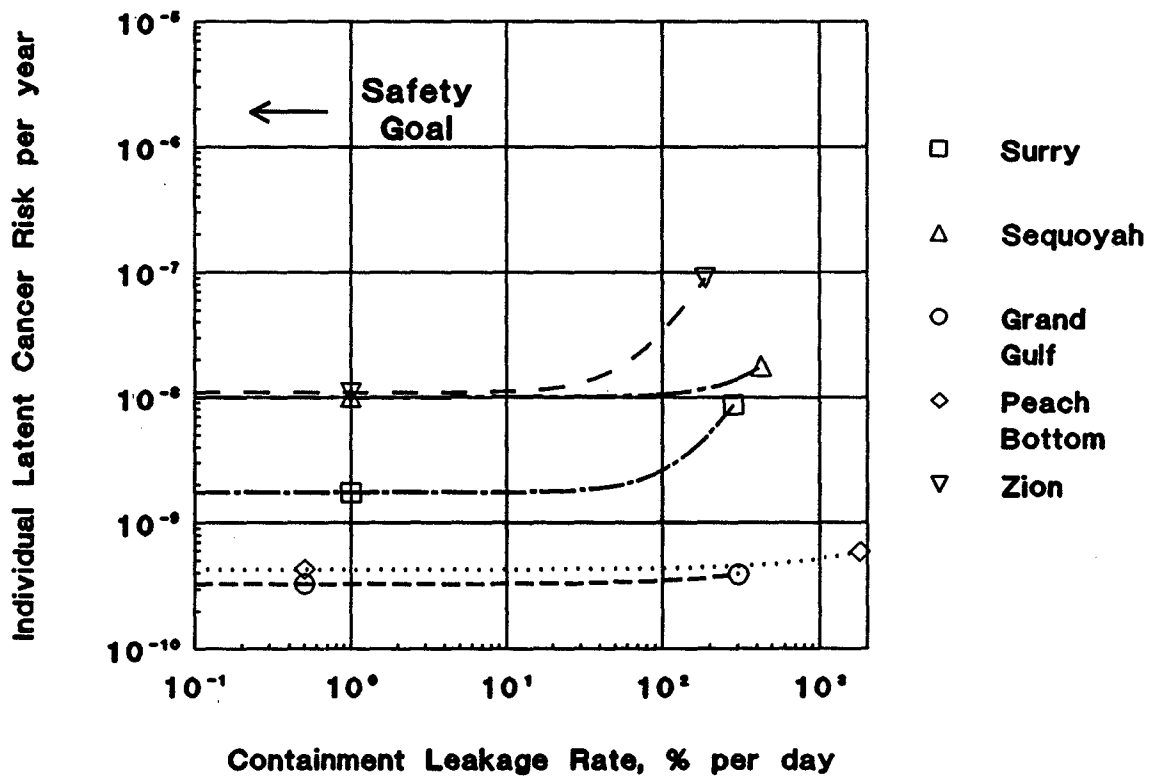

Figure 7-2. Comparison of Individual Latent Cancer Risks with NRC Safety Goal

8. Cost Incurred in Meeting Appendix J Requirements

The significant costs incurred in meeting the testing requirements set forth in 10 CFR 50, Appendix J include labor, equipment, and replacement power. For the purpose of evaluating the impacts of alternative testing requirements, costs of conducting ILRTs and LLRTs are developed for a generic light-water reactor (LWR) on a per test basis. The estimates are based on limited data provided to the NRC by the industry and an evaluation of the labor, equipment, and critical path time needed to perform the tests. For comparison, data reported in early studies are also presented.

8.1 SUMMARY OF DATA REPORTED IN EARLIER STUDIES AND BY INDUSTRY

Review of Industry Cost Information

Information on labor hours, testing procedures, and test summaries for performing ILRTs and LLRTs were provided by Virginia Power's North Anna Station. For ILRTs, the information provided indicates that approximately 3,500 person-hours are required to perform the system alignments, drainings, rigging of containment, inspections and walkdowns, and the post-test restoration of the containment. Additionally, the rental of the air compressors and air dryers, and the services of a test coordinator are estimated at \$100 thousand per test. ILRTs have required approximately five days of critical path time per test.

For LLRTs, which are performed using utility personnel and equipment, the labor estimate is approximately 2,500 hours for a complete battery of Type B and C tests. Type B testing of electrical penetrations accounts for only about 15 percent of the estimated labor hours. Type C tests, which involve testing the valves on approximately 90 penetrations, are more complicated and time-consuming and account for about 85 percent of the total labor hours. A breakdown of labor hours by craft was not provided for either ILRT or LLRT testing.

Grand Gulf Nuclear Station and Calvert Cliffs also provided some cost information to the NRC (NRC93B). The information provided by Calvert Cliffs simply states that the cost of performing an ILRT is \$1.8 million. While no basis for this cost is given, it is consistent with the value used in this report. Grand Gulf states that LLRTs, which are performed by contract personnel, cost \$0.53 million per outage. As the costs cited by Grand Gulf for LLRTs are far greater than those estimated for North Anna, additional information was requested and obtained from Grand Gulf (GG93). This additional information indicates that there are approximately 140 Type C penetrations and that the estimate of LLRT costs includes time for training personnel, non-productive time for the contract personnel, quality assurance oversight by utility personnel, and clerical support to record and archive the test results.

Review of NUREG/CR-4330 Cost Data

The basic data presented in NUREG/CR-4330 (NRC86) for the costs of ILRTs and LLRTs is taken from SEA85. The cost of an ILRT is cited as \$1.3 to \$2.6 million, and considers replacement power, the costs of equipment rental, and a consultant to oversee the test. However, the estimate does not include the labor costs associated with rigging the containment for testing and restoring system alignments at the conclusion of the test.

The cost of LLRTs is cited as \$15,400, based on 367 labor hours for mechanics and engineers and a nominal 10 hours of top-level supervision. No replacement power costs are estimated as LLRTs are not conducted on the critical path. The estimate in SEA85 of 367 labor hours is based on a very rough task analysis for a generic LWR, prepared primarily to estimate potential occupational radiation exposures. As the critical factor for the analysis was time spent in radiation fields, no effort was made to account for time spent in planning, setup, data analysis, etc.

Cost

NUREG/CR-4330 also presents estimates of the costs to industry for implementation of the current requirements, and for the NRC for implementation and operations. These costs, on the order of tens to thousands of dollars per reactor, are insignificant in comparison with the cost savings estimated for any of the alternatives.

In addition to the estimates of the costs for leakage-rate testing, NUREG/CR-4330 estimates the cost savings to industry that would result from reduced failure rates associated with a higher allowable leakage rate. The estimate is based on savings for ILRTs only. As NUREG/CR-4330 was published in June of 1986, it relied on industry practice and experience from the 1970s and early 1980s. During that time frame, "as-found" leakage rates were seldom established by utilities on the basis of LLRTs preceding the ILRT. As a result, when the ILRT identified a leakage path, repairs or isolation were affected, and the test was extended until a "successful" result was obtained. In the mid-1980s, the NRC clarified its interpretation of the "as-found" requirement, with the result that utilities changed their procedures to assure that LLRTs were completed and necessary component repairs made prior to the commencement of the ILRT. This change in industry practice makes it questionable whether or not the reductions in critical path time estimated in NUREG/CR-4330 would actually be achieved by industry.

8.2 CURRENT STUDY COST ANALYSIS

8.2.1 Cost of Type B & C Tests (LLRTs) - Current Appendix J Requirements

Local leakage-rate tests of containment penetrations must be performed at intervals that do not exceed two years, with the exception of air-lock testing which must be performed at least every six months. As the Type B and C tests need not be performed on the critical path, and

as the tests are usually performed by utility personnel using equipment already owned by the utility, costs of LLRTs are estimated simply on the basis of the required labor hours.

Only limited data for Type B and C testing are available from industry. Virginia Power provided an estimate, derived from its North Anna PWRs, of 2,500 labor hours for a complete battery of tests, equating to \$87,500 at a \$35/hr labor rate. Grand Gulf Nuclear Station (GGNS), a BWR, provided an estimate of approximately 20,000 labor hours for a complete battery of tests, equating to \$700,000 at the same labor rate. A careful review of the two estimates indicates that neither can be used directly for the purpose of estimating the costs for a generic LWR. The Virginia Power estimate does not include support personnel, and PWRs have significantly fewer penetrations to test than BWRs (approximately 90 versus approximately 175). The GGNS estimate reflects both the greater number of penetrations at a BWR and the cost of having the tests performed by contractor rather than utility personnel. The GGNS costs also reflect having the entire contractor crew available for the duration of the outage, even when LLRTs are not being conducted for various reasons, such as system availability and maintenance.

In attempting to reconcile these disparate data, the basis for each estimate resulted in the following insights:

1. the North Anna data do not fully reflect all support personnel involved in the testing;
2. the number of Type C penetrations at a BWR is far greater than at a PWR; and,
3. the contractual arrangement under which Grand Gulf performs its LLRTs results in attributing additional costs to LLRTs.

Given these insights, the cost for a full battery of Type B & C tests for a typical LWR was re-estimated to be about \$165,000, on the following basis:

1. a test of a typical Type C penetration lasts about 8 hours and is performed by a 3-person crew consisting of a LLRT operator and pipefitters;
2. the battery of Type B & C tests requires support from scheduling, surveillance, engineering, and operations - on a per Type C test basis, this support is estimated to be 12 hours;
3. a typical LWR has 110 Type C penetrations that require LLRTs based on a weighted average of PWRs and BWRs;
4. the average labor cost is \$35/hour; and
5. the cost for Type B testing is about 15% of total LLRT costs.

Individual utilities may experience higher costs based upon regional labor rates, specific contractual arrangements and their specific refueling cycle.

8.2.2 Costs of Type A Tests (ILRTs) - Current Appendix J Requirements

Integrated leakage-rate tests of containment integrity must be performed at least three times in a 10-year period, with the third test coinciding with the 10-year in-service inspection (ISI). Unlike LLRTs, which are typically performed entirely by utility personnel using test equipment owned by the utility, utilities frequently contract for consultants to supervise the ILRTs and rent the air compressors and air handling systems needed for the tests. Thus, equipment rental costs need to be considered as well as labor costs. Moreover, ILRTs, which require specifically rigging the containment for

the test, are always conducted on critical path time. Therefore, replacement power costs must also be included in estimating the costs of conducting ILRTs.

Based on data provided by Virginia Power, equipment rental and the services of the test coordinator are given as \$100,000 per test. The labor-hours needed to establish the requisite system alignments, drainings, fillings, and surveillance are estimated to be 3,500 per test. Using \$35 per labor-hour results in a labor cost estimate of \$122,500. As Type B and C testing must be performed as a prerequisite to the ILRT, an additional labor cost of \$165,000 is incurred. Finally, the costs of replacement power must be added to these costs. An ILRT can take from 3 to 5 days, depending upon such factors as test pressure, time required to achieve stabilization of pressure and temperature, duration of the test portion, duration of the verification test, and, of course, ability to achieve suitable test conditions. For the utility that provided data for two of its units, ILRTs require about 5 days. As the average replacement energy cost is \$300,000 per day (NRC91A), total replacement energy costs are estimated to be \$1.5 million per test. Using these estimates, the total cost for an ILRT is estimated to be \$1.89 million.

8.2.3 Effects of Relaxing the Acceptance Criteria on ILRT and LLRT Costs

ILRT Costs

Relaxing the acceptance criteria for ILRTs should result in shorter duration tests. Relaxing the acceptance criteria would have no effect on the time necessary to bring the containment into the proper configuration for performing the test, the time to pressurize the containment, the minimum 4-hour stabilization period, the time for depressurization, or the time to re-establish system configurations for power operations at the conclusion of the test. However, relaxing the acceptance criteria should make it much

Cost

easier to establish that containment integrity is verified with a short duration (6-8 hour) test rather than the more usual 24-hour test. The extension of the test period to assure a successful verification test should also be less. A rough estimate is that relaxing the acceptance criteria would result in a savings of 16 hours of critical path time. As replacement power costs are \$300,000 per day (NRC91A), this savings would reduce the cost of an ILRT (Type A test) by \$200,000 from \$1.89 million to \$1.69 million.

LLRT Costs

Relaxing the acceptance criteria for LLRTs (Type B & C tests) will not have any significant cost implications. This conclusion is based on the small number of penetrations that currently fail, and the even smaller number of penetrations that marginally fail. Costs of rework and retesting would be avoided in only a few percent of the tests. For the purposes of this study, we estimate that 5 percent of the total costs of Type B & C testing could be saved if the acceptance criteria are relaxed.

8.2.4 Effects of Reducing the Frequency of ILRTs and LLRTs on Utility Costs

As discussed above, the costs of meeting the current Appendix J requirements are estimated to be \$1.89 million for each ILRT and \$165 thousand for each LLRT. Reducing the frequency with which ILRTs and LLRTs must be performed will, obviously, reduce the number of tests that will have to be performed over the operating life of the reactor. For ILRTs, this is a simple yes/no decision: either the test will be conducted or it will not be conducted.

For LLRTs, changing to a performance-based standard which requires testing of "lower-reliability penetrations" only on the current at-least-once-every-two-year schedule is estimated to reduce the number of components tested by at least 50 percent. The exact percentage will depend upon the specific frequency criteria adopted (see Appendix A) and, more importantly, the actual performance

histories of the components. To illustrate the potential cost savings, we have assumed that no Type B electrical penetrations and 50 percent of Type C valves would be classified as "lower reliability penetrations."

Elimination of Type B electrical penetrations from the current 2-year frequency requirement is estimated to eliminate \$25,000 (15 percent) of the current costs (\$165,000) for a complete battery of Type B/C tests. The relatively small cost reduction is because Type B penetrations, while numerous, are comparatively easy to test. Elimination of 50 percent of the Type C tests is estimated to reduce costs by an additional \$70,000. Thus, adoption of performance-based test frequencies is estimated to reduce the costs of Type B/C testing by about 58 percent.

8.2.5 Estimates of Baseline and Alternative Costs

Types A and B/C Tests

The alternatives considered in this analysis are defined in Section 6.4. Table 8-1 presents the estimates of remaining Appendix J costs per reactor for both 5 percent and 10 percent discount rates. Total costs for the industry are estimated to be \$724 million at a 5 percent discount rate and \$494 million at a 10 percent discount rate.

To evaluate the impact of license extension, the assumed testing schedule was extended to cover an additional 20 years of operation (Power Cycles 25 through 36). Table 8-2 presents the estimates of remaining Appendix J costs per reactor of the current Appendix J frequency and acceptance criteria assuming a 20-year license extension. Total costs, assuming all licensees seek and are granted a 20-year license extension, are estimated to be \$1,075 million at a 5 percent discount rate and \$599 million at a 10 percent discount rate.

Costs of the alternatives are estimated by making appropriate modifications (cost per test and/or frequency of tests) to the 20-year and 40-year

baseline estimates. Details of each estimate are presented in Appendix D, and the results on an industry-wide basis are summarized in Tables 8-3 through 8-6.

Alternative 1: Alternative 1, which maintains the current Appendix J frequency requirements but relaxes the acceptance criteria, is estimated to reduce the industry's 20-year baseline costs by \$73 million (10 percent) at a 5 percent discount rate and \$49 million (10 percent) at a 10 percent discount rate. For the 40-year baseline, this alternative reduces costs by \$108 million (10.1 percent) at a 5 percent discount rate and \$60 million (10 percent) at a 10 percent discount rate.

Alternative 2: This alternative which maintains the current Appendix J acceptance criteria but reduces the ILRT frequency from three per 10 years to two per 10 years, is estimated to reduce the industry's 20-year baseline costs by \$241 million (33.3 percent) at a 5 percent discount rate and \$168 million (34.1 percent) at a 10 percent discount rate. For the 40-year baseline, this alternative reduces costs by \$332 million (30.9 percent) at a 5 percent discount rate and \$194 million (32.3 percent) at a 10 percent discount rate.

Alternative 3: Alternative 3, which relaxes the current Appendix J acceptance criteria and reduces the ILRT frequency from three per 10 years to two per 10 years, is estimated to reduce the industry's 20-year baseline costs by \$287 million (39.7 percent) at a 5 percent discount rate and \$199 million (40.3 percent) at a 10 percent discount rate. For the 40-year baseline, this alternative reduces costs by \$404 million (37.5 percent) at a 5 percent discount rate and \$232 million (38.8 percent) at a 10 percent discount rate.

Alternative 4: Alternative 4, which maintains the current Appendix J acceptance criteria but reduces the ILRT frequency from three per 10 years to one per 10 years, is estimated to reduce the industry's 20-year baseline costs by \$481 million (66.4 percent) at a 5 percent discount

rate and \$333 million (67.4 percent) at a 10 percent discount rate. For the 40-year baseline, this alternative reduces costs by \$662 million (61.6 percent) at a 5 percent discount rate and \$383 million (63.9 percent) at a 10 percent discount rate.

Alternative 5: This alternative, which relaxes the current Appendix J acceptance criteria and reduces the ILRT frequency from three per 10 years to one per 10 years, is estimated to reduce the industry's 20-year baseline costs by \$500 million (69.1 percent) at a 5 percent discount rate and \$345 million (69.9 percent) at a 10 percent discount rate. For the 40-year baseline, this alternative reduces costs by \$697 million (64.8 percent) at a 5 percent discount rate and \$400 million (66.8 percent) at a 10 percent discount rate.

Alternative 6: Alternative 6, which maintains the current Appendix J acceptance criteria but reduces the ILRT frequency from three per 10 years to one per 20 years, is estimated to reduce the industry's 20-year baseline costs by \$597 million (82.5 percent) at a 5 percent discount rate and \$406 million (82.3 percent) at a 10 percent discount rate. For the 40-year baseline, this alternative reduces costs by \$823 million (76.5 percent) at a 5 percent discount rate and \$467 million (78 percent) at a 10 percent discount rate.

Alternative 7: Alternative 7, which relaxes the current Appendix J acceptance criteria and reduces the ILRT frequency from three per 10 years to one per 20 years, is estimated to reduce the industry's 20-year baseline costs by \$604 million (83.4 percent) at a 5 percent discount rate and \$411 million (83.1 percent) at a 10 percent discount rate. For the 40-year baseline, this alternative reduces costs by \$839 million (78.1 percent) at a 5 percent discount rate and \$475 million (79.4 percent) at a 10 percent discount rate.

Alternative 8: Alternative 8, which maintains the current Appendix J acceptance criteria and the ILRT frequency of three per 10 years but

Cost

relaxes LLRTs to "lower-reliability" penetrations only during refueling outages, is estimated to reduce the industry's 20-year baseline costs by \$40 million (5.5 percent) at a 5 percent discount rate and \$28 million (5.7 percent) at a 10 percent discount rate. For the 40-year baseline, this alternative reduces costs by \$55 million (5.1 percent) at a 5 percent discount rate and \$33 million (5.4 percent) at a 10 percent discount rate.

Alternative 9: Alternative 9, which relaxes the current Appendix J acceptance criteria, maintains the ILRT frequency at three per 10 years, but relaxes LLRTs to "lower-reliability" penetrations only during refueling outages, is estimated to reduce the industry's 20-year baseline costs by \$111 million (15.3 percent) at a 5 percent discount rate and \$76 million (15.4 percent) at a 10 percent discount rate. For the 40-year baseline, this alternative reduces costs by \$161 million (14.9 percent) at a 5 percent discount rate and \$91 million (15.1 percent) at a 10 percent discount rate.

Alternative 10: Alternative 10 which maintains the current Appendix J acceptance criteria, reduces the ILRT frequency to two per 10 years, and relaxes LLRTs to "lower-reliability" penetrations only during refueling outages, is estimated to reduce the industry's 20-year baseline costs by \$295 million (40.7 percent) at a 5 percent discount rate and \$206 million (41.7 percent) at a 10 percent discount rate. For the 40-year baseline, this alternative reduces costs by \$406 million (37.7 percent) at a 5 percent discount rate and \$237 million (39.5 percent) at a 10 percent discount rate.

Alternative 11: Alternative 11, which relaxes the current Appendix J acceptance criteria, reduces the ILRT frequency to two per 10 years, and reduces LLRTs to "lower-reliability" penetrations only during refueling outages, is estimated to reduce the industry's 20-year baseline costs by \$338 million (46.6 percent) at a 5 percent discount rate and \$235 million (47.5 percent) at a 10 percent discount rate. For the 40-year baseline, this alternative reduces costs

by \$473 million (44 percent) at a 5 percent discount rate and \$273 million (45.6 percent) at a 10 percent discount rate.

Alternative 12: Alternative 12, which maintains the current Appendix J acceptance criteria, reduces the ILRT frequency to one per 10 years, and relaxes LLRTs to "lower-reliability" penetrations only during refueling outages, is estimated to reduce the industry's 20-year baseline costs by \$548 million (75.6 percent) at a 5 percent discount rate and \$379 million (76.8 percent) at a 10 percent discount rate. For the 40-year baseline, this alternative reduces costs by \$754 million (70.1 percent) at a 5 percent discount rate and \$436 million (72.8 percent) at a 10 percent discount rate.

Alternative 13: Alternative 13, which relaxes the current Appendix J acceptance criteria, reduces the ILRT frequency to one per 10 years, and reduces LLRTs to "lower-reliability" penetrations only during refueling outages, is estimated to reduce the industry's 20-year baseline costs by \$563 million (77.8 percent) at a 5 percent discount rate and \$389 million (78.8 percent) at a 10 percent discount rate. For the 40-year baseline, this alternative reduces costs by \$784 million (72.9 percent) at a 5 percent discount rate and \$451 million (75.2 percent) at a 10 percent discount rate.

Alternative 14: Alternative 14, which maintains the current Appendix J acceptance criteria, reduces the ILRT frequency to one per 20 years, and relaxes LLRTs to "lower-reliability" penetrations only during refueling outages, is estimated to reduce the industry's 20-year baseline costs by \$670 million (92.6 percent) at a 5 percent discount rate and \$457 million (92.5 percent) at a 10 percent discount rate. For the 40-year baseline, this alternative reduces costs by \$923 million (85.8 percent) at a 5 percent discount rate and \$525 million (87.7 percent) at a 10 percent discount rate.

Alternative 15: Alternative 15, which relaxes the current Appendix J acceptance criteria, reduces the ILRT frequency to one per 20

years, and relaxes LLRTs to "lower-reliability" penetrations only during refueling outages, is estimated to reduce the industry's 20-year baseline costs by \$673 million (92.9 percent) at a 5 percent discount rate and \$458 million (92.8 percent) at a 10 percent discount rate. For the 40-year baseline, this alternative reduces costs by \$934 million (86.9 percent) at a 5 percent discount rate and discount rate.

On-Line Monitoring

Information provided by the Swedes and the French indicate that the OLM systems that they are familiar with, or in the case of the French using, cost about \$240 to \$400 thousand. These estimates are for an installed system, and no

breakdown of costs (e.g., engineering, instrumentation, installation) is available. Operating costs are considered to be insignificant, and the equipment is expected to have an operating life equal to that of the reactor itself.

As there do not appear to be any significant annual costs for operating or maintaining OLM systems, and because the service life of such systems are essentially the same as for the reactor itself, there is no need to perform a present worth evaluation of OLM costs. The cost of an OLM system is simply the initial installed cost, or approximately \$240 to \$400 thousand.

Table 8-1. Baseline (Per Reactor): 20-Year Test Cycle
No License Extensions, Current Appendix J Requirements

		Tests	Costs	Costs
		Required	5% Discount	10% Discount
Type B & C Tests (LLRTs) =			\$165,000 per test	
Type A Tests (ILRTs) =			\$1,890,000 per test	
Period	Duration	Tests	Costs	Costs
			5% Discount	10% Discount
13th Power Cycle	0 - 18 months			
13th Outage	18 - 20 months	B & C	153,353	143,017
14th Power Cycle	20 - 38 months			
14th Outage	38 - 40 months	A + B & C	1,619,377	1,397,561
15th Power Cycle	40 - 58 months			
15th Outage	58 - 60 months	B & C	130,331	104,087
16th Power Cycle	60 - 78 months			
16th Outage	78 - 80 months	A + B & C	1,376,264	1,017,139
17th Power Cycle	80 - 98 months			
17th Outage	98 - 100 months	B & C	110,765	75,754
18th Power Cycle	100 - 118 months			
18th Outage	118 - 120 months	A + B & C	1,169,649	740,270
19th Power Cycle	120 - 138 months			
19th Outage	138 - 140 months	B & C	94,136	55,134
20th Power Cycle	140 - 158 months			
20th Outage	158 - 160 months	A + B & C	994,053	538,765
21st Power Cycle	160 - 178 months			
21st Outage	178 - 180 months	B & C	80,003	40,126
22nd Power Cycle	180 - 198 months			
22nd Outage	198 - 200 months	A + B & C	844,818	392,111
23rd Power Cycle	200 - 218 months			
23rd Outage	218 - 220 months	B & C	67,993	29,204
24th Power Cycle	218 - 238 months			
Shutdown	238 - 240 months	none	0	0
Total Net Present Values			6,640,742	4,533,168

Table 8-2. Baseline (Per Reactor): 40-Year Test Cycle
20-Year License Extensions, Current Appendix J Requirements

Type B & C Tests (LLRTs) = \$165,000 per test
Type A Tests (ILRTs) = \$1,890,000 per test

Period	Duration	Tests Required	Costs	
			5% Discount	10% Discount
13th Power Cycle	0 - 18 months			
13th Outage	18 - 20 months	B & C	153,353	143,017
14th Power Cycle	20 - 38 months			
14th Outage	38 - 40 months	A + B & C	1,619,377	1,397,561
15th Power Cycle	40 - 58 months			
15th Outage	58 - 60 months	B & C	130,331	104,087
16th Power Cycle	60 - 78 months			
16th Outage	78 - 80 months	A + B & C	1,376,264	1,017,139
17th Power Cycle	80 - 98 months			
17th Outage	98 - 100 months	B & C	110,765	75,754
18th Power Cycle	100 - 118 months			
18th Outage	118 - 120 months	A + B & C	1,169,649	740,270
19th Power Cycle	120 - 138 months			
19th Outage	138 - 140 months	B & C	94,136	55,134
20th Power Cycle	140 - 158 months			
20th Outage	158 - 160 months	A + B & C	994,053	538,765
21st Power Cycle	160 - 178 months			
21st Outage	178 - 180 months	B & C	80,003	40,126
22nd Power Cycle	180 - 198 months			
22nd Outage	198 - 200 months	A + B & C	844,818	392,111
23rd Power Cycle	200 - 218 months			
23rd Outage	218 - 220 months	B & C	67,993	29,204
24th Power Cycle	218 - 238 months			
24th Outage	238 - 240 months	A + B & C	717,988	285,377
25th Power Cycle	240 - 258 months			
25th Outage	258 - 260 months	B & C	57,785	21,254
26th Power Cycle	260 - 278 months			
26th Outage	278 - 280 months	A + B & C	610,198	207,696
27th Power Cycle	280 - 298 months			
27th Outage	298 - 300 months	B & C	49,110	15,469
28th Power Cycle	300 - 318 months			
28th Outage	318 - 320 months	A + B & C	518,591	151,160
29th Power Cycle	320 - 338 months			
29th Outage	338 - 340 months	B & C	41,737	11,258
30th Power Cycle	340 - 358 months			
30th Outage	358 - 360 months	A + B & C	440,736	110,014
31st Power Cycle	360 - 378 months			
31st Outage	378 - 380 months	B & C	35,471	8,194
32nd Power Cycle	380 - 398 months			
32nd Outage	398 - 400 months	A + B & C	374,570	80,068
33rd Power Cycle	400 - 418 months			
33rd Outage	418 - 420 months	B & C	30,146	5,963
34th Power Cycle	420 - 438 months			
34th Outage	438 - 440 months	A + B & C	318,336	58,273
35th Power Cycle	440 - 458 months			
35th Outage	458 - 460 months	B & C	25,620	4,340
36th Power Cycle	460 - 478 months			
Shutdown	478 - 480 months	none	0	0
Total Net Present Values			9,861,030	5,492,234

Table 8-3. Summary of Industry-Wide Costs - 20-Year Baseline and Alternatives, 5-percent Discount

Percentage Alternative	Costs	Cost	
		Savings	Savings
Baseline - Current Leakage Criteria and Test Frequencies	724,000,000	0	0.0%
Alternative 1 - Relax Leakage Criteria Only	651,000,000	73,000,000	10.0%
Alternative 2 - Current Leakage Criteria, Change ILRT Frequency Only to 2 per 10 Years	483,000,000	241,000,000	33.3%
Alternative 3 - Relax Leakage Criteria, Change Frequency per Alternative 2	437,000,000	287,000,000	39.7%
Alternative 4 - Current Leakage Criteria, Change ILRT Frequency Only to 1 per 10 Years	243,000,000	481,000,000	66.4%
Alternative 5 - Relax Leakage Criteria, Change Frequency per Alternative 4	224,000,000	500,000,000	69.1%
Alternative 6 - Current Leakage Criteria, Change ILRT Frequency Only to 1 per 20 Years	127,000,000	597,000,000	82.5%
Alternative 7 - Relax Leakage Criteria, Change Frequency per Alternative 6	120,000,000	604,000,000	83.4%
Alternative 8 - Current Leakage Criteria, "Lower-Reliability" LLRTs Only During Refueling	684,000,000	40,000,000	5.5%
Alternative 9 - Relaxed Leakage Criteria, "Lower-Reliability" LLRTs Only During Refueling	613,000,000	111,000,000	15.3%
Alternative 10 - Current Leakage Criteria, Change Frequency of ILRTs to 2 in 10 Years, "Lower-Reliability" LLRTs Only During Refueling	429,000,000	295,000,000	40.7%
Alternative 11 - Relaxed Leakage Criteria, Change Frequency per Alternative 10	386,000,000	338,000,000	46.6%
Alternative 12 - Current Leakage Criteria, Change Frequency of ILRTs to 1 in 10 Years, "Lower-Reliability" LLRTs Only During Refueling	176,000,000	548,000,000	75.6%
Alternative 13 - Relaxed Leakage Criteria, Change Frequency per Alternative 12	161,000,000	563,000,000	77.8%
Alternative 14 - Current Leakage Criteria, Change Frequency of ILRTs to 1 in 20 Years, "Lower-Reliability" LLRTs Only During Refueling	54,000,000	670,000,000	92.6%
Alternative 15 - Relaxed Leakage Criteria, Change Frequency per Alternative 14	51,000,000	673,000,000	92.9%

Table 8-4. Summary of Industry-Wide Costs - 20-year Baseline and Alternatives, 10-percent Discount

Alternative	Costs	Cost Savings	Percentage Savings
Baseline - Current Leakage Criteria and Test Frequencies	494,000,000	0	0.0%
Alternative 1 - Relax Leakage Criteria Only	445,000,000	49,000,000	10.0%
Alternative 2 - Current Leakage Criteria, Change ILRT Frequency Only to 2 per 10 Years	326,000,000	168,000,000	34.1%
Alternative 3 - Relax Leakage Criteria, Change Frequency per Alternative 2	295,000,000	199,000,000	40.3%
Alternative 4 - Current Leakage Criteria, Change ILRT Frequency Only to 1 per 10 Years	161,000,000	333,000,000	67.4%
Alternative 5 - Relax Leakage Criteria, Change Frequency per Alternative 4	149,000,000	345,000,000	69.9%
Alternative 6 - Current Leakage Criteria, Change ILRT Frequency Only to 1 per 20 Years	88,000,000	406,000,000	82.3%
Alternative 7 - Relax Leakage Criteria, Change Frequency per Alternative 6	83,000,000	411,000,000	83.1%
Alternative 8 - Current Leakage Criteria, "Lower-Reliability" LLRTs Only During Refueling	466,000,000	28,000,000	5.7%
Alternative 9 - Relaxed Leakage Criteria, "Lower-Reliability" LLRTs Only During Refueling	418,000,000	76,000,000	15.4%
Alternative 10 - Current Leakage Criteria, Change Frequency of ILRTs to 2 in 10 Years, "Lower-Reliability" LLRTs Only During Refueling	288,000,000	206,000,000	41.7%
Alternative 11 - Relaxed Leakage Criteria, Change Frequency per Alternative 10	259,000,000	235,000,000	47.5%
Alternative 12 - Current Leakage Criteria, Change Frequency of ILRTs to 1 in 10 Years, "Lower-Reliability" LLRTs Only During Refueling	115,000,000	379,000,000	76.8%
Alternative 13 - Relaxed Leakage Criteria, Change Frequency per Alternative 12	105,000,000	389,000,000	78.8%
Alternative 14 - Current Leakage Criteria, Change Frequency of ILRTs to 1 in 20 Years, "Lower-Reliability" LLRTs Only During Refueling	37,000,000	457,000,000	92.5%
Alternative 15 - Relaxed Leakage Criteria, Change Frequency per Alternative 14	36,000,000	458,000,000	92.8%

Table 8-5. Summary of Industry-Wide Costs - 40-year Baseline and Alternatives, 5-percent Discount

Percentage Alternative	Costs	Cost	
		Savings	Savings
Baseline - Current Leakage Criteria and Test Frequencies	1,075,000,000	0	0.0%
Alternative 1 - Relax Leakage Criteria Only	967,000,000	108,000,000	10.1%
Alternative 2 - Current Leakage Criteria, Change ILRT Frequency Only to 2 per 10 Years	743,000,000	332,000,000	30.9%
Alternative 3 - Relax Leakage Criteria, Change Frequency per Alternative 2	671,000,000	404,000,000	37.5%
Alternative 4 - Current Leakage Criteria, Change ILRT Frequency Only to 1 per 10 Years	413,000,000	662,000,000	61.6%
Alternative 5 - Relax Leakage Criteria, Change Frequency per Alternative 4	378,000,000	697,000,000	64.8%
Alternative 6 - Current Leakage Criteria, Change ILRT Frequency Only to 1 per 20 Years	252,000,000	823,000,000	76.5%
Alternative 7 - Relax Leakage Criteria, Change Frequency per Alternative 6	236,000,000	839,000,000	78.1%
Alternative 8 - Current Leakage Criteria, "Lower-Reliability" LLRTs Only During Refueling	1,020,000,000	55,000,000	5.1%
Alternative 9 - Relaxed Leakage Criteria, "Lower-Reliability" LLRTs Only During Refueling	914,000,000	161,000,000	14.9%
Alternative 10 - Current Leakage Criteria, Change Frequency of ILRTs to 2 in 10 Years, "Lower-Reliability" LLRTs Only During Refueling	669,000,000	406,000,000	37.7%
Alternative 11 - Relaxed Leakage Criteria, Change Frequency per Alternative 10	602,000,000	473,000,000	44.0%
Alternative 12 - Current Leakage Criteria, Change Frequency of ILRTs to 1 in 10 Years, "Lower-Reliability" LLRTs Only During Refueling	321,000,000	754,000,000	70.1%
Alternative 13 - Relaxed Leakage Criteria, Change Frequency per Alternative 12	291,000,000	784,000,000	72.9%
Alternative 14 - Current Leakage Criteria, Change Frequency of ILRTs to 1 in 20 Years, "Lower-Reliability" LLRTs Only During Refueling	152,000,000	923,000,000	85.8%
Alternative 15 - Relaxed Leakage Criteria, Change Frequency per Alternative 14	141,000,000	934,000,000	86.9%

Table 8-6. Summary of Industry-Wide Costs - 40-year Baseline and Alternatives, 10-percent Discount

Alternative	Costs	Cost Savings	Percentage Savings
Baseline - Current Leakage Criteria and Test Frequencies	599,000,000	0	0.0%
Alternative 1 - Relax Leakage Criteria Only	539,000,000	60,000,000	10.0%
Alternative 2 - Current Leakage Criteria, Change ILRT Frequency Only to 2 per 10 Years	405,000,000	194,000,000	32.3%
Alternative 3 - Relax Leakage Criteria, Change Frequency per Alternative 2	367,000,000	232,000,000	38.8%
Alternative 4 - Current Leakage Criteria, Change ILRT Frequency Only to 1 per 10 Years	216,000,000	383,000,000	63.9%
Alternative 5 - Relax Leakage Criteria, Change Frequency per Alternative 4	199,000,000	400,000,000	66.8%
Alternative 6 - Current Leakage Criteria, Change ILRT Frequency Only to 1 per 20 Years	132,000,000	467,000,000	78.0%
Alternative 7 - Relax Leakage Criteria, Change Frequency per Alternative 6	124,000,000	475,000,000	79.4%
Alternative 8 - Current Leakage Criteria, "Lower-Reliability" LLRTs Only During Refueling	566,000,000	33,000,000	5.4%
Alternative 9 - Relaxed Leakage Criteria, "Lower-Reliability" LLRTs Only During Refueling	508,000,000	91,000,000	15.1%
Alternative 10 - Current Leakage Criteria, Change Frequency of ILRTs to 2 in 10 Years, "Lower-Reliability" LLRTs Only During Refueling	362,000,000	237,000,000	39.5%
Alternative 11 - Relaxed Leakage Criteria, Change Frequency per Alternative 10	326,000,000	273,000,000	45.6%
Alternative 12 - Current Leakage Criteria, Change Frequency of ILRTs to 1 in 10 Years, "Lower-Reliability" LLRTs Only During Refueling	163,000,000	436,000,000	72.8%
Alternative 13 - Relaxed Leakage Criteria, Change Frequency per Alternative 12	148,000,000	451,000,000	75.2%
Alternative 14 - Current Leakage Criteria, Change Frequency of ILRTs to 1 in 20 Years, "Lower-Reliability" LLRTs Only During Refueling	74,000,000	525,000,000	87.7%
Alternative 15 - Relaxed Leakage Criteria, Change Frequency per Alternative 14	69,000,000	530,000,000	88.5%

9. UNCERTAINTIES

9.1 UNCERTAINTIES IN RISK PERSPECTIVE

Figure 5-22 (taken directly from NUREG-1150 [NRC90]) illustrates the uncertainty range associated with the predicted total latent cancer fatalities per reactor year. For Surry, the 5 - 95 percent confidence interval spans approximately two orders of magnitude (from about $3E-4$ to about $2E-2$ latent cancer fatalities per year). Comparable ranges of uncertainty are found for the other units considered.

Containment leakage, at an assumed rate of 1 percent per day, contributes about 0.05 percent to the total risk at Surry; comparable or even smaller leakage contributions to risk were found for the other units. Since the design basis leakage rate for Surry is 0.1 percent per day, the reference risk results already include an order of magnitude "allowance" for increased leakage; comparable increases above the design basis leakage rates were incorporated into the assessments for the other units.

Since containment leakage is such a small contributor to overall accident risk, it is clear that at the lower end of the leakage-rate ranges considered in this study, any uncertainties associated with the leakage contribution are minuscule in comparison with other uncertainties, e.g., prediction of containment failure mode probabilities and magnitudes of fission product source terms. The NUREG-1150 results for PWRs predict significant probabilities of no containment failure even in the event of core melt accidents. With the containments predicted to remain intact, at the upper end of the leakage-rate ranges considered, i.e., 200 - 400 percent containment volume per day, containment leakage could lead to several-fold increases in the predicted risk. The expected fission product source terms associated with the large leakage-rate cases, considering all possible unit damage states and accident progression bins, were substantially lower than those resulting from containment failure or bypass. Thus, the uncertainties associated with

assessing the leakage contribution at the upper ends of the ranges considered would be lower than those associated with other containment failure modes.

For BWRs, the calculated risks were found to be very insensitive to the assumed containment leakage rates, even at the upper end of the ranges considered. This is a direct consequence of predicted higher probabilities of early containment failure for the BWRs, i.e., since containments are predicted to fail in a large fraction of the postulated core melt accidents, the assumed containment leakage rate does not contribute significantly to the calculated risk. Also, the scrubbing of the fission products by BWR suppression pools, even in many scenarios involving large leakages, contributes to the predicted lack of risk sensitivity to containment leakage rate. Thus, for BWRs, the uncertainties associated with assessing the contribution of containment leakage are small compared with other uncertainties in the quantification of accident risks.

The estimate of the fraction of containment leaks that can be found only by integrated leakage-rate testing is uncertain due to the small number of such occurrences. The rarity of such events demonstrates that reactor containments do in fact achieve a high degree of reliability and leak-tightness. The present study found that about 3 percent of observed containment leaks could be found only by integrated leakage-rate testing. In the few such occurrences identified in this study, the associated leakage rates were only marginally above existing requirements, ranging from only slightly above $0.75 L_a$ to about three L_a .

At such low levels, the containment leakage rates are clearly not significant contributors to reactor accident risks, as demonstrated in Chapter 5. However, since containment penetrations may range in size from a diameter of about 0.25 inches for sampling lines to over 10 feet for the equipment hatch, leakage through the latter cannot be ignored. The simultaneous

Uncertainties

failure of redundant 36-inch purge valves, for example, would be functionally equivalent to containment failure. Of course, the simultaneous failure of two valves in a large containment penetration would be of much lower probability than a random combination of coincident smaller leakage paths. The experience-based best estimate of the magnitude of undetected containment leakages indicates that they would not be risk significant. However, because not all leakage-test failures are fully quantified and because there have been a few prolonged containment isolation failures, considerable uncertainty must be acknowledged in the possible magnitude of undetected containment leakages.

While the consequences of large leakage paths existing at the time of a core melt accident may be functionally equivalent to containment failure, such large leakages are very unlikely. Thus, the risk impact would be limited.

Assigning an average core melt consequence to the fraction of the time that the magnitude of the containment leakage rate may be uncertain led to an insignificant impact (~0.1 percent) on the nominal risk. The use of an average consequence takes into account the possibility that the unquantified leakages could range from leakage rates just exceeding the allowable to very large openings. This is preferable to alternatives such as assuming that all unquantified leakages are equivalent to gross containment failure.

Applying the average-consequence approach to the various testing alternatives considered in Chapter 7 resulted in maximum risk increases of about 26 percent over the base cases calculated in NUREG-1150. As indicated in Chapter 7, for the nominal case, a maximum risk impact of about 6 percent was calculated.

9.2 UNCERTAINTIES IN COST PERSPECTIVE

The results presented are derived from limited cost data provided by industry and an evaluation of the activities required to conduct the various types of leakage testing. The value of \$1.89 million per ILRT given for the current leakage-rate criteria is, due to the dominance of replacement power costs, the most certain of the estimates presented. NUMARC found the total cost per ILRT to be in the range of \$0.68 to \$9.9 million, with an average of \$1.8 million. As in the present study, NUMARC estimated costs are dominated by critical path energy replacement cost. The value of \$165 thousand for a fully battery of Type B & C tests is based on limited data from two utilities and an analysis of the labor costs associated with testing a typical Type C penetration. The value used is bounded by the estimates provided by industry. The value of \$70 thousand used only for "lower reliability" LLRTs illustrate the cost savings that might be achievable under a performance based rule. As noted in Chapter 8, the actual cost savings will depend upon the criteria imposed and each unit's specific performance history.

10. Summary of Technical Findings

This section summarizes the technical work in support of the information needs of the NRC's rulemaking. The NRC's Regulatory Analysis will consider other non-technical factors and perform the cost-benefit analyses necessary prior to decision making.

This TSD contributes to the technical bases for revising the NRC's 10 *CFR* Part 50, Appendix J, requirements considered by the NRC to be marginal to safety. Specifically, this TSD evaluates risks and costs associated with alternative performance-based containment leakage-testing requirements. Performance-based requirements are those whose limits are based upon consideration of operating history and risk insights.

Alternatives considered in this TSD are longer intervals between containment leak tests, and an increase in the allowable leakage rate from the containment structure. In addition, an alternative requiring continuous on-line monitoring of containment integrity is considered.

10.1 RISK

With respect to public and worker risk, the key technical issue a revised Appendix J regulation must address is "Can revised containment leakage-testing requirements have only a marginal impact on safety comparable to the level of safety achieved by current 10 *CFR* Part 50, Appendix J requirements?"

The following paragraphs summarize the findings of the technical analysis under the headings Significance of Containment Leakage Rates, Leakage-Test Intervals, Allowable Leakage Rate, and On-Line Monitoring Systems. Table 10-1 provides a summary of the risk impact for the various alternatives considered.

10.1.1 Significance of Containment Leakage Rates

Past studies, such as those summarized in Figure 5-1, have shown that overall population risks from severe reactor accidents are not very sensitive to the assumed containment leakage rates. This is because predicted reactor risks are dominated by accident scenarios in which the containments are predicted to fail or in which the containments are bypassed. The earlier studies were based on the risk insights from WASH-1400 (NRC75) and related studies.

The results of the present effort, which are based on NUREG-1150 (NRC90), while quantitatively different from earlier studies, confirm the previous observations of insensitivity of population risks from severe reactor accidents to containment leakage rates. The differences between the earlier results and those of this study are due to different approaches, increased understanding of severe accident phenomenology, and significant advances in the state-of-the-art in probabilistic risk assessment.

The present effort includes comparisons of the predicted reactor accident risks as a function of containment leakage rate with the NRC's safety goals. As shown in Figure 7-2, the calculated risks are well below the safety goal for all of the reactors considered even at assumed containment leakage rates several orders of magnitude above current requirements.

10.1.2 Leakage-Testing Intervals

Type A (ILRT) Test Interval

1. Reducing the frequency of Type A tests (ILRTs) from the current three per 10 years to one per 20 years was found to lead to an imperceptible increase in risk. The estimated increase in risk is very small

Table 10-1. Summary of Risk Impacts of Alternatives

Alt	Frequency				Leakage Rate		Change in Risk* (Person-Rem)	
	No Change		Relax		No Change	Relax	Public	Worker
	A	B/C	A (Tests per X Years)	B/C				
1	X	X				X	0.18	-
2		X	2/10		X		0.04	(0.8)
3		X	2/10			X	0.22	(0.8)
4		X	1/10		X		0.04	(1.6)
5		X	1/10			X	0.22	(1.6)
6		X	1/20		X		0.05	(2.0)
7		X	1/20			X	0.23	(2.0)
8	X			X	X		0.69	(7.2)
9	X			X		X	0.87	(7.2)
10			2/10	X	X		0.73	(10.4)
11			2/10	X		X	0.91	(10.4)
12			1/10	X	X		0.73	(13.6)
13			1/10	X		X	0.91	(13.6)
14			1/20	X	X		0.73	(15.2)
15			1/20	X		X	0.91	(15.2)

* Based on the Surry unit; 20-year remaining life. Numbers in parenthesis indicate a risk reduction.

because ILRTs identify only a few potential containment leakage paths that cannot be identified by Type B and C testing, and the leaks that have been found by Type A tests have been only marginally above existing requirements.

The impact of relaxing the ILRT frequency beyond one in 20 years has not been evaluated. Beyond testing the performance of containment penetrations, ILRTs also test the integrity of the containment structure.

Type B & C (LLRT) Test Intervals

- Given the insensitivity of risk to containment leakage rate (Chapter 5) and the small fraction of leakage paths detected solely by Type A testing, increasing the interval between integrated leakage-rate tests is possible with minimal impact on public risk.

- Type B and C tests can identify the vast majority (greater than 95 percent) of all potential leakage paths.

2. Reducing the frequency of Type B testing of electrical penetrations should be possible with no adverse impact on risk. An assessment of Type B testing of electrical penetrations at a single station (two operating units) indicates that leaks through these penetrations are both infrequent and small (on the order of 1 percent of the total allowable leakage rate). Similar experience is reported in the Grand Gulf Appendix J exemption request as well as in the NUMARC survey of containment leakage-testing experience.
3. The vast majority of leakage paths are identified by LLRTs of containment isolation valves (Type C tests). Based on the detailed evaluation of the experience of a single two-unit station, almost no correlation of failures with type of valve or unit service could be found; however, it has been possible to correlate failures both with time and repeated failures of individual components. The results of the NUMARC survey of leakage-testing experience are consistent with these observations.
4. Based on the model of component failure with time, it has been found that performance-based alternatives to current local leakage-testing requirements are feasible without significant risk impacts. For example, the model suggests that the number of components tested could be reduced by about 60 percent with less than a three-fold increase in the incremental risk due to containment leakage. Since under existing requirements, leakage contributes less than 0.1 percent of overall accident risk, the overall impact is very small.

The findings to date strongly support earlier indications that Type B and C testing can detect a very large fraction of containment leaks. The fraction of leaks that can be detected only by integrated containment leakage tests is small, on the order of a few percent.

The discussion of leakage rate experience in Chapter 4 indicates that frequent Type B leakage-rate testing of electrical penetrations is of limited use. In approximately 27 unit-years of operation at one two-unit nuclear station, no significant leakage has been found for electrical penetrations.

10.1.3 Allowable Leakage Rate

1. The allowable leakage rate can be increased by one to two orders of magnitude without significantly impacting the estimates of population dose in the event of an accident. The PRA for Surry Unit 1, which was performed assuming a containment leakage rate a factor of 10 greater than the nominal 0.1 percent per day established in the unit's technical specifications, indicates that accident scenarios where containment does not fail and is not bypassed contribute only about 0.05 percent of the population risk from all core-melt accidents. Comparable or even lower risk contributions due to leakage were found for the other units.
2. The significance of any change in the risk to the nearby individuals, who would receive the highest doses from an accidental release, have not been evaluated explicitly. Within the ranges considered for relaxing the containment leakage rate, the increase in postulated accident consequences due to leakage would be proportional to the increase in the containment leakage rate.
3. The impact of increased leakage rates on routine airborne effluent releases has not been quantitatively assessed. Doses from current airborne releases have been evaluated by the EPA as resulting in doses of less than a few mrem per year (EPA91). As only about 10 percent of containment penetrations constitute a potential direct pathway to the environment during the normal operating mode, impacts, if any, are likely to be small.

Summary

10.1.4 On-Line Monitoring Systems

Ability to Detect Leaks

Continuous monitoring methods exist that appear technically capable of detecting leaks in reactor containments. While OLM does not have the accuracy of Type A testing, it does seem to offer enough accuracy and speed to detect gross leakage. OLM is capable of detecting leaks within one day to several weeks.

OLM can detect only gross containment leakage (NRC88). It cannot detect leaks through systems that do not normally communicate with the containment atmosphere. Gross leakages are most likely to occur from systems left open, such as air locks, purge/vent pathways, or similar direct air path system valves or penetrations, or from failures in isolation mechanisms in such systems.

OLM cannot be considered as a complete replacement for Type A tests since it cannot challenge the structural and leak-tight integrity of the containment system at elevated pressures.

Risk Considerations

OLM does not significantly reduce the risk to the public from nuclear unit operation and, thus, cannot be justified solely on risk considerations. As noted for the Surry unit, containment isolation failure has been found to contribute approximately 0.05 percent of the total latent accident risk. Given this low contribution and the limitations of on-line monitoring systems noted above, the potential risk benefit of on-line monitoring appears to be quite limited.

International Experience

Canadian, French and Belgian utilities have installed OLMs on their PWR units and monitored containment leakage during power operations. They reported that OLMs are capable of detecting leaks in the radiation monitoring system, nuclear island vent and drain

system, containment purge system, and containment atmosphere monitoring system.

Open Issues

The usefulness of OLM systems depends on the resolution of several issues requiring further research. Specifically, the following limitations are noted:

1. difficulty in accounting for the effect of temperature and moisture gradients and variations on the test results,
2. the possibility of an actual leak being masked by containment air/gas inleakage,
3. inability to account for leaks in closed pressurized systems inside containment that would probably not be measured during on-line monitoring,
4. potential "false alarms" from on-line monitoring, and
5. the need for stabilized conditions within the containment during reactor operation.

10.2 COST

With respect to cost, the key issue is "Can a revised containment testing rule, which has a marginal impact on safety, also significantly reduce the financial burden on utilities?"

The findings of the cost analysis are provided in the following paragraphs, and the industry-wide cost savings of the various alternatives are summarized in Table 10-2.

1. Costs of performing Type B and C tests are relatively insensitive to the allowable leakage rate. Only a small number of penetrations fail any given battery of tests, and the percentage of penetrations that marginally fail is even smaller. Thus, it is unlikely that any significant amount of repairs would be avoided regardless of the allowable leakage rate.

Summary

2. Costs of Type B and C tests are considerably less than those of Type A tests because they are not performed on the critical path.
3. Costs of Type A tests, which are performed on the critical path, are dominated by the cost of replacement power. Replacement power is estimated to account for almost 80 percent of the total costs of Type A testing. Increasing the allowable leakage rate is estimated to reduce the critical-path time required to conduct an ILRT by 16 hours and decrease the cost of an ILRT by about 10 percent.
4. Based on 20 years of operational life remaining for the average reactor and an 18-month refueling schedule, current test frequencies are estimated to have a net present cost of \$6.6 million per reactor at a 5 percent discount rate, and \$4.5 million per reactor at a 10 percent discount rate.
5. Assuming the same 20-year period and test frequencies as above, increasing the allowable leakage rate is estimated to reduce the remaining costs of leak testing by 10 percent.
6. Reducing the number of ILRTs from three per 10 years to one per 10 years is estimated to eliminate more than 66 percent of the remaining costs of leak testing. Testing on a one in 20-year interval would eliminate about 83 percent of remaining costs.
7. For illustrative purposes, it was assumed that 58 percent of the costs of LLRTs could be eliminated by a performance-based rule. Such a reduction would result in about a 6 percent reduction in the remaining costs of leak testing.
8. A rough estimate for OLM systems indicates that costs would be on the order of one-quarter of a million dollars. If OLM were an addition to existing requirements, this would represent approximately a 4 percent increase in testing costs.

Table 10-2. Summary of Industry-Wide Cost Savings

Alternative	Cost Savings (Millions of Dollars)			
	20-Year Test Cycle		40-Year Test Cycle	
	5% Discount	10% Discount	5% Discount	10% Discount
1	73	49	108	60
2	241	168	332	194
3	287	199	404	232
4	481	33	662	383
5	500	345	697	400
6	597	406	823	467
7	604	411	839	475
8	40	28	55	33
9	111	76	161	91
10	295	206	406	237
11	338	235	473	273
12	548	379	754	436
13	563	389	784	451
14	670	457	923	525
15	673	458	934	530

References

- AEC62 DiNunno, et al., "Calculations and Distance Factors for Power and Test Reactor Sites," TID-14844, U.S. Atomic Energy Commission, Washington, D.C., 1962.
- BEL86 "Report of the Working Group on Containment Leakage Testing," Belgium, April 15, 1986.
- BEL86A "De Boeck, B., "New Belgian Position on Containment Leakage Testing," Association Vincotte, Belgium, 1986. [Published in NUREG/CP-0076, "Proceedings of the Third Workshop on Containment Integrity," August 1986.]
- BMI86 Gieseke, J. A., Cybulskis, P., Denning, R. S., Kuhlman, M. R., Lee, K. W., Chen, H., Freeman-Kelly, R., Jordan, H., Curtis, L. A., Kogan, V., Schumacher, P. M., and Carlton, H. E., "Radionuclide Release Under Specific LWR Accident Conditions, Volume VIII, Additional Information," BMI-2104, July 1986.
- BN72 Bechtel National, Inc., BN-TOP-1, Revision 1, November 1972.
- BOE90 De Boeck, B., "Severe Accident Risk Reduction by Containment Leakage Testing during Operation," Nuclear Engineering and Design 120 (1990) 87-91, North-Holland.
- CAN94 Collins, N. and P. Lafreniere, "On-Line Reactor Building Integrity Testing at Gentilly-2 (Summary of Results 1987-1994)", Hydro-Quebec Gentilly-2 Nuclear Power Station, Canada, October 1994.
- EDF89 Germain, J.L. and Janneteau, "Continuous Monitoring of Containment Leaktightness - The SEXTEN System," EDF, Direction des Etudes et Recherches, France, March 1989.
- EDF93 Pollier, R., "The SEXTEN System - Continuous Monitoring of Containment Leaktightness," EDF, Energy and Mechanics Department, France, September 1993.
- EPA91 U.S. Environmental Protection Agency, "Background Information Document to Support NESHAPS Rulemaking On Nuclear Power Reactors," EPA520/1-91-019, Draft, August 1991.
- EPRI83 Electric Power Research Institute, Project 1393-5, EPRI NP-3400, Final Report, December 1983.
- EPRI94 Erin Engineering and Research, Inc. for Electric Power Research Institute, "Shutdown Risk Impact Assessment for Extended Containment Leakage Testing Interval Utilizing ORAM™", TR-105189, April 1994.
- GG93 Grand Gulf Nuclear Station, Docket No. 50-416, License No. NPF-29, "Application for Exemption from 10CFR50 Appendix J and Proposed Amendment to Operating License (PCOL-93/010)," August 13, 1993.

References

- GG94 Grand Gulf Nuclear Station, Docket No. 50-416, License No. NPF-29, "Weibull Analysis of Type C Test Data in Support of the GGNS Appendix J Submittal," June 1994.
- GIE90 Gieseke, J. A., Cybulskis, P., Jordan, H., Lee, K. W., Kuhlman, M. R., Wooton, R. O., Kogan, V., and Freeman-Kelly, R., "Source Term Code Package: A User's Guide (Mod 2)," February 28, 1990.
- NRC75 U.S. Nuclear Regulatory Commission, "Reactor Safety Study," WASH-1400, NUREG/75/014, Washington, D.C., 1975.
- NRC81 Kolb, G. J., Hatch, S. W., Cybulskis, P., and Wooton, R. O., "Reactor Safety Study Methodology Applications Program: Oconee #3 PWR Power Plant," NUREG/CR-1659/2 of 4, January 1981.
- NRC81A Hatch, S. W., Cybulskis, P., and Wooton, R. O., "Reactor Safety Study Methodology Applications Program: Grand Gulf #1 BWR Power Plant," NUREG/CR-1659/4 of 4, October 1981.
- NRC83 Ritchie, L.T., et al., "Calculations of Reactor Accident Consequences Version 2, CRAC2: Computer Code User's Guide," NUREG/CR-2326, 1983.
- NRC83A U.S. Nuclear Regulatory Commission, "Regulatory Analysis Guidelines of the U.S. Nuclear Regulatory Commission," NUREG/CR-0058, January 1983.
- NRC84 Ritchie, L.T., et al., "CRAC2 Model Description," NUREG/CR-2552, 1984.
- NRC84A Hermann, O.W. and T.J. Burns, "Impact of Containment Building Leakage on LWR Accident Risk," NUREG/CR-3539, Oak Ridge National Laboratory, Oak Ridge, Tennessee, 1984.
- NRC85 U.S. Nuclear Regulatory Commission, "Reliability Analysis of Containment Isolation Systems," NUREG/CR-4220, June 1985.
- NRC85A Bergeron, K. D., et al., "User's Manual for CONTAIN 1.0, A Computer Code for Severe Reactor Accident Containment Analysis," NUREG/CR-4085, July 1985.
- NRC86 Mullen, M. F., et al., "Review of Light Water Reactor Regulatory Requirements," Pacific Northwest Laboratory, NUREG/CR-4330, PNL-5809, Vol. 2, June 1986.
- NRC86A Code of Federal Regulations, Title 10, Part 100 (10CFR 100), "Reactor Site Criteria," Government Printing Office, Washington, D.C., 1986.
- NRC86B Code of Federal Regulations, Title 10, Part 50 (10CFR 50), "Domestic Licensing of Production and Utilization Facilities," Appendices: A, I, J, and K, 1986.

References

- NRC86C U.S. Nuclear Regulatory Commission, "Safety Goals for the Operations of Nuclear Power Plants; Policy Statement, Federal Register, Volume 51, No. 149, August 1986.
- NRC88 U.S. Nuclear Regulatory Commission, "Technical Findings and Regulatory Analysis for Generic Safety Issue II.E.4.3 - Containment Integrity Check," NUREG-1273, April 1988.
- NRC89 U.S. Nuclear Regulatory Commission, "Implementation of Safety Goal Policy," SECY-89-102, March 1989.
- NRC89A U.S. Nuclear Regulatory Commission, Commissioner Rogers, "Safety Goals - Where Do We Go From Here?," ANS Workshop on Reactor Safety Objectives and Criteria, Idaho Falls, Idaho, August 1989.
- NRC90 "Severe Accident Risks: An Assessment for Five U.S. Nuclear Power Plants, Final Summary Report," NUREG-1150, December 1990.
- NRC90A Ericson, D. M., Jr., et al., "Analysis of Core Damage Frequency: Internal Events Methodology," Sandia National Laboratories, NUREG/CR-4550, Vol. 1, Revision 1, SAND86-2084, January 1990.
- NRC90B Breeding, R.J., et al., "Evaluation of Severe Accident Risks: Surry Unit 1, Main Report," NUREG/CR-4551, SAND86-1309, Vol. 3, Rev. 1, Part 1, October 1990.
- NRC90C Payne, A.C., et al., "Evaluation of Severe Accident Risks: Peach Bottom, Unit 2, Main Report," NUREG/CR-4551, SAND86-1309, Vol. 4, Rev. 1, Part 1, December 1990.
- NRC90D Brown, T.D., et al., "Evaluation of Severe Accident Risks: Grand Gulf, Main Report," NUREG/CR-4551, SAND86-1309, Vol. 6, Rev. 1, Part 1, December 1990.
- NRC90E Gregory, J.J., et al., "Evaluation of Severe Accident Risks: Sequoyah Unit 1, Main Report," NUREG/CR-4551, SAND86-1309, Vol. 5, Rev. 1, Part 1, December 1990.
- NRC90F Park, C.K., et al., "Evaluation of Severe Accident Risks: Zion, Unit 1, Main Report," NUREG/CR-4551, BNL-NUREG-52029, Vol. 7, Rev. 1, Part 1, March 1993.
- NRC90G U.S. Nuclear Regulatory Commission, Memo Chilk to Taylor, "SECY-89-102 - Implementation of the Safety Goals," June 1990.
- NRC91 U.S. Nuclear Regulatory Commission, "Interim Guidance on Staff Implementation of the Commission's Safety Goal Policy," SECY-91-270, August 1991.
- NRC91A VanKuiken, J.C., et al., "Replacement Energy Costs for Nuclear Electricity-Generating Units in the United States: 1992 - 1996," NUREG/CR-4012, ANL-AA-30, Vol. 3.

References

- NRC92 U.S. Nuclear Regulatory Commission, "Elimination of Requirements Marginal to Safety," SECY-92-263, July 24, 1992.
- NRC93 U.S. Nuclear Regulatory Commission, Memo Heltemes to Larkins, "Staff Approach for Assessing the Consistency of the Present Regulations with respect to the Commission's Safety Goals," April 1993.
- NRC93B U.S. Nuclear Regulatory Commission, "Workshop on Program for Elimination of Requirements Marginal to Safety," NUREG/CP-0129, Bethesda, Maryland, April 1993.
- NRC93C U.S. Nuclear Regulatory Commission, "Trip Report for Meetings with Swedish Nuclear Power Inspectorate and Vattenfall Energisystem (Utility) to Discuss Approaches to Containment Testing," Memorandum to Distribution, M. Dey, September 23, 1993
- NRC94 U.S. Nuclear Regulatory Commission, "Codes and Standards for Nuclear Power Plants; Subsection IWE and Subsection IWL," Federal Register, Volume 59, No. 5, January 7, 1994.
- NRC94A U.S. Nuclear Regulatory Commission, "Trip Report for Meetings with Electricite de France, and Nuclear Industry Representatives in Belgium to Discuss Approaches to Containment Testing," Memorandum to Distribution, M. Dey, January 11, 1994
- NUM94 Letter from W. J. Hall, NUMARC, to M. Dey, NRC, dated February 18, 1994.
- PNL83 Battelle Pacific Northwest Laboratories, "Handbook for Value-Impact Assessment," NUREG/CR-3568, December 1983.
- SEA85 Science and Engineering Associates, Mathtech, S. Cohen & Associates, "Cost Analysis of Revisions to 10 CFR Part 50, Appendix J, Leak Tests for Primary and Secondary Containments of Light-Water-Cooled Nuclear Power Plants," NRC Contract 33-84-407, April 1985.
- SEPRI94 Seveon, J.J., "PWR's Containment Leaktightness - A Comparison of the French and American Approaches," SEPRI Report No. 18, September 1994.
- SNL91 Sandia National Laboratories, "MELCOR 1.8.1 Computer Code Manual," June 1991.

Glossary

Acceptance criteria - standards against which test results are to be compared for establishing the functional acceptability of the containment as a leakage-limiting boundary.¹

As found - leakage measured during an integrated leakage-rate test before any remediation is performed; if maintenance is performed on penetrations and isolation valves prior to the integrated test, the as-measured leakage rate plus the leakage savings resulting from such maintenance.

As left - leakage measured during an integrated leakage-rate test after remediation, if necessary, has been performed.

Containment isolation valve - any valve that is relied on to seal off the primary reactor containment from the outside atmosphere. Containment isolation valves are those that: (1) provide a direct connection between the inside and outside atmospheres of the primary reactor containment under normal operation, such as purge and ventilation, vacuum relief, and instrument valves, (2) are required to close automatically upon receipt of a containment isolation signal, (3) are required to operate intermittently under post-accident conditions, and (4) are in main steam and feedwater piping and other systems that penetrate containment of direct-cycle boiling water power reactors.¹

Containment penetrations - components designed to provide a pressure-containing or leakage-limiting boundary for piping and electrical systems penetrating the primary reactor containment. Included are containment penetrations whose design incorporates resilient seals, gaskets, or sealant compounds, piping penetrations fitted with expansion bellows, and electrical penetrations fitted with flexible metal seal assemblies; airlock door seals; and doors with resilient seals or gaskets except for seal-welded doors.¹

EPRI - acronym for the Electric Power Research Institute.

Exclusion area - area surrounding the reactor, in which the reactor licensee has the authority to determine all activities including exclusion or removal of personnel and property from the area.²

FSAR - Final Safety Analysis Report, document a utility submits to NRC in support of its request for an operating license.

ILRT - Integrated Leakage-Rate Test, test conducted to determine the leakage rate obtained from measurement of leakage through all potential leakage paths including containment welds, valves, fittings, components that penetrate containment, as well as the containment structure.

Individual latent cancer risk - calculated probability of dying from cancer due to an accident for an individual located within 10 miles of the unit; i.e., $\sigma (cf/pop)p$, where cf is the total number of latent cancer fatalities due to the direct exposure in the resident population, pop is the affected population size, p is the weather condition probability, and the summation is over all weather conditions.

L_a (percent/24 hours) - maximum allowable leakage rate at pressure P_a .¹

L_d (percent/24 hours) - design leakage rate at pressure P_a .¹

L_t (percent/24 hours) - maximum allowable leakage rate at pressure P_t .¹

Glossary

L_{am} , L_{tm} (percent/24 hours) - total measured containment leakage rates at pressures P_a and P_t , respectively, obtained from testing the containment with components and systems in the state as close as practical to that which would exist under design basis accident conditions (e.g., vented, drained, flooded, or pressurized).¹

Leakage rate - for test purposes, leakage which occurs in a unit of time, stated as a percentage of weight of the original content of containment air at the leakage-rate test pressure that escapes to the outside atmosphere during a 24-hour test period.¹

LER - Licensee Event Report, reporting mechanism required of licensees by the NRC to inform it of any nuclear unit condition potentially adverse to safety.

LLRT - Local Leakage-Rate Test, another name for Type B and Type C tests.

Low population zone - area immediately surrounding the exclusion area which contains residents, the total number and density of which are such that there is a reasonable probability that appropriate protective measures could be taken in their behalf in the event of a serious accident.²

Minimum path - for a penetration, leakage through the penetration accounting for the fact that there are multiple components in series providing isolation. If the penetration consists of two valves in series, and the first valve leaked 1 SCF/H and the second 10 SCF/H, the penetration minimum leakage path is 1 SCF/H. For containment as a whole, the minimum path leakage is the cumulative leakages summed across all penetrations.

Overall integrated leakage rate - leakage rate which is obtained from a summation of leakage through all potential leakage paths including containment welds, valves, fittings, and components that penetrate containment.¹

P_a (psig, pounds per square inch gauge) - calculated peak containment internal pressure related to the design basis accident and specified either in the technical specifications or associated licensing bases.¹

P_t (psig) - containment vessel reduced test pressure selected to measure the integrated leakage rate during periodic Type A tests.¹

Population center distance - distance from the reactor to the nearest boundary of a densely populated center containing more than about 25,000 residents.²

Population dose within entire region - exposure, expressed in effective dose equivalents (person-rem), due to early and chronic exposure pathways for the population within the entire affected region.

Population dose within 50 miles - exposure, expressed in effective dose equivalents (person-rem), due to early and chronic exposure pathways for the population within 50 miles of the reactor.

Primary reactor containment - structure or vessel that encloses the components of the reactor coolant pressure boundary (i.e., basically the reactor and its connected piping, pumps, hardware, etc.). The containment serves as an essentially leakage-tight barrier against the uncontrolled release of radioactivity to the environment.¹

Reactor containment leakage-test program - includes the performance of Type A, Type B, and Type C tests.¹

Technical specifications - with respect to nuclear power units, a document specifying the limiting conditions for continued operation which are consistent with the design basis of the unit.

Total latent cancer fatalities - total number of predicted latent cancer fatalities due to both early and chronic exposure.

Type A Tests - tests intended to measure the primary reactor containment overall integrated leakage rate (1) after the containment has been completed and is ready for operation, and (2) at periodic intervals thereafter.¹

Type B Tests - tests intended to detect local leaks in systems penetrating containment and to measure leakage across each pressure-containing or leakage-limiting boundary.¹

Type C Tests - tests intended to measure containment isolation valve leakage rates.¹

1. 10 CFR Part 50, Appendix J, Section II, "Explanation of Terms"

2. 10 CFR Part 100.3, "Definitions"

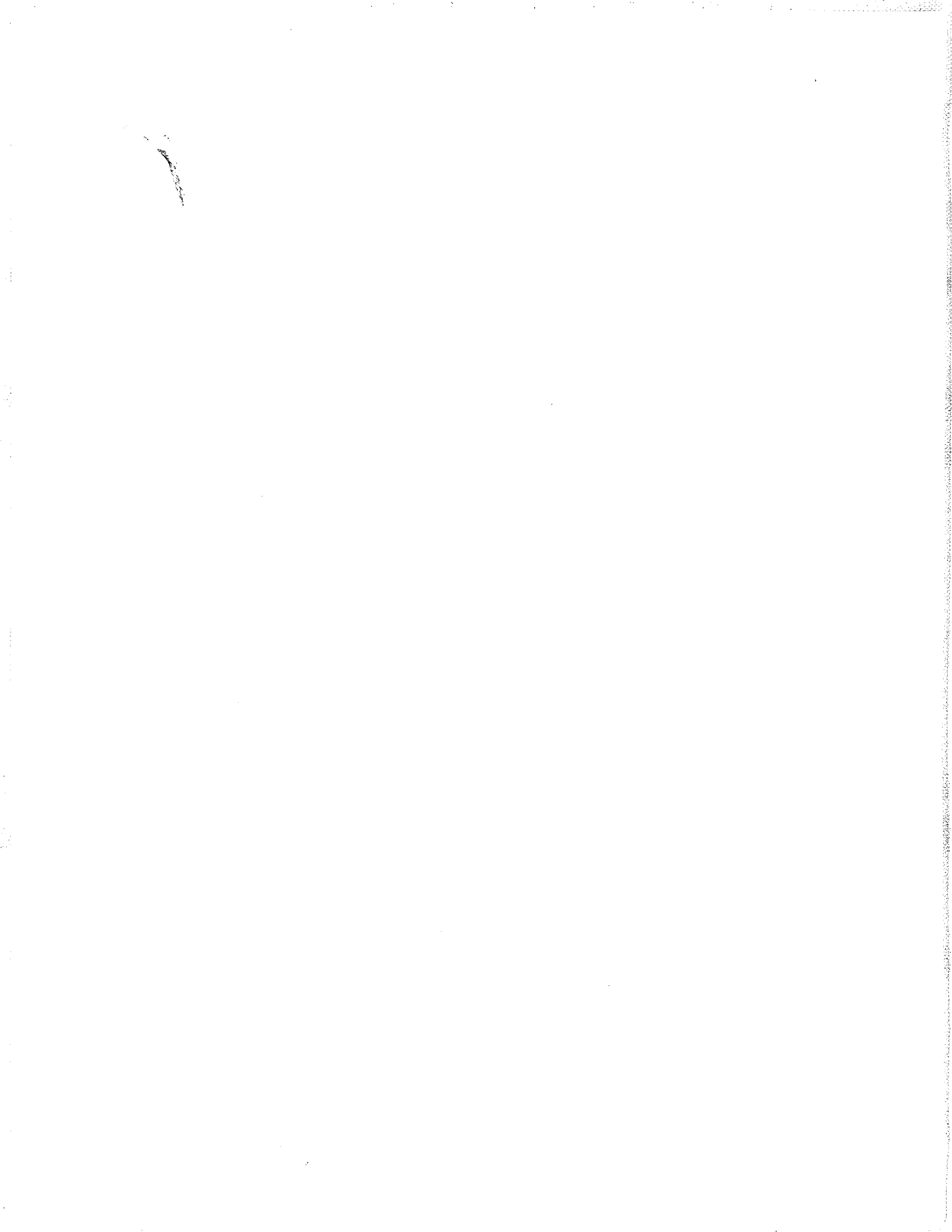

APPENDIX A

ANALYSIS OF TYPE B/C LEAKAGE-RATE HISTORY

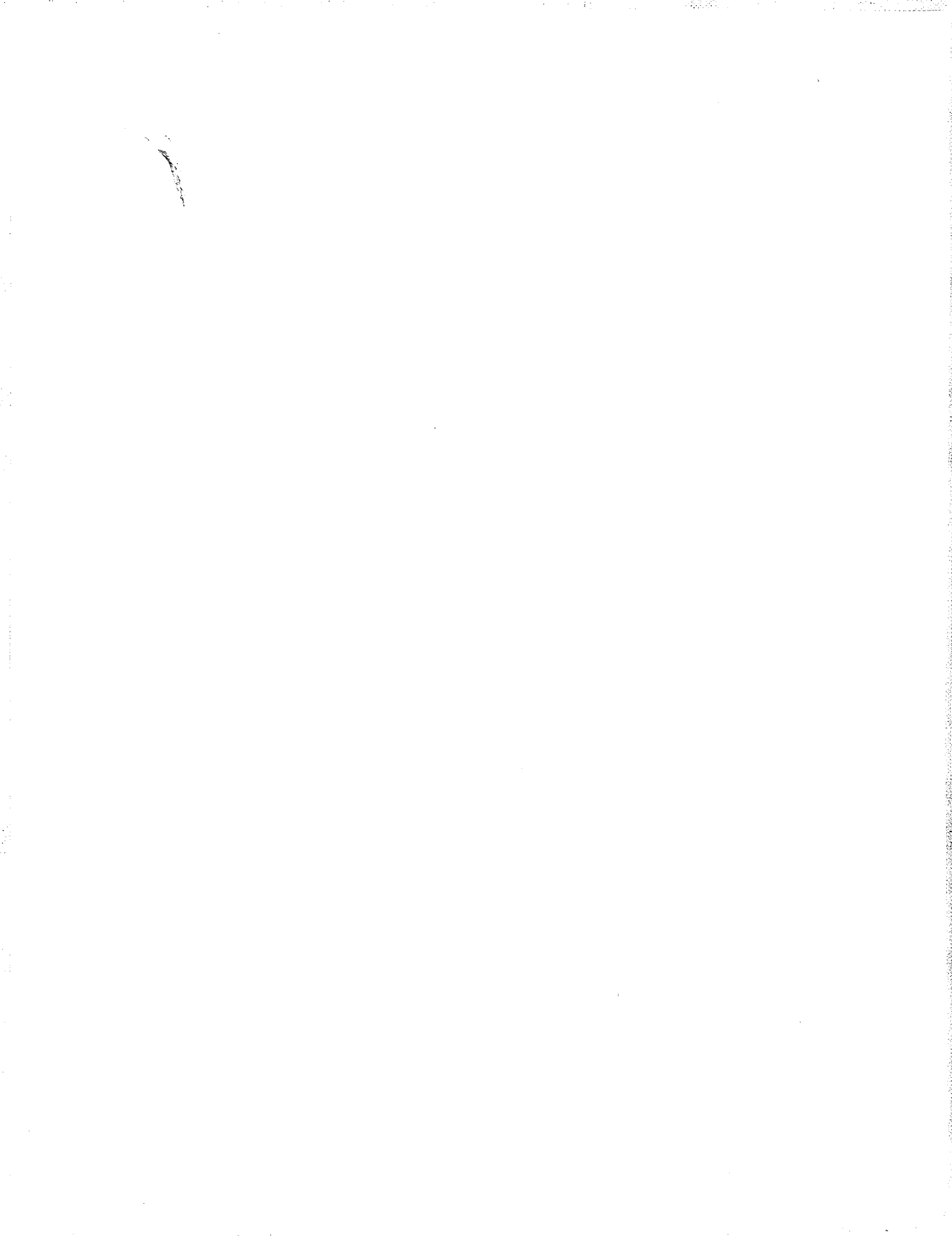

Contents

	<u>Page</u>
A.1 Introduction	A-1
A.2 North Anna Analyses	A-1
A.2.1 Type B LLRT	A-2
A.2.2 Type C LLRT	A-3
A.2.2.1 Historical Performance	A-3
A.2.2.2 Analysis of Historical Leakage-Rate Data	A-9
A.2.2.3 Statistical Analysis of Component Data	A-15
A.2.2.4 Test Options Analysis	A-26
A.3 Grand Gulf Analysis	A-29
A.4 Comparison of Results	A-35
A.5 Findings	A-35
Endnotes	A-39

Tables

<u>Number</u>	<u>Page</u>
A-1 Probability of Exceeding L_a at any Random Point in Time	A-6
A-2 Penetration Data	A-16
A-3 Class Variable Data Codes	A-24
A-4 Actual Versus Expected Number of Multiple Valve Failures Assuming Independent Failures	A-27
A-5 Actual Versus Expected Number of Multiple Valve Failures Assuming Dependent Failures	A-27
A-6 Probability of Indeterminate Containment Leakage Paths for Test Scheme Options ...	A-28
A-7 Change in Incremental Risk Due to Containment Leakage Relative to Current Test Scheme for Test Scheme Options	A-30
A-8 Probability of Indeterminate Containment Leakage Paths for Test Scheme Options - Data from 1990 to Present	A-31
A-9 Change in Incremental Risk Due to Containment Leakage Relative to Current Test Scheme for Test Scheme Options - Data from 1990 to Present	A-32
A-10 Containment Penetration Component Failures	A-32

Tables (Continued)

<u>Number</u>		<u>Page</u>
A-11	Component Statistics	A-33
A-12	Valve Failure Rates	A-33
A-13	Actual Versus Expected Number of Multiple Valve Failures Assuming Independent Failures	A-34
A-14	Actual Versus Expected Number of Multiple Valve Failures Assuming Independent Failures	A-34
A-15	Probability of Indeterminable Containment Leakage Paths for Test Scheme Options ..	A-37
A-16	Change in Incremental Risk Due to Containment Leakage Rate Relative to Current Test Scheme for Test Scheme Options	A-38
A-17	Comparison of Containment Isolation Valve Leakage Failure Rates	A-38
A-18	Comparison of Changes in Incremental Risk Due to Containment Leakage Rate Relative to Current Test Scheme for Test Scheme Options	A-38

Figures

<u>Number</u>		<u>Page</u>
A-1	Minimum Path Leakage Rate Versus Time - Linear Change in Leakage Rate Over Time (Max Component Flow 257 scf/h)	A-4
A-2	Minimum Path Leakage Rate Versus Time - Leakage Rate Maximum of Start and End Leakage Rates Over Time (Max Component flow 257 scf/h)	A-5
A-3	Minimum Path Leakage Rate Versus Time - Linear Change in Leakage Rate Over Time (Max Component Flow 500 scf/h)	A-7
A-4	Minimum Path Leakage Rate Versus Time - Leakage Rate Maximum of Start and End Leakage Rates Over Time (Max Component Flow 500 scf/h)	A-8
A-5	Number of Component Leakage Rates > 257 scf/h Versus Time	A-10
A-6	Component Leakage Rate Versus Time Since Maintenance	A-11
A-7	Number Component Leakage Rates > 257 scf/h Versus Time Since Maintenance	A-12
A-8	Leakage Rate at Maintenance Versus Leakage Rate at Last Test	A-13
A-9	Leakage Rate at Maintenance Versus Leakage Rate at Last Test - Magnified View ...	A-14

APPENDIX A

ANALYSIS OF TYPE B/C LEAKAGE-RATE HISTORY

A.1 INTRODUCTION

This appendix describes the analyses which were performed to determine the effect on nuclear unit risk resulting from changes in the testing schemes and testing intervals of components undergoing Type B and C tests. Extensive test result data and component data were collected at the North Anna Power Station through the cooperation of its owner and operator, Virginia Electric Power Company.¹ In addition, extensive test result data and component data were collected at the Grand Gulf Nuclear Station through the cooperation of its owner and operator, Entergy Operations.² In February, the Nuclear Management and Resources Council (NUMARC) submitted a letter (NUM94) summarizing data representative of a wide spectrum of nuclear power unit designs.

This data collection effort was performed to provide sufficient information for calculating the costs and man-rem exposure associated with local leakage-rate testing, and to identify and quantify the effect of component and system parameters on component leakage rates and component leakage-rate frequencies. This information was also used to develop models for evaluating the impact of alternative local leakage-rate testing schemes on the probability and magnitude of containment leakage rates.

The data collected for North Anna was evaluated to determine the historical containment leakage rates over time and the corresponding component leakage rates. This analysis was performed to identify any trends in these leakage rates, to provide a baseline against which changes in testing schemes or intervals are compared against, and to validate the containment penetration model used in these analyses. Next, data collected concerning individual penetration components (component characteristics and component service data) were analyzed to determine if component failure rates

could be predicted as a function of this data. Based on this analysis, no statistically significant differentiation in component failure rates could be found based on the component data. It was found, however, there was an increased probability of component failure if that component had previously failed. In addition, there is evidence of component common mode failures at the penetration level. Based on the above analyses, a Monte Carlo simulation model of the North Anna containment penetrations was constructed. This model was used to determine the risk impact of various component testing schemes and testing intervals.

Based on the insights gained from the North Anna analyses, a more restricted set of analyses was performed on the data gathered from Grand Gulf. The results of these analyses were in general agreement with the results of the North Anna analyses.

A.2 NORTH ANNA ANALYSES

The North Anna Power Station comprises two pressurized water reactors.³ Data collected at the power station consisted of the following:

- reactor containment building Integrated Leakage-Rate Test (ILRT) reports
- penetration leakage logs for 1985 through 1993 for Unit 1, and 1986 through 1993 for Unit 2
- time estimates for conducting Type A, B, and C tests
- estimated man-rem exposures for conducting Type A, B, and C tests
- dates of seal replacement or door adjustment for personnel air-lock, emergency escape air-lock, equipment hatch, and fuel transfer tube

- "as-found" leakage rates from component maintenance records
- containment penetration component configurations
- manufacturer, type, operator type, type of service (i.e., chromated water, compressed air, etc.), number of operations per operating cycle (18 months), hours of flow per operation, and flow rate, temperature, and pressure seen by the valve during operation for each containment isolation valve tested during the Type C tests

A.2.1 Type B LLRT

Type B tests are performed on two types of equipment: electrical penetrations and air-locks (and other double-gasketed and double O-ring seals). Due to the vast differences in these two types of equipment leakage tests, they are described separately below.

Each unit contains approximately 130 electrical penetrations. Type B tests are performed on each of these penetrations approximately every 18 months. Between tests, each penetration is left pressurized and attached to a pressure gauge which is checked monthly. If a pressure gauge shows a low, but non-zero pressure, the penetration is repressurized using a portable compressed air source. If a pressure gauge shows zero pressure, a Type B leakage test is performed on the penetration. In all such cases but one, the cause of the leakage was found to be the connection to the pressure gauge, rather than leakage of the penetration itself. In the one case where the electrical penetration was leaking, the leakage rate was too small to measure using standard leakage-test equipment. The specific location of the leakage had to be determined by pressurizing the penetration with helium and using a helium leakage-detector probe. The leakage on the bundle was corrected by tightening the nut on the bundle by a quarter turn. Based on this information, North Anna has experienced no significant electrical

penetration leakage in approximately 27 unit-years of operation.

Based on the above information, performance-based Type B testing would result in a significant reduction in tests of the electrical penetrations. If the leakage pattern of these penetrations do not deviate from the historical leakage pattern, an insignificant increase in risk would result from performance-based testing of these penetrations.

Type B testing is performed on all air-locks, i.e., the fuel transfer tube, the personnel air-lock, the emergency escape air-lock, and the equipment hatch. The fuel transfer tube is tested approximately every 18 months. The personnel air-lock, emergency escape air-lock, and equipment hatch are tested on a 6-month test interval and can be tested during power operation. North Anna maintains an aggressive maintenance program for these penetrations.

North Anna maintains a policy of zero allowed leakage on the equipment hatch. If any leakage is detected through the equipment hatch door seals, the leakage test is terminated and the leakage corrected. No "as-found" leakage rate is determined for the equipment hatch during Type B tests unless the test coincides with an integrated leakage-rate test. Since June 1987, a seal has been replaced on the Unit 1 equipment hatch five times. Since April 1989, a seal has been replaced on the Unit 2 equipment hatch two times.

The door seals for the fuel transfer tubes in Unit 1 and Unit 2 were replaced in December 1985 and August 1984, respectively. There has been zero leakage through these seals since that time.

Since January 1986, either a personnel air-lock seal has been replaced or a door adjusted 13 times for Unit 1. Since August 1986, either a personnel air-lock seal has been replaced or a door adjusted 12 times for Unit 2. Maximum path leakage rates for both Unit 1 and Unit 2 personnel air-locks have ranged from zero to 22 scf/h.

Since June 1987, either an emergency air-lock seal has been replaced or a door adjusted five times for Unit 1 and five times for Unit 2. Maximum path leakage rates for both Unit 1 and Unit 2 emergency air-locks have ranged from zero to 9 scf/h.

Based on the above information, performance-based Type B testing would not result in a significant reduction in tests of the air-locks. In all cases except for the fuel transfer tubes, repairs have been performed on the air-lock seals often enough that the seals would not meet the performance requirements necessary to reduce their test intervals.

A.2.2 Type C LLRT

A.2.2.1 Historical Performance

Prior to the data collection effort at North Anna, a group of system and component parameters were identified that might have an impact on the frequency of containment isolation valve leakage and the distribution of leakage rate over time once the valve started to leak. The parameters identified were: manufacturer, type, operator type, type of service (i.e., chromated water, compressed air, etc.), number of operations per operating cycle (18 months), average hours with flow per operation, and the flow rate, temperature, and pressure seen by the valve during operation. These data, along with the as-found and as-left leakage rates for each containment isolation valve tested during the Type C tests and the component configuration for each containment penetration, were collected for both units at North Anna.

The first step in the analysis was to establish the historical performance of the containment isolation components. This provides a baseline against which performance-based alternatives to the current leakage-rate testing scheme can be measured.

Based on the as-found and as-left leakage rates, a master time-line matrix was built showing component leakage rates over time and when each component was placed in maintenance to correct leakage. Based on the containment penetration component configuration

information, a computer model was built to calculate the minimum path leakage rate for each penetration and, by summing the penetration minimum path leakage rates, the overall containment minimum path leakage rate. The penetration minimum path leakage rate was calculated by taking the minimum of the leakage rates for components or component trains in series, and the maximum of the leakage rates for components or component trains in parallel for all flow paths through the penetration.

Based on the time-versus-component-leakage-rate matrix and the containment penetration leakage model, the overall containment leakage rate versus time was determined for each unit. The minimum path containment leakage rate versus time since January 1985 for each unit is shown in Figure A-1. Two assumptions were made in calculating the unit leakage rates. The first assumption was that the component leakage rate for a component varied linearly over time between the time-points where component leakage rate was measured. For example, if the component leakage rate was measured at zero scf/h at time 100, and 10 scf/h at time 110, the component leakage rate at time 105 was estimated to be 5 scf/h. The second assumption regards component leakage rates that were indeterminable during Type C leakage testing. The leakage-test equipment used during Type C testing can measure leakage rates up to approximately 257 scf/h. If a component had a leakage rate greater than this amount, the component leakage rate was recorded as ">257." In this figure, a leakage rate of 257 scf/h was assumed when the component leakage rate was indeterminable. Due to these assumptions, this figure can be interpreted as the expected value of the containment leakage rate versus time. In order to determine the sensitivity of the minimum path leakage rate to the first assumption (linear change in leakage rate over time), Figure A-2 was created. This figure assumes that the component leakage rate between time-points where the component leakage rate was measured is the maximum of the two leakage rates. This figure can be interpreted as the worst-case containment leakage rate versus time assuming no component leaks more than 257 scf/h.

Min Path Leak Rate Versus Time

(Linear Change in Leak Rate Over Time)

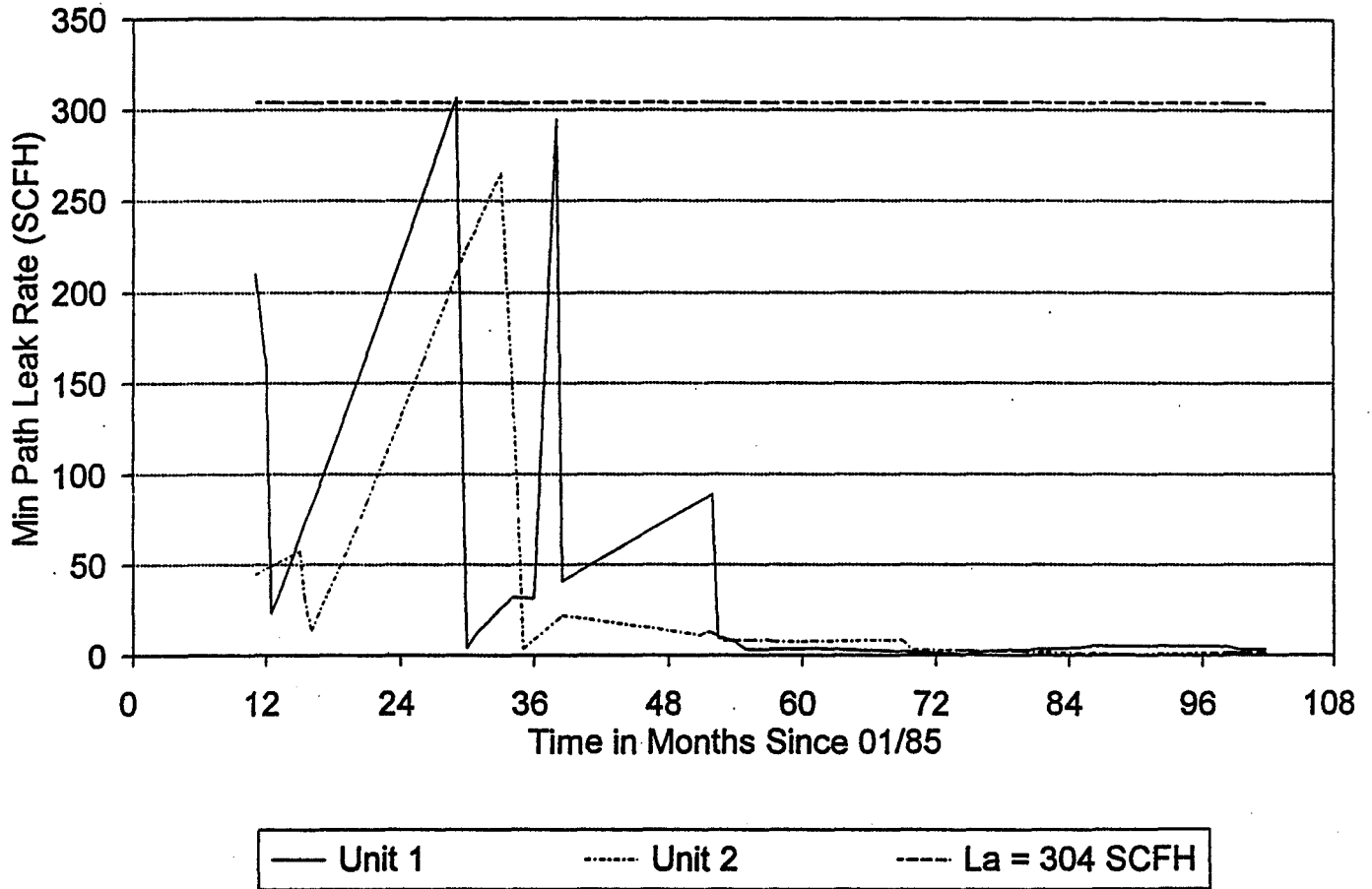

Figure A-1. Minimum Path Leakage Rate Versus Time - Linear Change in Leakage Rate Over Time (Max Component Flow 257 scf/h) assuming no component leaks more than 257 scf/h.

Min Path Leak Rate Versus Time

(Max of Start and End Leak Rates)

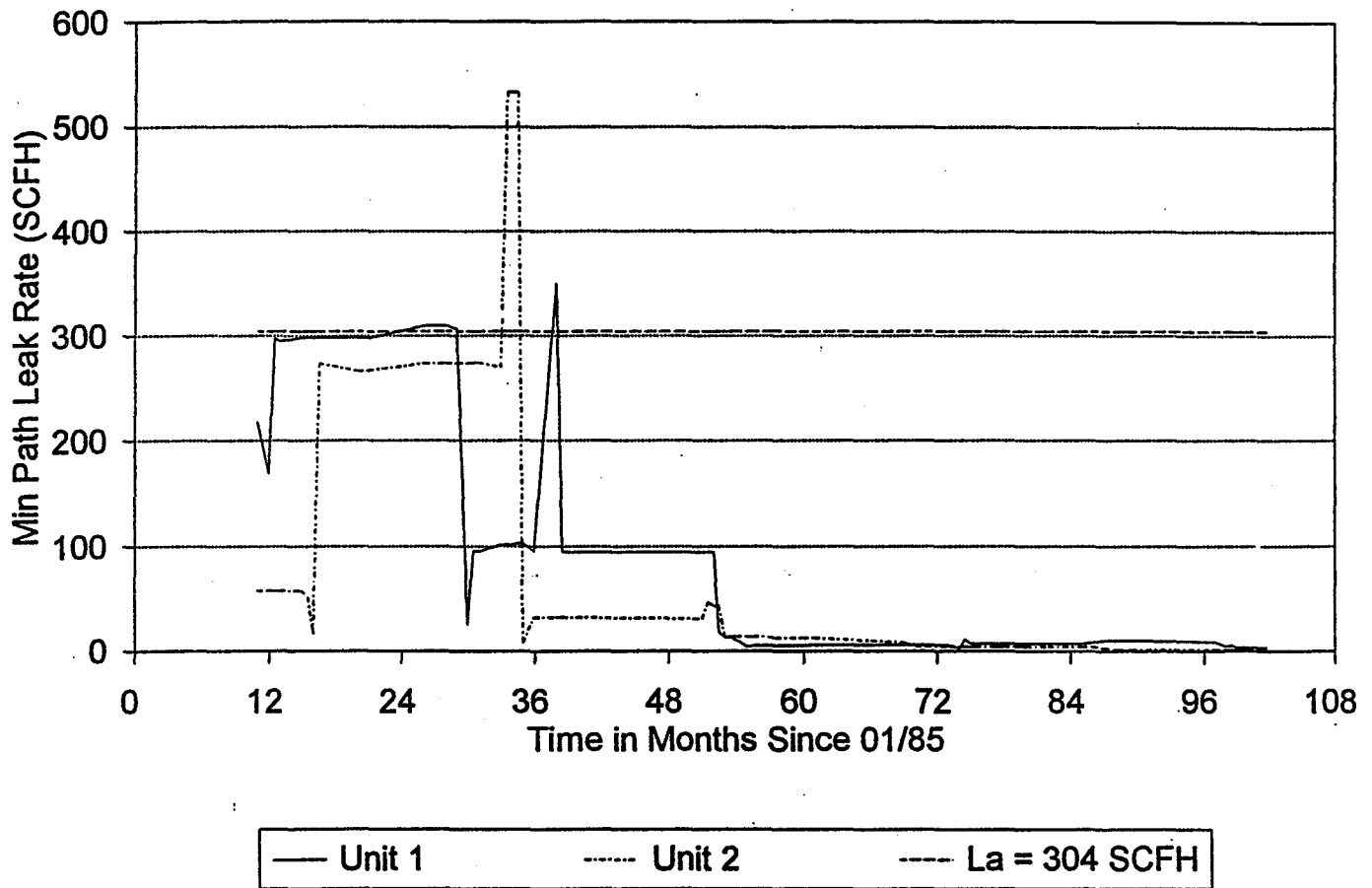

Figure A-2. Minimum Path Leakage Rate Versus Time - Leakage Rate Maximum of Start and End Leakage Rates Over Time (Max Component Flow 257 scf/h)

In order to determine the sensitivity of the minimum path leakage rate to the second assumption (maximum component leakage rate of 257 scf/h), Figure A-3 was created. In this figure, a leakage rate of 500 scf/h was assumed when the component leakage rate was indeterminable and the leakage rate for a component is linear over time. Figure A-4 assumes that the component leakage rate between time-points where the component leakage rate was measured is the maximum of the two leakage rates, and a leakage rate of 500 scf/h was assumed when the component leakage rate was indeterminable. A leakage rate of 500 scf/h in Figures A-3 and A-4 was selected when the component leakage rate was indeterminable simply because it was higher than L_a (304 scf/h), but less than twice the maximum measurable component leakage rate ($2 \times 257 = 514$ scf/h). Assigning a leakage rate of 500 scf/h forces the containment minimum path leakage rate above L_a in these two figures if all components in a series pathway for a penetration are leaking at an indeterminable rate at the same time (i.e., the penetration minimum path leakage rate was indeterminable). As there is no way to know what the actual component leakage rate was in these cases, the actual leakage rate could have been less than 500 scf/h (but higher than 257 scf/h) or significantly higher than 500 scf/h.

Based on a review of LER summaries regarding failures of containment isolation detected by Type C testing, leakage rates in the thousands of scf/h have been measured for isolation valves⁴. The assumptions used for Figure A-4 (500 scf/h maximum component leakage rate, component leakage rate the maximum of the as-left and as-found leakage rates between time points) are referred to as the worst-case assumptions in the remainder of this appendix.

By sampling the containment leakage rates shown in Figures A-1 to A-4, the probability of North Anna Units 1 and 2 having historically exceeded L_a at any random point in time can be determined for each set of assumptions. Table A-1 shows the probability of having exceeded L_a at any random point in time for the cases described above. From this table, it can be seen that having a containment leakage rate greater than L_a ranges from zero percent of the time (Unit 2, most optimistic conditions) to 22.6 percent of the time (Unit 1, worst-case assumptions.) As can be seen from Figure A-4, even under worst-case assumptions (component leakage rate above L_a when indeterminable, component leakage rate between test points the maximum of the start and end leakage rates), no containment minimum path leakage rates approaching L_a have occurred since mid-1988

Table A-1. Probability of Exceeding L_a at any Random Point in Time

Maximum Component Leakage Rate (scf/h)	Calculation Method for Leakage Rates Between Measured Time-points	Probability of Having Minimum Path Leakage Rate Greater Than L_a at Random Point in Time	
		Unit 1	Unit 2
257	Linear change over time	0.004	0.000
500	Linear change over time	0.127	0.022
257	Maximum of start and end leakage rates	0.104	0.089
500	Maximum of start and end leakage rates	0.226	0.209

Min Path Leak Rate Versus Time

(Linear Change in Leak Rate Over Time)

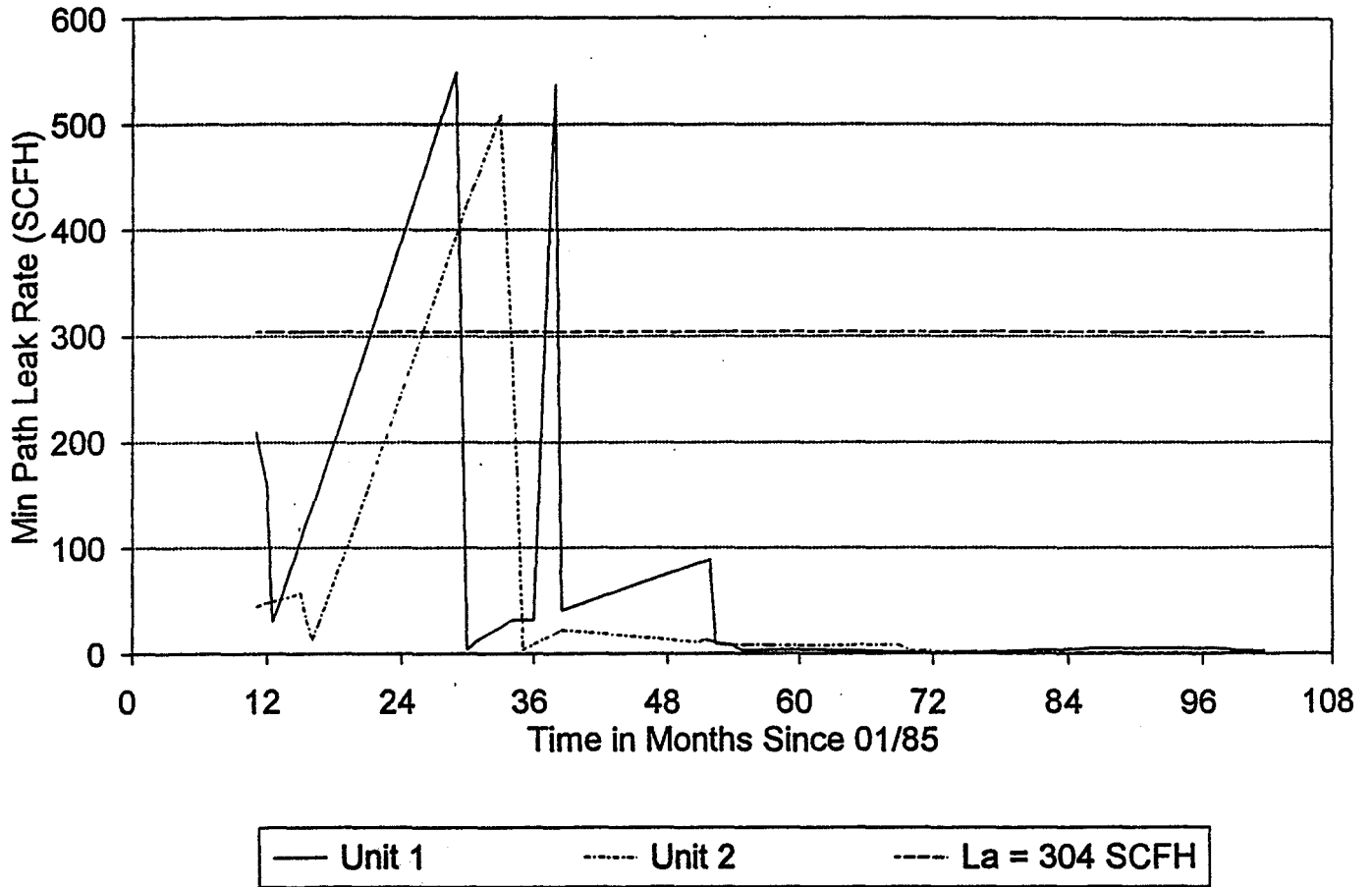

Figure A-3. Minimum Path Leakage Rate Versus Time - Linear Change in Leakage Rate Over Time (Max Component Flow 500 scf/h)

Min Path Leak Rate Versus Time

(Max of Start and End Leak Rates)

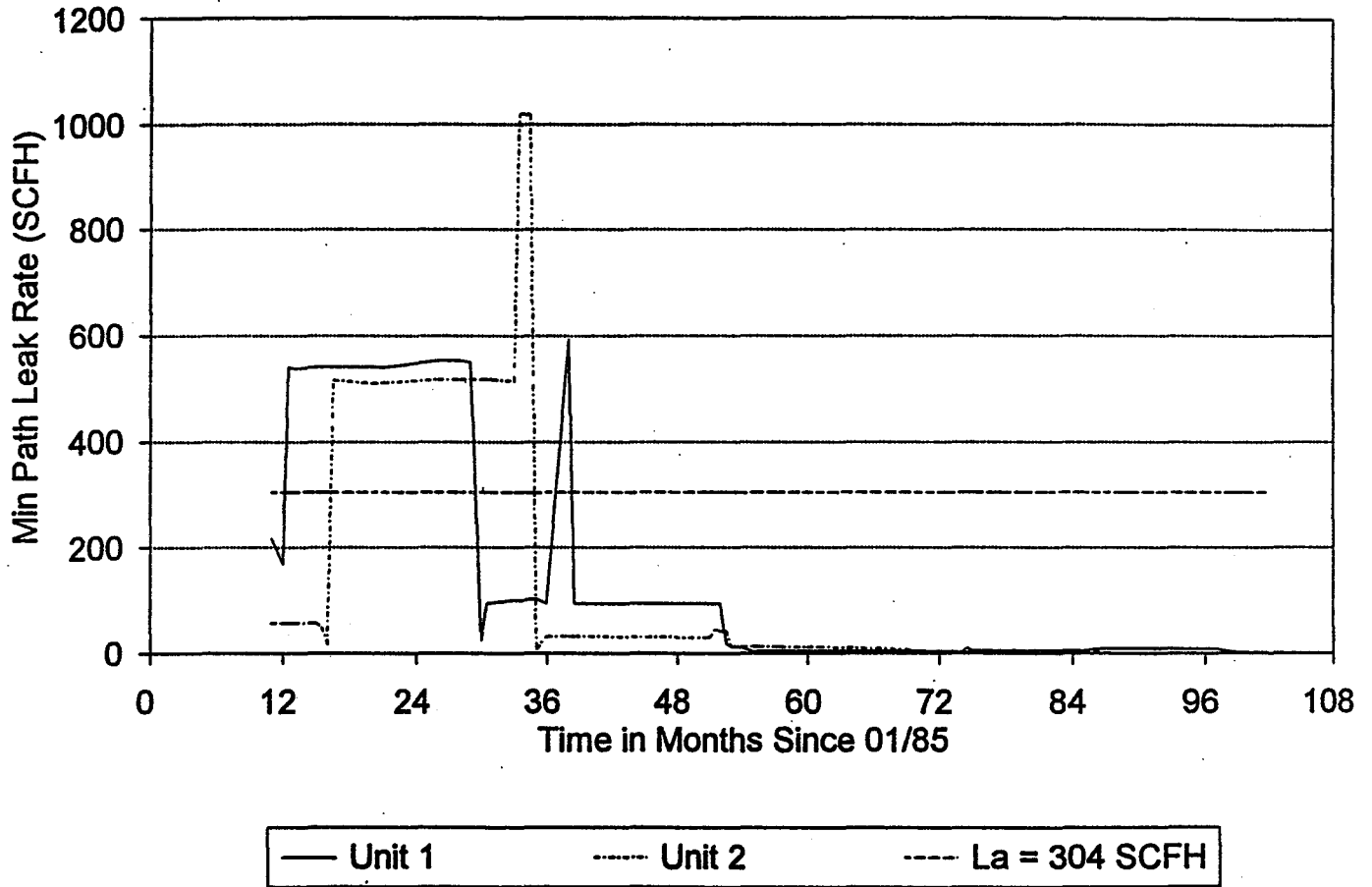

Figure A-4. Minimum Path Leakage Rate Versus Time - Leakage Rate Maximum of Start and End Leakage Rates Over Time (Max Component Flow 500 scf/h)

for either Unit 1 or Unit 2. Since mid-1989, the containment minimum path leakage rate for each unit has been less than 15 scf/h.

Figure A-5 shows the number of times a component with a leakage rate of 257 scf/h or more was found versus time since January 1985. From this figure, it can be seen that there have been occurrences of components leaking at an indeterminable rate since mid-1988, but there has not been a simultaneous indeterminable leakage rate for all components constituting a series containment leakage-rate path. The number of such components found during each refueling outage has ranged from zero to ten. In several cases, additional such components were found during tests between refueling outages.

A.2.2.2 Analysis of Historical Leakage-Rate Data

The historical component leakage-rate data collected from North Anna covered approximately 7 years of experience for each unit. This amount of data is insufficient for directly evaluating the impact of performance-based testing schemes, some of which relax the testing interval for selected components to one test in ten years. In order to evaluate the impact of altering the Type C testing scheme, a means of probabilistically estimating component performance over a longer period of time is required. The data collected from North Anna were examined several different ways in order to attempt to build a component model to predict future component performance.

Figure A-6 shows a scatter plot of individual component leakage rates versus time since last maintenance on the component. In creating this figure, it was assumed that all components had undergone maintenance 18 months prior to the first leakage-rate test recorded in the data collected from North Anna. The leakage rates presented in this figure are the measured as-found leakage rates of the components. Spikes in the figure can be seen at 18, 36, 54, and 72 months, which correspond to the normal 18 month testing interval. In this figure, if a component had a leakage rate greater than 257 scf/h (the maximum measurable leakage rate), the component leakage rate was recorded as 257.

Since Figure A-6 is a scatter plot, the number of occurrences of a given leakage rate at a given time since maintenance is not shown. Figure A-7 shows the number of times a component with a leakage rate of 257 scf/h or more was found versus time since last maintenance on the component.

These figures show that many of the component failures occur relatively soon (within 36 months) after the previous maintenance event. This suggests that the component failure rate decreases versus the time since last maintenance. Based on Figure A-7, approximately 66 percent of the failures occurred within 36 months of the previous maintenance event.

Figure A-8 shows a scatter plot of component leakage rate at maintenance versus the as-left leakage rate from the last test performed on the component. Figure A-9 is the same as Figure A-8, except only as-found leakage rates up to 30 scf/h are shown. For reference, there were 57 cases where the as-found leakage rate was 250 scf/h or greater, 40 cases where the as-found leakage rate was between 25 and 249 scf/h, and 181 cases where the as-found leakage rate was between zero and 24 scf/h. From these two figures, several observations can be made. First, in all cases where the component as-found leakage rate was greater than 25 scf/h, the as-left leakage rate at the last test was less than 2 scf/h. Second, combined with the number of components where the as-found leakage rate was 250 scf/h or greater, this figure shows that when a component fails with a high leakage rate, the degradation from a small leakage rate to a high leakage rate occurs rapidly. This is not to say that all leakage rates increase rapidly. Figure A-9 shows that in many cases the component leakage rate increases slowly.

Estimation of the future performance of containment isolation components based on the above figures is restricted by the unavailability of a leakage rate versus time history of components once they begin to leak. The reason for this is that North Anna performs maintenance on the components once they begin to leak at a rate

Component Leak Rate >257 vs Time

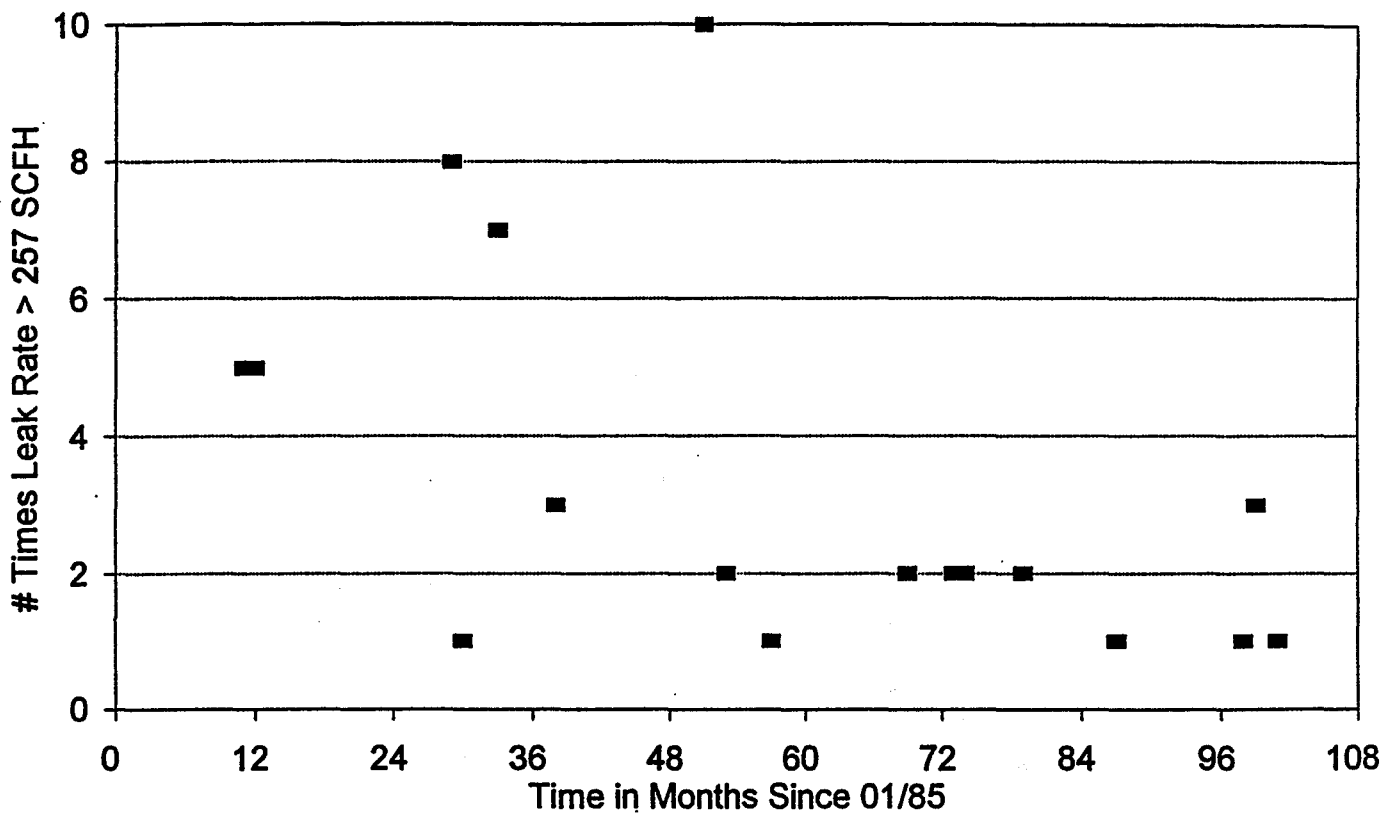

Figure A-5. Number of Component Leakage Rates > 257 scf/h Versus Time

Leak Rate vs. Time Since Maintenance

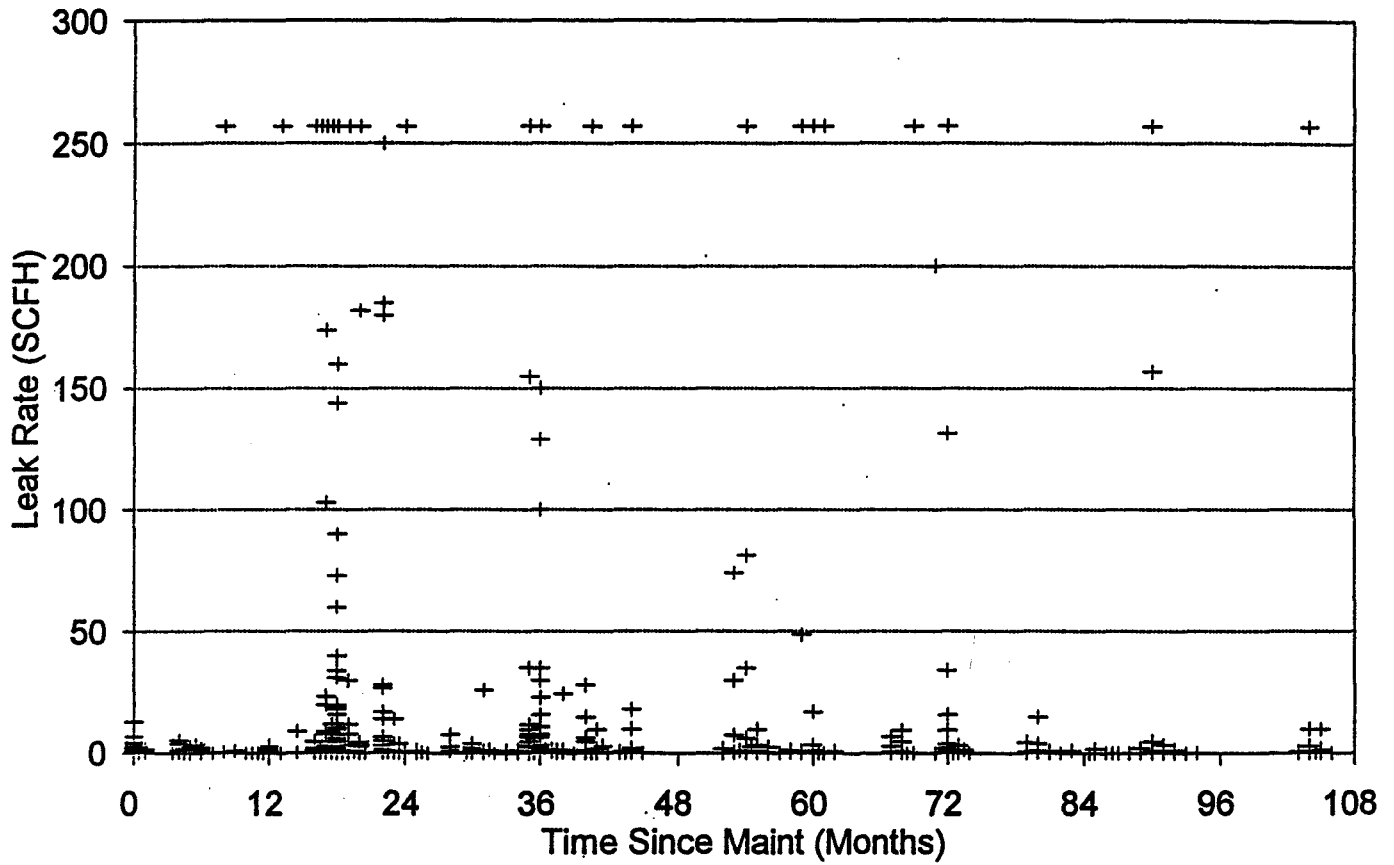

Figure A-6. Component Leakage Rate Versus Time Since Maintenance

Component Leak Rate >257 vs Time Since Maint

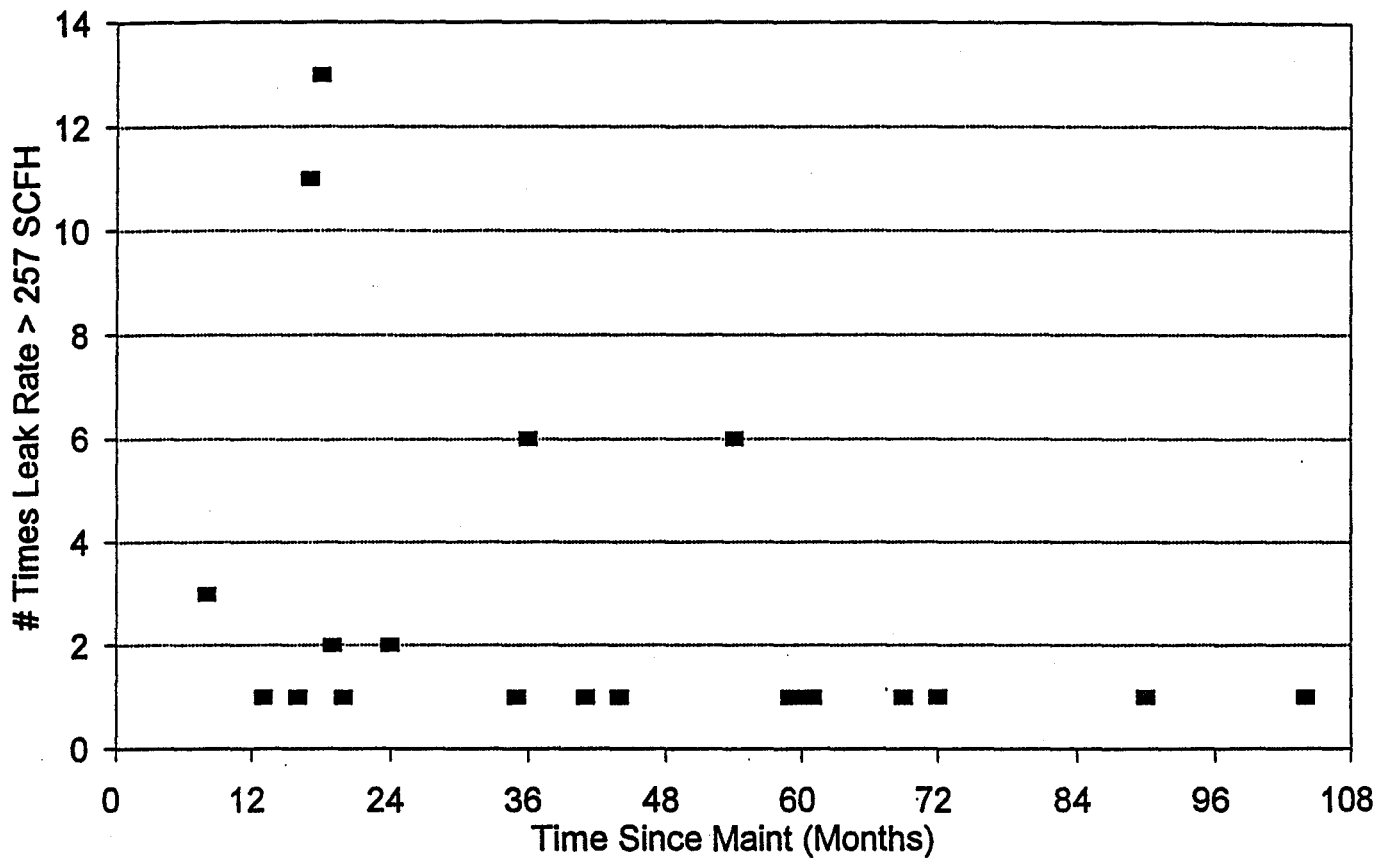

Figure A-7. Number Component Leakage Rates > 257 scf/h Versus Time Since Maintenance

Leak Rate at Maintenance vs. Leak Rate at Last Test

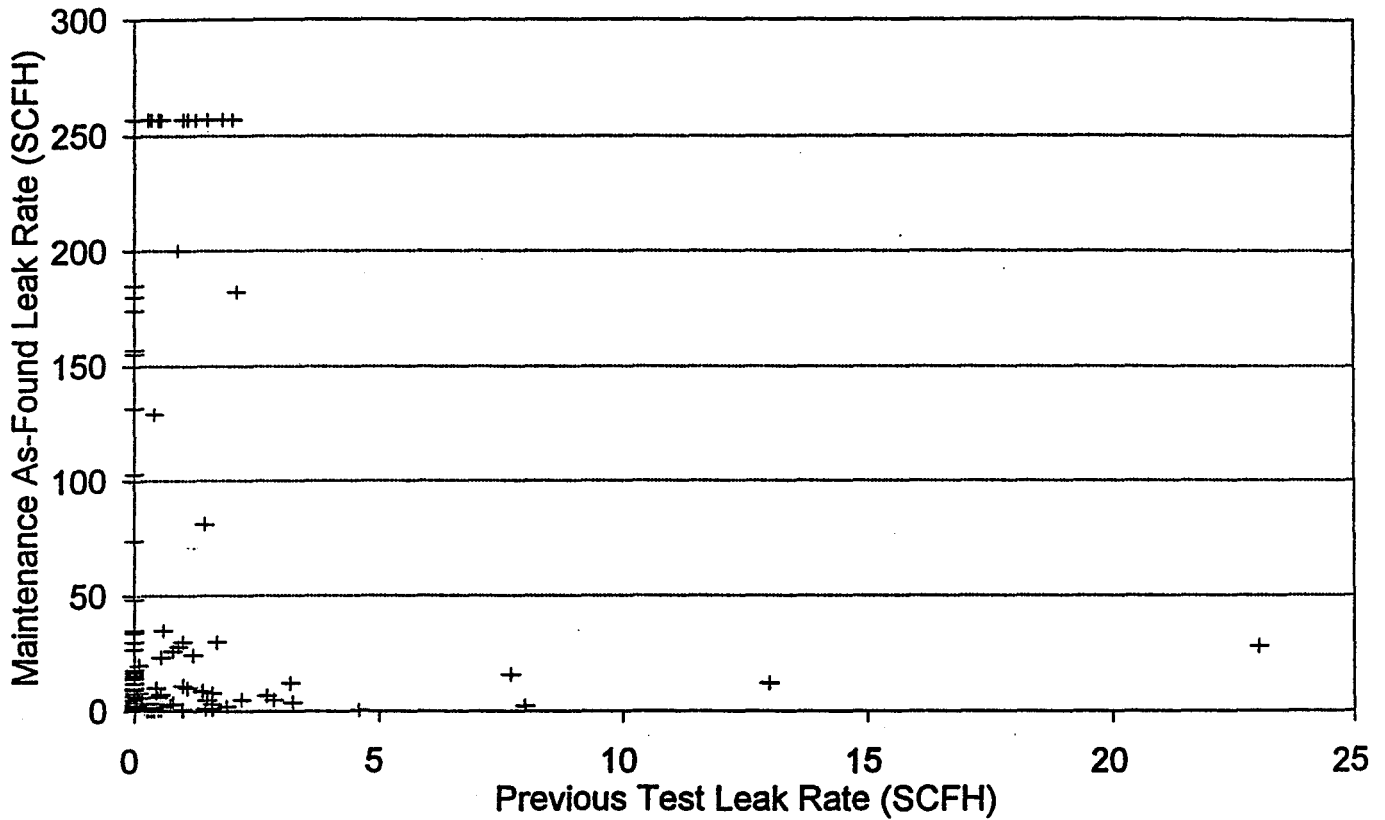

Figure A-8. Leakage Rate at Maintenance Versus Leakage Rate at Last Test

Leak Rate at Maintenance vs. Leak Rate at Last Test

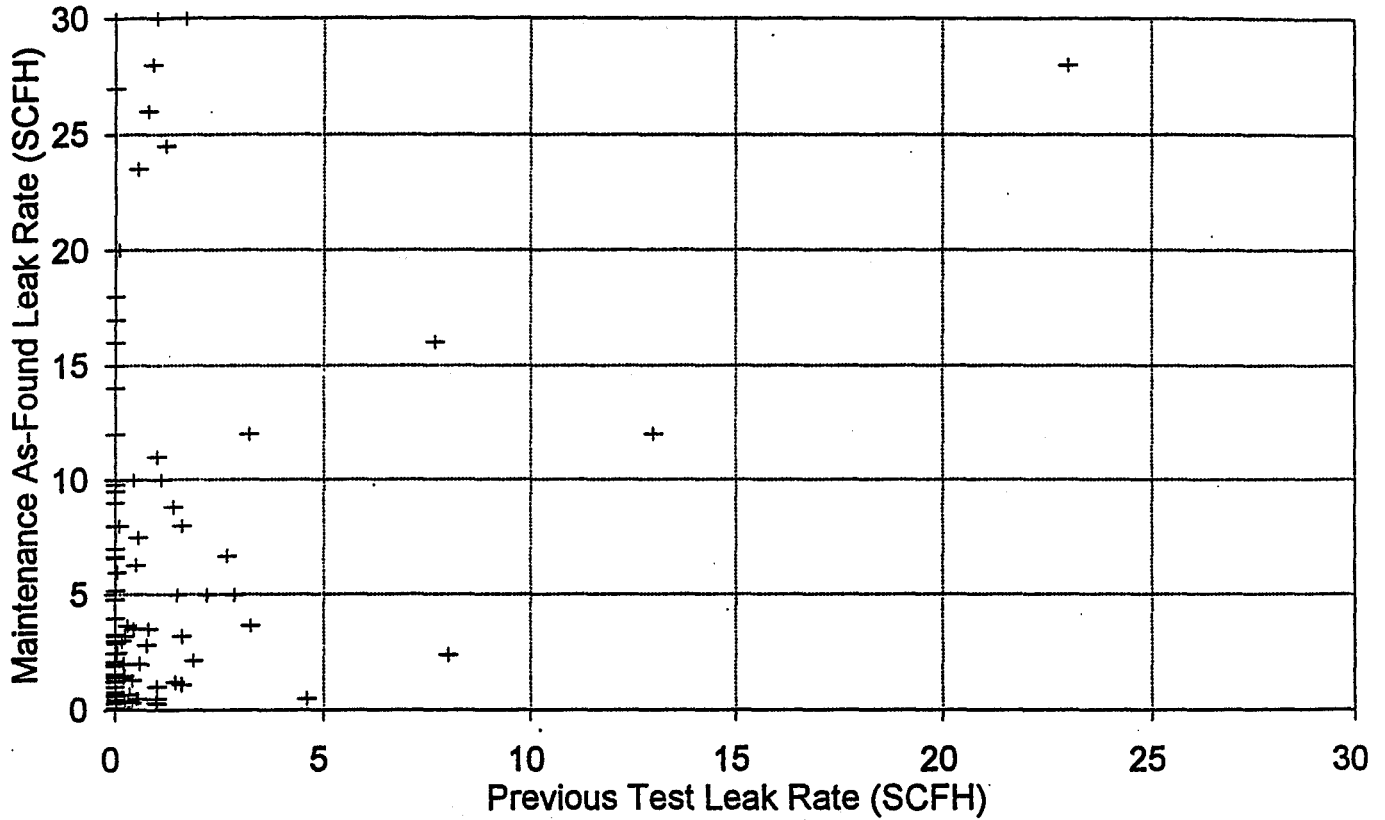

Figure A-9. Leakage Rate at Maintenance Versus Leakage Rate at Last Test - Magnified View

above the normal expected leakage rate for the component. This is perfectly understandable for unit operations, but prevents determining the rate at which the leakage rate for components increase once they begin to leak. Because of this, it is uncertain whether the components with leakage rates between 25 scf/h and 250 scf/h were: caught on a rapid increase to above 257 scf/h, increasing slowly, or had plateaued at the measured leakage rates.

From the data described above, an estimate of four component failures (leakage rate > 250 scf/h) per year per unit was made for time independent failures of components. Since each unit has an average of 196 components, if we assume no difference in failure rate due to component or system parameters, the component failure rate per year is approximately $1.8E-2$. If we assume perfect repairs, a containment leakage rate failure rate of $7E-2$ per year was calculated based on penetration configurations across both units.⁵ This corresponds to one containment leakage-rate failure every ten refueling outages for each unit. At each refueling outage, an average of five components would have failed. Comparing this number to the number of component failures show in Figure A-5, it can be seen that this calculated failure rate is about double the failure rate that has been experienced at North Anna since April 1989. The calculated number of failures expected per outage is higher due to the large number of component failures that occurred earlier in the unit lives.

A.2.2.3 Statistical Analysis of Component Data

As previously described, the data gathered from North Anna was insufficient to directly evaluate the impact of performance-based testing schemes. In order to evaluate these testing schemes, a model was constructed to predict containment leakage based on the component configuration for each containment penetration. In order to make the containment leakage model as accurate as possible, a series of analyses were performed to determine how the individual components should be modeled.

The first analysis was a statistical data analysis which was performed to investigate the effect of component and system parameters on the component failure rate. The intent of this analysis was to determine whether component leakage failure rates should be assigned based on these parameters, or whether a generic failure rate could be assigned to all components. Table A-2 lists the data collected for each component. For class-variable data (data with qualitative values), Table A-3 lists the meaning for each qualitative value. Based on this information and the time between maintenance events for each component, a statistical analysis of variance (ANOVA) was performed.

The statistical analysis considered the length of time a particular component was in service before requiring maintenance. Each component was categorized using nine variables: operator type, valve type, type of service, size, operations per operating cycle, hours of flow per operating cycle, flow, temperature, and pressure. The analysis sought to assess which of the nine variables were most predictive of the time until maintenance was required. Each component's time to maintenance was either interval or right censored. Components that required maintenance following inspection were interval censored since the component had degraded sufficiently to require service sometime between the inspection that identified the problem and the previous inspection. The specific time point at which the component required maintenance was unknown. Components that never required maintenance following inspection were right censored since maintenance would not be required until sometime after the data collection period ended. A data set was created containing the nine descriptive variables, the number of hours the component was in service before maintenance was required, and whether the component maintenance time was interval or right censored.

A forward step-wise regression procedure was utilized to determine which variables were most

Table A-2. Penetration Data

PEN #	Unit 1		Unit 2		Function	Op Type	Type	Size	Service	Ops/ Cycle	Hours Flow/ Op	Flow (gpm/ scfm)	Temp (°F)	Press (psig)
	Comp ID	Manuf	Comp ID	Manuf										
1	1-CC-TV-103B	F130	2-CC-TV-203B	F130	CC FM B RHR HX	H	B	18	C	6	120	10500	107	35
2	1-CC-193	P340	2-CC-194	M360	CC TO A RHR HX	J	C	18	C	1	720	10500	105	85
4	1-CC-198	M360	2-CC-199	M360	CC TO B RHR HX	F	C	18	C	1	720	10500	105	85
5	1-CC-TV-103A	F130	2-CC-TV-203A	F130	CC FM A RHR HX	H	B	18	C	6	120	10500	105	80
7	1-SI-79	V085	2-SI-93	V085	HHSI (BIT)	H	C	3	B	1	8	600	160	0
7	1-SI-77	R340	2-SI-83	V085		A	F	2	B	0	0	0	160	0
7	1-SI-MOV-1867C	V085	2-SI-MOV-2867C	V085		B	E	3	B	6	1.3	300	160	0
7	1-SI-MOV-1867D	V085	2-SI-MOV-2867D	V085		B	E	3	B	6	1.3	300	160	0
8	1-CC-TV-101B	F130	2-CC-TV-201B	F130	CC FM RCP THERM BARRIERS	D	F	4	C	1	13140	120	130	40
8	1-CC-TV-101A	F130	2-CC-TV-201A	F130		H	F	4	C	1	13140	120	130	60
9	1-CC-572	M360	2-CC-302	M360	CC TO C RACC	H	C	6	D	1	13140	400	70	90
10	1-CC-559	M360	2-CC-289	M360	CC TO B RACC	J	C	6	D	1	13140	400	70	90
11	1-CC-546	M360	2-CC-276	M360	CC TO A RACC	H	C	6	D	1	13140	400	70	90
12	1-CC-TV-105B	F130	2-CC-TV-205B	F130	CC FM B RACC	D	B	6	D	6	2190	400	77	40
12	1-CC-TV-100B	F130	2-CC-TV-200B	F130		D	B	6	D	6	2190	400	77	40
13	1-CC-TV-105C	F130	2-CC-TV-205C	F130	CC FM C RACC	D	B	6	D	6	2190	400	77	40
13	1-CC-TV-100C	F130	2-CC-TV-200C	F130		D	B	6	D	6	2190	400	77	40
14	1-CC-TV-105A	F130	2-CC-TV-205A	F130	CC FM A RACC	D	B	6	D	6	2190	400	77	40
14	1-CC-TV-100A	F130	2-CC-TV-200A	F130		D	B	6	D	6	2190	400	77	40
15	1-CH-322	V085	2-CH-335	V085	CHARGING	F	C	3	B	1	13140	65	130	2500
15	1-CH-MOV-1289 A	V085	2-CH-MOV-2289 A	V085		B	E	3	B	1	13140	65	130	2500
16	1-CC-154	M360	2-CC-152	M360	CC TO C RCP AND SHROUD	F	C	8	C	1	13140	715	105	80
16	1-CC-TV-104C	F130	2-CC-TV-204C	F130		H	B	8	C	1	13140	715	105	85

Table A-2 (Continued)

PEN #	Unit 1		Unit 2		Function	Op Type	Type	Size	Service	Ops/ Cycle	Hours Flow/ Op	Flow (gpm/ scfm)	Temp (°F)	Press (psig)
	Comp ID	Manuf	Comp ID	Manuf										
17	1-CC-119	M360	2-CC-115	M360	CC TO B RCP AND SHROUD	F	C	8	C	1	13140	715	105	80
17	1-CC-TV-104B	F130	2-CC-TV-204B	F130		H	B	8	C	1	13140	715	105	85
18	1-CC-84	M360	2-CC-78	M360	CC TO A RCP	F	C	8	C	1	13140	715	105	80
18	1-CC-TV-104A	F130	2-CC-TV-204A	F130		H	B	8	C	1	13140	715	105	85
19	1-CH-402	K085	2-CH-331	K085	SEAL WTR FM RCP'S	H	C	.75	B	0	0	0	166	0
19	1-CH-MOV-1380	A200	2-CH-MOV-2380	A200		B	E	3	B	1	13140	10	166	100
19	1-CH-MOV-1381	A200	2-CH-MOV-2381	A200		B	E	3	B	1	13140	10	166	100
20	1-SI-110	R340	2-SI-136	K085	SI ACCUM MAKEUP	H	C	1	B	3	8	15	105	650
20	1-SI-58	R340	2-SI-47	R340		A	F	1	B	3	8	15	105	650
22	1-SI-185	V085	2-SI-85	V085	HHSI (ALT CH) TO COLD LEGS	H	C	3	B	0	0	0	160	0
22	1-SI-MOV-1836	V085	2-SI-MOV-2836	V085		B	E	3	B	0	0	0	180	0
24	1-RH-36	A200	2-RH-37	A200	RHR TO RWST	A	E	6	B	1	8	2500	123	100
24	1-RH-37	P032	2-RH-38	C684		A	E	6	B	1	8	2500	123	100
25	1-CC-TV-102F	F130	2-CC-TV-202F	F130	CC FM A RCP AND SHROUD	H	B	8	C	1	13140	675	116	40
25	1-CC-TV-102E	F130	2-CC-TV-202E	F130		H	B	8	C	1	13140	675	116	35
26	1-CC-TV-102B	F130	2-CC-TV-202B	F130	CC FM C RCP AND SHROUD	H	B	8	C	1	13140	675	116	45
26	1-CC-TV-102A	F130	2-CC-TV-202A	F130		H	B	8	C	1	13140	675	116	35
27	1-CC-TV-102D	F130	2-CC-TV-202D	F130	CC FM B RCP AND SHROUD	H	B	8	C	1	13140	675	116	40
27	1-CC-TV-102C	F130	2-CC-TV-202C	F130		H	B	8	C	1	13140	675	116	35
28	1-CH-TV-1204A	M120	2-CH-TV-2204A	M120	LETDOWN	H	D	2	B	1	13140	80	275	300
28	1-CH-TV-1204B	M120	2-CH-TV-2204B	M120		H	D	3	B	1	13140	80	275	300
31	1-HC-14	V135	2-HC-15	V135	HC SYSTEM	J	C	2	A	0	0	0	120	5

Table A-2 (Continued)

PEN #	Unit 1		Unit 2		Function	Op Type	Type	Size	Service	Ops/ Cycle	Hours Flow/ Op	Flow (gpm/ scfm)	Temp (°F)	Press (psig)
	Comp ID	Manuf	Comp ID	Manuf										
31	1-HC-TV-105A	M120	2-HC-TV-205A	C635		H	F	2.5	A	0	0	0	120	5
31	1-HC-TV-105B	C635	2-HC-TV-205B	C635		D	F	2.5	A	0	0	0	120	5
31	1-HC-TV-101A	M120	2-HC-TV-201A	V030		H	F	.375	A	0	0	0	120	5
31	1-HC-TV-101B	V030	2-HC-TV-201B	V030		E	F	.375	A	0	0	0	120	5
32	1-WT-465	C684	2-WT-437	V135	WET LAYUP A SG	A	E	3	E	1	8	150	100	100
32	1-WT-468	C684	2-WT-446	V135		A	E	3	E	1	8	150	100	100
33	1-DG-TV-100B	F130	2-DG-TV-200B	F130	PRI DR XFER PMP DISCH	D	F	2	B	1	13140	60	120	55
33	1-DG-TV-100A	F130	2-DG-TV-200A	F130		D	F	2	B	1	13140	60	120	55
34	1-FP-272	M360	2-FP-79	M360	FIRE PROT	F	C	4	G	1	1	50	200	90
34	1-FP-274	C630	2-FP-81	C630		A	A	4	G	1	1	50	200	200
38	1-DA-TV-100B	F130	2-DA-TV-200B	F130	SUMP PMP DISCH	H	F	2	F	18	1	25	100	15
38	1-DA-TV-100A	F130	2-DA-TV-200A	F130		H	F	2	F	18	1	25	100	15
39	1-BD-TV-100B	F130	2-BD-TV-200B	F130	A SG BLOWDOWN	H	F	3	J	6	2190	90	521	818
39	1-BD-TV-100A	F130	2-BD-TV-200A	F130		D	F	3	J	6	2190	90	521	818
40	1-BD-TV-100F	F130	2-BD-TV-200F	F130	C SG BLOWDOWN	H	F	3	J	6	2190	90	521	818
40	1-BD-TV-100E	F130	2-BD-TV-200E	F130		D	F	3	J	6	2190	90	521	818
41	1-BD-TV-100D	F130	2-BD-TV-200D	F130	B SG BLOWDOWN	H	F	3	J	6	2190	90	521	818
41	1-BD-TV-100C	F130	2-BD-TV-200C	F130		D	F	3	J	6	2190	90	521	818
42	1-SA-2	V085	2-SA-123	V085	SERVICE AIR	A	E	2	A	1	2160	120	110	110
42	1-SA-29	P305	2-SA-65	P305		A	F	2	A	1	2160	120	110	110
43	1-IA-149	V080	2-IA-428	V085	AIR MONITOR SAMPLE	F	C	1	A	1	13140	10	105	5
43	1-RM-TV-100A	F130	2-RM-TV-200A	F130		A	F	1	A	1	13140	10	105	5
44	1-RM-TV-100C	F130	2-RM-TV-200C	F130	AIR MONITOR SAMPLE	A	F	1	A	1	13140	10	105	5
44	1-RM-TV-100B	F130	2-RM-TV-200B	F130		A	F	1	A	1	13140	10	105	5
45	1-RC-149	M360	2-RC-162	M360	PRI GR WATER	J	C	3	D	5	8	20	120	110
45	1-RC-TV-1519A	I207	2-RC-TV-2519A	I207		D	D	3	D	11	4	20	120	110

Table A-2 (Continued)

PEN #	Unit 1		Unit 2		Function	Op Type	Type	Size	Service	Ops/ Cycle	Hours Flow/ Op	Flow (gpm/ scfm)	Temp (°F)	Press (psig)
	Comp ID	Manuf	Comp ID	Manuf										
46	1-CH-330	K085	2-CH-332	K085	LOOP FILL	H	C	2	B	1	8	100	130	2500
46	1-CH-FCV-1160	M120	2-CH-FCV-2160	M120		A	F	2	B	1	8	100	130	2500
47	1-IA-55	V080	2-IA-250	V085	INSTRUMENT AIR	F	C	2	A	1	13140	50	110	110
47	1-IA-TV-102B	F130	2-IA-TV-202A	F130		D	F	2	A	1	13140	50	105	5
48	1-VG-TV-100B	F130	2-VG-TV-200B	F130	PRI VENT HEADER	H	F	1.5	A	1	13140	1	120	5
48	1-VG-TV-100A	F130	2-VG-TV-200A	F130		H	F	1.5	A	1	13140	1	120	5
50	1-SI-HCV-1936	M120	2-SI-HCV-2936	M120	N2 TO PRT	D	F	1	A	56	8	30	105	660
50	1-SI-TV-101	F130	2-SI-TV-201	F130		D	F	1	A	50	8	30	100	150
53	1-SI-106	R340	2-SI-132	R340		H	C	1	A	50	8	30	150	2200
53	1-SI-TV-100	F130	2-SI-TV-200	F130		D	F	1	A	50	8	30	100	2000
54	1-DA-39	I207	2-DA-7	I207	PRI VENT POT VENT	D	D	2	A	1	8	5	100	2
54	1-DA-41	I207	2-DA-9	I207		D	D	2	A	1	8	5	100	2
55D	1-LM-TV-100F	M120	2-LM-TV-200F	M120	LEAKAGE MONIT	D	F	.375	A	0	0	0	105	6
55D	1-LM-TV-100E	M120	2-LM-TV-200E	M120		D	F	.375	A	0	0	0	105	6
56A	1-SS-TV-100A	M120	2-SS-TV-200A	M120	PZR LIQ SPACE SAMPLE	H	F	.375	B	15	1	2	653	2235
56A	1-SS-TV-100B	M120	2-SS-TV-200B	M120		H	F	.375	B	15	1	2	653	2235
56B	1-SS-TV-106A	M120	2-SS-TV-206A	M120	HOT LEG SAMPLE	H	F	.375	B	700	1	1	631	2485
56B	1-SS-TV-106B	M120	2-SS-TV-206B	M120		H	F	.375	B	700	1	1	631	2485
56C	1-SS-TV-102A	M120	2-SS-TV-202A	M120	COLD LEG SAMPLE	H	F	.375	B	350	1	1	547	2235
56C	1-SS-TV-102B	M120	2-SS-TV-202B	M120		H	F	.375	B	350	1	1	547	2235
56D	1-SS-TV-112A	M120	2-SS-TV-212A	M120	SG BLOWDOWN SAMPLE	H	F	.375	J	15	1	5	521	880
56D	1-SS-TV-112B	M120	2-SS-TV-212B	M120		H	F	.375	J	15	1	5	521	880
57A	1-LM-TV-100H	M120	2-LM-TV-200H	M120	LEAKAGE MONIT	D	F	.375	A	0	0	0	105	6
57A	1-LM-TV-100G	M120	2-LM-TV-200G	M120		D	F	.375	A	0	0	0	105	6
57B	1-SS-TV-104A	M120	2-SS-TV-204A	M120	PRT GAS SPACE SAMPLE	H	F	.375	A	30	1	.2	200	50
57B	1-SS-TV-104B	M120	2-SS-TV-204B	M120		H	F	.375	A	30	1	.2	200	50

Table A-2 (Continued)

PEN #	Unit 1		Unit 2		Function	Op Type	Type	Size	Service	Ops/ Cycle	Hours Flow/ Op	Flow (gpm/ scfm)	Temp (°F)	Press (psig)
	Comp ID	Manuf	Comp ID	Manuf										
57C	1-SS-TV-101A	M120	2-SS-TV-201A	M120	PZR VAPOR SPACE SAMPLE	H	F	.375	A	0	0	0	653	2235
57C	1-SS-TV-101B	M120	2-SS-TV-201B	M120		H	F	.375	A	0	0	0	653	2235
60	1-SI-207	V085	2-SI-126	V085	LHSI TO HOT LEGS	H	C	6	B	0	0	0	160	0
60	1-SI-MOV-1890B	A391	2-SI-MOV-2890A	A391		B	E	10	B	0	0	0	195	0
61	1-SI-206	V085	2-SI-128	V085		H	C	6	B	0	0	0	160	0
61	1-SI-MOV-1890A	A391	2-SI-MOV-2890B	A391		B	E	10	B	0	0	0	195	0
62	1-SI-195	V085	2-SI-91	V085	LHSI TO COLD LEGS	H	C	6	B	1	4	1100	160	0
62	1-SI-197	V085	2-SI-105	V085		H	C	6	B	1	4	1100	160	0
62	1-SI-199	V085	2-SI-99	V085		H	C	6	B	1	4	1100	160	0
62	1-SI-MOV-1890C	A391	2-SI-MOV-2890C	A391		B	E	10	B	1	4	1700	195	0
62	1-SI-MOV-1890D	A391	2-SI-MOV-2890D	A391		B	E	10	B	1	4	1700	195	0
63	1-QS-19	S075	2-QS-22	S075	QS PUMP B DISCH	J	C	8	A	0	0	0	45	0
63	1-QS-MOV-101B	C684	2-QS-MOV-201B	C684		B	E	8	A	0	6	0	45	0
64	1-QS-11	S075	2-QS-11	G075	QS PUMP A DISCH	J	C	8	A	0	0	0	45	0
64	1-QS-MOV-101A	C684	2-QS-MOV-201A	C684		B	E	8	A	0	6	0	45	0
66	1-RS-MOV-100A	A200	2-RS-MOV-200A	V085	CASING COOLING TO RS	B	E	8	B	0	0	0	45	95
66	1-RS-MOV-101A	A200	2-RS-MOV-201A	C684		B	E	6	B	0	0	0	45	95
67	1-RS-MOV-100B	V085	2-RS-MOV-200B	V085	CASING COOLING TO RS	B	E	8	B	0	0	0	45	95
67	1-RS-MOV-101B	A200	2-RS-MOV-201B	A200		B	E	6	B	0	0	0	45	95
70	1-RS-27	C684	2-RS-30	S075	B RS PUMP DISCH	J	C	10	A	0	0	0	150	0
70	1-RS-MOV-156B	A200	2-RS-MOV-256B	A200		B	E	10	A	0	0	0	150	0
71	1-RS-18	C684	2-RS-20	S075	A RS PUMP DISCH	J	C	10	A	0	0	0	150	0
71	1-RS-MOV-156A	C684	2-RS-MOV-256A	A200		B	E	10	A	0	0	0	150	0

Table A-2 (Continued)

PEN #	Unit 1		Unit 2		Function	Op Type	Type	Size	Service	Ops/ Cycle	Hours Flow/ Op	Flow (gpm/ scfm)	Temp (°F)	Press (psig)
	Comp ID	Manuf	Comp ID	Manuf										
79	1-SW-MOV-103D	A180	2-SW-MOV-203D	A180	SW TO (103'S) AND SW FROM (104'S) RSHX'S	B	B	16	G	0	0	0	95	0
80	1-SW-MOV-103C	A180	2-SW-MOV-203C	A180		B	B	16	G	0	0	0	95	0
81	1-SW-MOV-103B	A180	2-SW-MOV-203B	A180		B	B	16	G	0	0	0	95	0
82	1-SW-MOV-103A	A180	2-SW-MOV-203A	A180		B	B	16	G	0	0	0	95	0
83	1-SW-MOV-104D	A180	2-SW-MOV-204A	A180		B	B	16	G	0	0	0	140	0
84	1-SW-MOV-104C	A180	2-SW-MOV-204B	A180		B	B	16	G	0	0	0	140	0
85	1-SW-MOV-104B	A180	2-SW-MOV-204C	A180		B	B	16	G	0	0	0	140	0
86	1-SW-MOV-104A	A180	2-SW-MOV-204D	A180		B	B	16	G	0	0	0	140	0
89	1-VP-12	P032	2-VP-24	M360	AIR EJECTOR VENT	F	C	6	H	4	8	4	100	10
89	1-SV-TV-103	F130	2-SV-TV-203	F130		H	F	6	H	4	8	4	100	1
90	1-HV-MOV-100C	F130	2-HV-MOV-200C	F130	CONTAINMENT PURGE VENTILATION EXHAUST	B	B	36	A	1	2160	11000	100	9
90	1-HV-MOV-100D	F130	2-HV-MOV-200D	F130		B	B	36	A	1	2160	11000	100	9
90	1-HV-MOV-101	F130	2-HV-MOV-201	F130		B	B	8	A	0	0	0	100	9
91	1-HV-MOV-100A	F130	2-HV-MOV-200A	F130	CONTAINMENT PURGE VENTILATION SUPPLY	B	B	36	A	1	2160	11000	100	9
91	1-HV-MOV-100B	F130	2-HV-MOV-200B	F130		B	B	36	A	1	2160	11000	100	9
91	1-HV-MOV-102	F130	2-HV-MOV-202	F130	USED TO BREAK VACUUM	B	B	18	A	1	8	2500	100	5
92	1-HC-TV-104A	C635	2-HC-TV-204A	C635	CV PUMP SUCT	H	F	2.5	A	0	0	0	120	0
92	1-HC-TV-104B	C635	2-HC-TV-204B	C635		D	F	2.5	A	0	0	0	120	0
92	1-CV-TV-150C	F130	2-CV-TV-250C	F130		H	F	2	A	900	1	62	105	6
92	1-CV-TV-150D	F130	2-CV-TV-250D	F130		D	F	2	A	900	1	62	105	6
93	1-HC-TV-106A	C635	2-HC-TV-206A	C635	CV PUMP SUCT	H	F	2.5	A	1	8	50	120	5
93	1-HC-TV-106B	C635	2-HC-TV-206B	C635		D	F	2.5	A	1	8	50	120	2
93	1-CV-TV-150A	F130	2-CV-TV-250A	F130		H	F	2	A	900	1	62	105	6

Table A-2 (Continued)

PEN #	Unit 1		Unit 2		Function	Op Type	Type	Size	Service	Ops/ Cycle	Hours Flow/ Op	Flow (gpm/ scfm)	Temp (°F)	Press (psig)
	Comp ID	Manuf	Comp ID	Manuf										
93	1-CV-TV-150B	F130	2-CV-TV-250B	F130		D	F	2	A	900	1	62	105	6
94	1-CV-TV-100	F130	2-CV-TV-200	F130	CONT VAC EJECTOR SUCTION	H	B	8	A	2	8	2500	105	6
94	1-CV-4	P032	2-CV-4	P032		A	E	8	A	2	8	2500	105	6
97A	1-SS-TV-103A	M120	2-SS-TV-203A	M120	RHR LIQUID SAMPLE	H	F	.375	B	6	1	1	350	350
97A	1-SS-TV-103B	M120	2-SS-TV-203B	M120		H	F	.375	B	6	1	1	350	350
97B	1-LM-TV-100B	M120	2-LM-TV-200B	M120	LEAKAGE MONIT	D	F	.375	A	2	0	0	105	0
97B	1-LM-TV-100A	M120	2-LM-TV-200A	M120		D	F	.375	A	2	0	0	105	0
97C	1-RC-176	K085	2-RC-143	K085	PZR DEAD WT CALIBRATOR	A	G	.13	A	0	0	0	150	2235
97C	1-RC-178	K085	2-RC-145	K085		A	G	.13	A	0	0	0	150	2235
98A	1-HC-TV-100A	V030	2-HC-TV-200A	V030	HC SYSTEM	E	F	.375	A	0	0	0	120	5
98A	1-HC-TV-100B	V030	2-HC-TV-200B	V030		E	F	.375	A	0	0	0	120	5
98B	1-HC-TV-108A	V030	2-HC-TV-208A	V030	HC SYSTEM	E	F	.375	A	0	0	0	120	5
98B	1-HC-TV-108B	V030	2-HC-TV-208B	V030		E	F	.375	A	0	0	0	120	5
100	1-WT-488	C684	2-WT-438	V135	WET LAYUP B SG	A	E	3	E	1	8	150	100	100
100	1-WT-491	C684	2-WT-447	V135		A	E	3	E	1	8	150	100	100
103	1-RP-28	I207	2-RP-7	I207	REFUEL PURIF INLET	D	D	6	B	4	8	400	140	50
103	1-RP-26	I207	2-RP-84	I207		D	D	6	B	4	8	400	140	50
104	1-RP-6	I207	2-RP-6	I207	REFUEL PURIF OUTLET	D	D	6	B	4	8	400	30	25
104	1-RP-8	I207	2-RP-50	I207		D	D	6	B	4	8	400	30	25
105A	1-LM-TV-100D	M120	2-LM-TV-200D	M120	LEAKAGE MONIT	D	F	.375	A	2	0	0	105	0
105A	1-LM-TV-100C	M120	2-LM-TV-200C	M120		D	F	.375	A	2	0	0	105	0
105B	1-HC-TV-102A	V030	2-HC-TV-202A	V030	HC SYSTEM	D	F	.375	A	0	0	0	120	5
105B	1-HC-TV-102B	V030	2-HC-TV-202B	V030		E	F	.375	A	0	0	0	120	5

Table A-2 (Continued)

PEN #	Unit 1		Unit 2		Function	Op Type	Type	Size	Service	Ops/ Cycle	Hours Flow/ Op	Flow (gpm/ scfm)	Temp (°F)	Press (psig)
	Comp ID	Manuf	Comp ID	Manuf										
105C	1-LM-TV-101D	M120	2-LM-TV-201D	M120	LEAKAGE MONIT SEALED REF	D	F	.375	A	1	0	0	105	0
105C	1-LM-TV-101A	M120	2-LM-TV-201A	M120		D	F	.375	A	1	0	0	105	0
105D	1-LM-TV-101B	M120	2-LM-TV-201B	M120	LEAKAGE MONIT SEALED REF	D	F	.375	A	1	0	0	105	0
105D	1-LM-TV-101C	M120	2-LM-TV-201C	M120		D	F	.375	A	1	0	0	105	0
106	1-SI-TV-1842	M120	2-SI-TV-2842	M120	SI TEST LINE	D	F	.75	B	42	7	15	120	660
106	1-SI-TV-1859	M120	2-SI-TV-2859	M120		D	F	.75	B	42	7	15	120	660
108	1-WT-511	C684	2-WT-439	V135	WET LAYUP C SG	A	E	3	E	1	8	150	100	100
108	1-WT-514	C684	2-WT-448	V135		A	E	3	E	1	8	150	100	100
109	1-HC-18	V135	2-HC-20	V135	HC SYSTEM	J	C	2	A	1	8	50	120	5
109	1-HC-TV-103A	V030	2-HC-TV-203A	V030		E	F	.375	A	0	0	0	120	5
109	1-HC-TV-103B	V030	2-HC-TV-203B	V030		E	F	.375	A	0	0	0	120	5
109	1-HC-TV-107A	C635	2-HC-TV-207A	C635		H	F	2.5	A	1	8	50	120	5
109	1-HC-TV-107B	C635	2-HC-TV-207B	C635		D	F	2.5	A	1	8	50	120	5
111D	1-DA-TV-103A	F130	2-DA-TV-203A	C635	POST ACCIDENT SAMPLE RETURN	H	F	2	B	24	1	5	100	15
111D	1-DA-TV-103B	F130	2-DA-TV-203B	C635		D	F	2	B	24	1	5	120	5
112	NOT USED	F130	2-1A-TV-201A	F130	INSTRUMENT AIR	D	F	3	A	0	0	0	110	0
112	NOT USED	F130	2-1A-TV-201B	F130		D	F	3	A	0	0	0	110	0
113	1-SI-90	V085	2-SI-119	V085	HHSI (NORMAL AND ALTERNATE CHG) TO HOT LEGS	H	C	3	B	1	8	600	160	2235
113	1-SI-MOV-1869B	V085	2-SI-MOV-2869B	V085		B	E	3	B	1	8	600	160	2235
114	1-SI-201	V085	2-SI-107	V085		H	C	3	B	1	8	600	160	2235
114	1-SI-MOV-1869A	V085	2-SI-MOV-2869A	V085		B	E	3	B	1	8	600	180	2235

Table A-3. Class Variable Data Codes

MANUF CODE	MANUFACTURER NAME
A180	Allis Chalmers
A200	Aloyco Div / Walworth Co
A391	Anchor / Darling Valve Co
C630	Contromatics Div / Litton Inds
C635	Copes - Vulcan Inc
C684	Crane Valve Products / Crane Co
F130	Fisher Controls Co Inc
G075	General Dynamics
I207	ITT Grinnell
K085	Kerotest Mfg Corp
M120	Masoneilan International Inc
M360	Mission Drilling Prod Div / TRW Inc
P032	Pacific Valves / Mark Controls Corp
P305	William Powell Co
P340	Henry Pratt Co
S075	Schutte and Koerting Co (Ametek Inc)
V030	Valcor Engineering Corp
V080	Velan Engineering Corp
V085	Velan Valve Corp
V135	Henry Vogt Machine Co
W030	Walworth Co

OP TYPE CODE	VALVE OPERATOR TYPE
A	Manual
B	Electric Motor/Servo
D	Pneumatic
E	Solenoid
F	Float
H	Mechanical -AP to Open
J	None (check valves)

TYPE CODE	VALVE TYPE
A	Ball
B	Butterfly
C	Check
D	Diaphragm
E	Gate
F	Globe
G	Needle

SERVICE CODE	SERVICE
A	Air/Gas
B	Borated Water
C	Chromated Water
D	Clean Water
E	Condensate
F	Dirty Water
G	Service Water
H	Steam
I	Lake/River Water
J	Steam Generator Water/Chemicals

predictive of time between maintenance events. In this procedure, the emphasis was on continuous measures of valve performance: size, operations per operating cycle, hours of flow per operating cycle, flow, temperature, and pressure. In step-wise procedures, variables are included in the model one at a time. At each step, the variable which maximized the r^2 value of the model was retained, and the model's ability to fit the dependent data was assessed. The procedure moves forward step-wise in that the initial model utilizes only one independent variable and additional variables are added at each step. Since the step-wise procedure could not utilize censored data, the right censored components were excluded and the interval censored components were assigned a particular maintenance time. Specifically, the interval censored components were assumed to have required maintenance exactly halfway between the inspection which identified a problem and the prior inspection which found no problems. The variables corresponding to hours flow per operating cycle and flow were selected as a result of the step-wise regression. This equation, however, explained only 10.2% of the variability in the maintenance times ($r^2=0.102$). Incorporating additional variables such as size, operations per operating cycle, temperature, and pressure increased the r^2 only marginally ($<1\%$).

The final statistical procedure was a regression analysis which utilized censored data. It was decided to utilize a model with five independent variables: operator type, valve type, type of service, hours flow per operating cycle, and flow. The three descriptive variables were included in the hope of enhancing the model's ability to describe the censored maintenance times. The procedure was performed on the original censored data-set using the five identified variables as independent predictors of maintenance time. The results of this analysis suggested that only operator type and type of service were statistically significant predictors of censored maintenance time ($p<0.05$). Valve type was marginally significant ($p<0.10$). Coefficient estimates for hours flow per

operating cycle and flow were not significantly different from zero ($p>0.10$).

The maximum correlation between the five variables and time until maintenance rate was 26 percent. It appeared that random matches provided a large portion of this correlation. If quantitative values were handled as class variables, no significant change in results occurred. Based on these results, variations in valve performance cannot be predicted based on system and valve physical characteristics. Thus, a generic failure rate could be used in the containment leakage model for the individual component leakage failure rates.

As previously discussed, Figures A-6 and A-7 suggest that the component failure rate decreases versus the time since last maintenance. In the next series of analyses, the North Anna data were analyzed to determine if the failures of components should be modeled as dependent or independent. The two types of dependent failures which were investigated were common mode failures of the same component, and common mode failures of components in the same penetration.⁶

There are 392 components at North Anna that are Type C tested. Of these components, 168 have undergone maintenance to correct leakage problems, with a total of 278 maintenance events, since 1986. Of the 168, 91 components have failed one time, 51 components have failed twice, 21 components have failed three times, 3 components have failed four times, and 2 components have failed five times.

If multiple failures of a component are independent, the probability of two failures of a component is the square of the probability of a single failure of the component. Table A-4 shows the actual and expected number of component failures (assuming independent failures of the components) for two failure cases. These failure cases are defined as (1) any leakage rate causing a maintenance event and (2) component leakage rate of 250 scf/h or higher. The component failure rates per year were calculated by dividing the total number of

component failures by the total number of outages multiplied by 1.5 (assuming an 18-month interval between outages). Numeric simulations were then run using these failure rates to determine the average expected number of failed components given the number of outages at each unit. This table shows that the failures of a component are not independent, i.e., once a component has failed, it is more likely to fail again.

Table A-5 shows the actual and expected number of component failures (assuming dependent failures of the components) for the same two cases as Table A-4. The component failure rates per year were determined by running the numeric simulation model described above and adjusting the component failure rates until the expected number of zero failures equaled the actual number. A component beta value was then introduced into the numeric simulation such that if a component failed, the component would fail again with a probability equal to the beta value (i.e., a common mode failure between successive failures of a component). This failure was in addition to any random failures of the component. The component beta value was determined by running the numeric simulation model and adjusting the beta value until the total expected number of failures equaled the actual number. Table A-5 shows that there is a good match between the actual and expected number of failures if a component beta value of approximately 0.34 is used.

Based on a review of the North Anna data, in 29 cases a valve had two or more tests where the as-found leakage rate was 25 scf/h or larger. In 18 of these cases, the tests with these leakage rates were 18 months apart. In 10 cases, the tests were 36 months apart. In one case, the tests were 72 months apart. From these data, it is estimated that if a common mode failure of the component occurs at outage N, 64.3 percent of the time the second failure will be detected at outage N+1, and 35.7 percent of the time, the second failure will be detected at outage N+2.

An evaluation of the penetration common mode failure probability required the use of containment leakage model, and is described in the next section.

A.2.2.4 Test Options Analysis

Because only 6 to 7 years of component leakage rate versus time data (five to six refueling outages) were available for each unit, only limited analysis of Type C test options can be performed directly using historical unit data.

The only testing scheme for which sufficient data exist to permit even limited evaluation is the testing of all components every 36 months unless a component fails a test, in which case it is tested every 18 months until it passes two successive tests. The component maintenances that would not have been performed under this testing scheme were identified and removed from the leakage-rate data-base, and this data-base was evaluated to determine the new North Anna unit containment leakage rates over time. While several valves that were leaking at an indeterminable rate would not have been detected for an additional 18 months, there was no significant change in the overall containment leakage rates, and no change in the historical probability of exceeding L_a .

Based on the penetration configuration data and the data in Table A-5, a containment leakage-rate model was created to evaluate selected test scheme options.⁷ This model assumes that all components have a constant failure frequency of $1.3E-2$ per year and a probability (component beta value) of 0.34—such that if the component fails at outage N, the component will fail again at outage N+1 or N+2. Based on the North Anna data, 64.3 percent of these second failures will occur at outage N+1 and 35.7 percent will occur at outage N+2. Failure of a component is defined as the component leaking at a rate of 250 scf/h or greater.

Table A-6 shows the probabilities of indeterminable containment leakage paths for the

Table A-4. Actual Versus Expected Number of Multiple Valve Failures Assuming Independent Failures

# Failures of Component	Failure = Any Leakage of Component Requiring Maintenance		Failure = Leakage Rate of Component \geq 250 scf/h	
	Actual	Expected*	Actual	Expected**
0	224	184	352	338
1	91	149	26	50
2	51	50	11	3
3	21	9	3	0.1
4	3	0.8	0	0
5	2	0.05	0	0
6	0	0	0	0

* Assuming independent failures of components, failure rate = $8.60E-2$ /yr per component.

** Assuming independent failures of components, failure rate = $1.76E-2$ /yr per component.

Table A-5. Actual Versus Expected Number of Multiple Valve Failures Assuming Dependent Failures

# Failures of Component	Failure = Any Leakage of Component Requiring Maintenance		Failure = Leakage Rate of Component \geq 250 scf/h	
	Actual	Expected*	Actual	Expected**
0	224	224	352	352
1	91	95	26	28
2	51	46	11	9
3	21	19	3	2.7
4	3	6	0	0.7
5	2	1.6	0	0.2
6	0	0.2	0	0

* Assuming dependent failures of components, failure rate = $6.46E-2$ /yr per component, component beta value = 0.34.

** Assuming dependent failures of components, failure rate = $1.29E-2$ /yr per component, component beta value = 0.34.

Table A-6. Probability of Indeterminate Containment Leakage Paths for Test Scheme Options

Probability of Having N Indeterminable Containment Leakage Paths														
TEST SCHEME OPTION	PENETRATION COMMON MODE FAILURE PROBABILITY	AVERAGE NUMBER OF COMPONENTS IN FAILED STATE PER OUTAGE	FRACTION OF COMPONENTS TESTED PER OUTAGE	N=0	N=1	N=2	N=3	N=4	N=5	N=6	N=7	N=8	N=9	N=10+
1	0	5.66	1.00	0.9183	7.81E-2	3.49E-3	1.01E-4	2.00E-6	0	0	0	0	0	0
1	5.5E-2	6.08	1.00	0.7319	2.23E-1	3.94E-2	4.95E-3	4.98E-4	3.66E-5	3.12E-6	0	0	0	0
2	0	8.06	0.51	0.8413	1.45E-1	1.29E-2	8.13E-4	4.00E-5	3.33E-7	0	0	0	0	0
2	5.5E-2	8.65	0.52	0.6220	2.89E-1	7.34E-2	1.31E-2	1.79E-3	2.16E-4	2.50E-5	1.17E-6	0	0	0
3	0	9.11	0.37	0.8019	1.76E-1	2.00E-2	1.53E-3	9.27E-5	4.00E-6	0	0	0	0	0
3	5.5E-2	9.77	0.37	0.5587	3.18E-1	9.78E-2	2.11E-2	3.52E-3	4.83E-4	5.50E-5	6.63E-6	3.90E-7	0	0
4	0	7.39	0.53	0.8645	1.25E-1	9.56E-3	5.16E-4	2.37E-5	0	0	0	0	0	0
4	5.5E-2	7.93	0.53	0.6441	2.77E-1	6.58E-2	1.12E-2	1.50E-3	1.66E-4	1.60E-5	1.17E-6	0	0	0
5	0	7.39	0.53	0.8646	1.25E-1	9.58E-3	4.85E-4	2.13E-5	0	0	0	0	0	0
5	5.5E-2	7.94	0.53	0.6441	2.77E-1	6.60E-2	1.12E-2	1.50E-3	1.63E-4	1.48E-5	1.56E-6	3.90E-7	0	0
6	0	12.13	0.33	0.6702	2.50E-1	6.44E-2	1.31E-2	2.13E-3	2.86E-4	3.13E-5	3.67E-6	0	0	0
6	5.5E-2	13.01	0.33	0.4431	3.18E-1	1.54E-1	5.88E-2	1.90E-2	5.03E-3	1.20E-3	2.42E-4	4.52E-5	8.97E-6	2.34E-6
7	0	21.92	0.17	0.3232	2.88E-1	1.95E-1	1.09E-1	5.18E-2	2.14E-2	7.76E-3	2.48E-3	7.10E-4	1.93E-4	5.67E-5
7	5.5E-2	23.43	0.17	0.1880	2.27E-1	2.03E-1	1.57E-1	1.05E-1	6.21E-2	3.26E-2	1.55E-2	6.62E-3	2.63E-3	1.37E-3

selected test scheme options. The test scheme options evaluated are:

1. Test all components every outage.
2. Skip next test of component if test passed.
3. Skip no tests if pass one test or failed previous test.
Skip two tests if pass two tests.
Skip six tests if pass three tests.
4. Skip no tests if pass one test or failed previous test.
Skip one test if pass two tests.
Skip two tests if pass three tests.
5. Skip no tests if pass one test or failed previous test.
Skip one test if pass two tests.
6. Test every 3rd outage (one test approximately every five years).
7. Test every 7th outage (one test approximately every 10 years).

In Table A-6, two values (0 and 5.5E-2) were used as common mode failure (CMF) probabilities for each penetration. The CMF probabilities were applied such that if one or more components associated with a penetration failed, the penetration would fail.

The CMF probability of 5.5E-2 was selected to result in a probability of approximately 0.73 for zero indeterminable containment leakage paths. The value of 0.73 is based on North Anna's experience of 3 occurrences of indeterminable containment leakage paths in 11 unit outages.

Table A-7 shows the change in incremental risk due to containment leakage⁸ relative to the current test scheme (test scheme option 1) for the selected test scheme options. The values in this table were calculated as:

$$IR(S,p) = \frac{\sum_{N=1}^{\infty} P(S,p,N) \cdot N}{\sum_{N=1}^{\infty} P(1,p,N) \cdot N}$$

where:

IR(S,p) = incremental risk for test scheme option S, penetration common mode failure probability p

P(S,p,N) = probability of having N indeterminable containment leakage pathways for test scheme option S, penetration common mode failure probability p

This equation assumes a linear relationship between risk due to containment leakage and containment leakage rate.

Tables A-8 and A-9 are similar to Tables A-6 and A-7, respectively. In these tables, the component failure rate was reduced by 54 percent to reflect the lower probability of failure seen at North Anna since 1990. This value is based on 14 indeterminable valve leakage failures in the last 5 outages, as opposed to 57 indeterminable valve leakage failures in the 11 outages in the complete data-base. The component beta value and the penetration common mode failure probability are assumed to remain the same as previously determined. As can be seen from Table A-9, there is no significant change in incremental risk compared to Table A-7. This implies that the impact of performance-based testing on incremental risk is driven by the component beta factor rather than the independent component failure rate.

A.3 GRAND GULF ANALYSIS

The Grand Gulf Power Station is comprised of a single boiling water reactor.⁹ Data collected at the power station was similar to that collected at North Anna.

Table A-7. Change in Incremental Risk Due to Containment Leakage Relative to Current Test Scheme for Test Scheme Options

Penetration Common Mode Failure Probability	Test Scheme Option						
	1	2	3	4	5	6	7
0	1.00	2.03	2.59	1.71	1.71	5.00	16.25
5.5E-2	1.00	1.52	1.86	1.41	1.41	2.86	6.97

Based on the insights gained from the North Anna analyses, a more restricted set of analyses was performed on the data gathered from Grand Gulf. No statistical analysis was performed to investigate whether component failure rates could be predicted in terms of the components' physical and usage data. The analyses performed using the Grand Gulf data consisted of the calculation of a valve generic failure rate, the common mode failure probability for the valves, and the penetration common mode failure probability. Using the results of these analyses, the effect on incremental risk due to containment leakage was calculated for the seven test schemes analyzed in the North Anna data analysis.

Table A-10 shows the number of component failures observed at Grand Gulf binned by the types of component failures observed. The types of failures considered were those with an immeasurable leakage rate, failures with a measurable leakage rate, as well as those cases where a component didn't undergo a leakage test before maintenance on that component was performed. Leakage is classified as "immeasurable" when the component leakage rate exceeded the range of the testing equipment. As an example, the first line of Table A-10 shows that two valves had both two measurable leakage failures and two immeasurable leakage failures, and the valves underwent maintenance twice prior to being leakage tested.

Table A-11 presents various statistics related to containment penetration component performance. Based on the information in Tables A-10 and A-11, estimates of the valve independent failure rates were computed and are shown in Table

A-12. The first set of calculations in Table A-12 assumes that all valves which underwent maintenance prior to being leakage tested would not have failed such a test if it had been performed. The second calculation corrects the failure rate for these cases by assuming no knowledge of the state of the valve prior to the maintenance. For the remaining analysis, the latter failure rates were used.

Table A-13 shows the actual versus expected number of valve failures assuming independent valve failures due to measurable as well as immeasurable leakage rate. Two different expected number of valve failures are presented for each case. The first value accounts for tests which were not performed prior to maintenance. The second value is the expected number of failures which would have been expected if all tests had been performed. As can be seen from this table, the expected number of multiple valve failures is lower than the actual number experienced. The latter is due to the assumed independence of failures up to this point.

Table A-14 shows the actual versus expected number of valve failures assuming dependent valve failures for both measurable and immeasurable valve leakage rates. In preparing this table, a component beta factor was introduced such that there was an increase probability of a component failing if it had failed previously. The value of this beta factor was derived in the same manner as performed in the analysis of the North Anna data.

Based on the penetration configuration data and the data in Table A-14, a containment leakage-rate model was created to evaluate selected test

Table A-8. Probability of Indeterminate Containment Leak Paths for Test Scheme Options - Data from 1990 to Present

Test Scheme Option	Penetration Common Mode Failure Probability	Average Number of Components in Failed State per Outage	Fraction of Components Tested per Outage	Probability of Having N Indeterminable Containment Leakage Paths											
				N=0	N=1	N=2	N=3	N=4	N=5	N=6	N=7	N=8	N=9	N=10	N=11+
1	0	3.07	1.00	0.9748	2.48E-2	3.54E-4	2.92E-6	0	0	0	0	0	0	0	0
1	5.5E-2	3.30	1.00	0.8597	1.27E-1	1.24E-2	9.04E-4	5.31E-5	2.08E-6	4.95E-8	9.90E-8	0	0	0	0
2	0	4.41	0.51	0.9487	4.99E-2	1.40E-3	2.92E-5	5.45E-7	0	0	0	0	0	0	0
2	5.5E-2	4.74	0.51	0.8007	1.74E-1	2.27E-2	2.17E-3	1.64E-4	9.06E-6	2.48E-7	1.49E-7	0	0	0	0
3	0	5.01	0.36	0.9343	6.34E-2	2.29E-3	5.97E-5	1.04E-6	4.95E-8	0	0	0	0	0	0
3	5.5E-2	5.39	0.36	0.7600	2.04E-1	3.19E-2	3.63E-3	3.30E-4	2.26E-5	1.24E-6	1.98E-7	0	0	0	0
4	0	4.04	0.52	0.9566	4.24E-2	1.02E-3	1.87E-5	1.49E-7	0	0	0	0	0	0	0
4	5.5E-2	4.35	0.52	0.8100	1.67E-1	2.11E-2	1.98E-3	1.52E-4	8.32E-6	3.47E-7	9.90E-8	0	0	0	0
5	0	4.04	0.52	0.9565	4.24E-2	1.02E-3	1.72E-5	4.95E-8	0	0	0	0	0	0	0
5	5.5E-2	4.35	0.52	0.8100	1.67E-1	2.11E-2	1.97E-3	1.50E-4	8.07E-6	3.96E-7	9.90E-8	0	0	0	0
6	0	6.68	0.34	0.8787	1.11E-1	9.58E-3	6.35E-4	3.51E-5	1.73E-6	0	0	0	0	0	0
6	5.5E-2	7.18	0.34	0.6824	2.45E-1	5.90E-2	1.12E-2	1.74E-3	2.20E-4	2.36E-5	2.57E-6	2.97E-7	0	0	0
7	0	12.34	0.18	0.6575	2.56E-1	6.91E-2	1.46E-2	2.48E-3	3.64E-4	4.58E-5	5.10E-6	1.49E-7	4.95E-8	0	0
7	5.5E-2	13.24	0.18	0.4385	3.16E-1	1.57E-1	6.17E-2	2.02E-2	5.69E-3	1.37E-3	2.99E-4	5.69E-5	9.31E-6	8.91E-7	2.97E-7

Test Scheme Options:

- | | |
|--|---|
| <p>1: Test all components every outage</p> <p>2: Skip next test of component if test passed</p> <p>3: Skip no tests if pass 1 test or failed previous test
Skip 2 tests if pass 2 tests (test approximately every 5 years)
Skip 5 tests if pass 3 tests (test approximately every 10 years)</p> <p>4: Skip no tests if pass 1 test or failed previous test
Skip 1 test if pass 2 tests
Skip 2 tests if pass 3 tests (test approximately every 5 years)</p> | <p>5: Skip no tests if pass 1 test or failed previous test
Skip 1 test if pass 2 tests</p> <p>6: Test every 3rd outage (1 test approximately every 5 years)</p> <p>7: Test every 6th outage (1 test approximately every 10 years)</p> |
|--|---|

Table A-9. Change in Incremental Risk Due to Containment Leakage Relative to Current Test Scheme for Test Scheme Options - Data from 1990 to Present

Penetration Common Mode Failure Probability	Test Scheme Option						
	1	2	3	4	5	6	7
0	1.00	2.07	2.67	1.74	1.74	5.18	17.61
5.5E-2	1.00	1.47	1.81	1.39	1.39	2.62	6.04

Table A-10. Containment Penetration Component Failures

VALVES			
# Tests After Maintenance w/o Test Before Maintenance	# Failures with Immeasurable Leakage Rate	# Maintenances Due to Measurable Leakage Rate	# Valve Occurrences
2	2	2	2
1	0	0	50
2	0	0	20
2	1	2	1
1	0	2	5
0	2	3	1
0	0	0	59
3	0	0	4
0	1	2	3
3	1	1	2
0	0	1	11
0	0	2	2
0	1	3	1
1	0	1	2
0	1	1	2
1	1	1	2
2	1	1	1
2	0	1	2
COMPONENT TYPE D			
0	0	0	2
0	0	1	1
0	0	2	1
1	0	0	1
GASKETS			
0	0	0	2

Table A-11. Component Statistics

Parameter	Value
Time between immeasurable failures	18, 30, 15 months
Total number of valves	170
Total number if immeasurable failures of valves	18
Total number of measurable failures of valves	36
Total number of failures of valves	54
Total number of valves where test was performed after maintenance w/o a test before maintenance	129
Total time period (including 18 months prior to first refueling outage)	86 months
Average time between refueling outages	17.2 months

Table A-12. Valve Failure Rates

Independent Failure Rates		
Exposure	170 valves * 86 months	= 14620 valve-months
	170 valves * 5 outages	= 850 valve-outages
Immeasurable Failures	18/14620	= 1.2E-3 per valve-month
	18/850	= 2.1E-2 per valve-outage
Measurable Failures	36/14620	= 2.5E-3 per valve-month
	36/850	= 4.2E-2 per valve-outage
Total Failures	54/14620	= 3.7E-3 per valve-month
	54/850	= 6.4E-2 per valve-outage
Corrected Failure Rates Accounting For Cases Where Tests Were Performed After Maintenance Without A Test Prior To Maintenance		
Exposure	14620 - 129*17.2	= 12400 valve-months
	850 - 129	= 721 valve-outages
Immeasurable Failures	18/12400	= 1.5E-3 per valve-month
	18/721	= 2.5E-2 per valve-outage
Measurable Failures	36/12400	= 2.9E-3 per valve-month
	36/721	= 5.0E-2 per valve-outage
Total Failures	54/12400	= 4.4E-3 per valve-month
	54/721	= 7.5E-2 per valve-outage

Table A-13. Actual Versus Expected Number of Multiple Valve Failures Assuming Independent Failures

# Failures of Component	Failure = Any Leakage of Component Requiring Maintenance		Failure = Leakage Rate of Component \geq 250 scf/h	
	Actual*	Expected**	Actual*	Expected***
0	133	122.3/115.0****	155	152.8/149.8
1	22	41.6/46.7	12	16.5/19.2
2	13	5.7/7.0	3	0.7/1.0
3	2	0.4/0.6	0	0.0/0.0
4	0	00.0/0.0	0	0.0/0.0

- * Ignores all cases where a valve didn't undergo a leakage test before maintenance.
- ** Assuming independent failures of components, failure rate = $5.0E-2$ /yr per component.
- *** Assuming independent failures of components, failure rate = $1.7E-2$ /yr per component.
- **** First value is expected number of valve failures accounting for the times where a valve didn't undergo a leakage test before maintenance. The second value is the expected number of valve failures assuming all leakage tests were performed prior to valve maintenance.

Table A-14. Actual Versus Expected Number of Multiple Valve Failures Assuming Dependent Failures

# Failures of Component	Failure = Any Leakage of Component Requiring Maintenance		Failure = Leakage Rate of Component \geq 250 scf/h	
	Actual*	Expected**	Actual*	Expected***
0	133	133.1/127.1****	155	155.1/152.5
1	22	24.1/28.6	12	12.2/14.5
2	13	9.3/10.2	3	2.3/2.6
3	2	2.8/3.1	0	0.3/0.4
4	0	0.7/0.8	0	0.0/0.0

- * Ignores all cases where a valve didn't undergo a leakage test before maintenance.
- ** Assuming independent failures of components, failure rate = $3.8E-2$ /yr per component, component beta factor = 0.31.
- *** Assuming independent failures of components, failure rate = $1.4E-2$ /yr per component, component beta factor = 0.17.
- **** First value is expected number of valve failures accounting for the times where a valve didn't undergo a leakage test before maintenance. The second value is the expected number of valve failures assuming all leakage tests were performed prior to valve maintenance.

scheme options. This model assumes that all components have a constant failure frequency of $1.4E-2$ per year and a probability (component beta value) of 0.17; such that if the component fails at outage N, the component will fail again at outage N+1 or N+2. Based on the North Anna data, 64.3 percent of these second failures will occur at outage N+1, and 35.7 percent will occur at outage N+2. These values are consistent with the Grand Gulf data. Failure of a component is defined as the component leaking at an immeasurable rate.

Table A-15 shows the probabilities of indeterminable containment leakage paths for the selected test scheme options. In this table, two values (0 and $6.0E-2$) were used as common mode failure (CMF) probabilities on each penetration. These penetration CMF probabilities were applied such that if one or more components associated with a penetration failed, the penetration would fail with this probability. The CMF probability of $6.0E-2$ was selected to result in a probability of approximately 0.80 for having zero indeterminable containment leakage paths. The value of 0.80 is based on Grand Gulf's experience of 1 occurrence of indeterminable containment leakage paths in 5 unit outages.

Table A-16 shows the change in incremental risk due to containment leakage rate¹⁰ relative to the current test scheme (test scheme option 1) for the selected test scheme options. The values in this table were calculated in the same manner as in the North Anna analysis.

A.4 COMPARISON OF RESULTS

Table A-17 shows a comparison between the containment isolation valve leakage failure rates calculated for North Anna and for Grand Gulf. As can be seen from this table, the independent and the dependent failure rates are comparable between the plants, with Grand Gulf's failure rates being slightly lower. The component beta factors for valve failure with any leakage rates are also comparable. The component beta factor for valve failure with immeasurable leakage rates for Grand Gulf is about half the

corresponding beta factor for North Anna. Whether this is due to an actual difference in the valves between the two plants, or is due to the fact that some of the Grand Gulf components with the worst performance history are also the valves which are being maintained before being leakage-tested (and potentially under-representing the number of multiple valve failures) is unknown.

Table A-18 shows a comparison of changes in incremental risk due to containment leakage rate relative to current test scheme for test scheme options for North Anna and for Grand Gulf. The analysis of alternate testing schemes performed based on the North Anna data showed a strong dependence between the incremental risk impact of the various testing schemes and the component beta factor. While the Grand Gulf component beta factor, for those valves with an immeasurable leakage rate, is lower than that for North Anna, no significant difference in the results was found. For all performance based testing schemes (schemes 2 through 5), the maximum increase in incremental risk was approximately a factor of 3.

A.5 Findings

The following findings regarding Type C testing are made based on the analysis of the North Anna and Grand Gulf data:

- The random failure rates of components cannot be predicted based on system and component physical data. Because of this, the component beta factor (a measure of common mode failure) becomes relatively more important and drives the above results.
- Given a component failure, there is a high probability that the component will fail again in the next two operating cycles. If the component does not fail within two operating cycles, further failures appear to be governed by the random failure rate of the component.
- Of the performance-based testing schemes evaluated, none increase the

probability of containment leakage by more than a factor of approximately 3, and none increase the containment leakage contribution to overall unit risk by more than a few percent.

- Any test scheme considered should require a failed component pass at least two consecutive tests before allowing an extended test interval.

The NUMARC summary did not provide sufficient detail to perform independent quantitative assessment of the leakage-rate experience or to derive component failure beta factors as was done for the North Anna and Grand Gulf data. Qualitatively the NUMARC observations appear to be consistent with the insights derived from the other analyses.

Table A-15. Probability of Indeterminable Containment Leakage Paths for Test Scheme Options

TEST SCHEME OPTION	PENETRATION COMMON MODE FAILURE PROBABILITY	AVERAGE NUMBER OF COMPONENTS IN FAILED STATE PER OUTAGE	FRACTION OF COMPONENTS TESTED PER OUTAGE	Probability of Having N Indeterminable Containment Leakage Paths											
				N=0	N=1	N=2	N=3	N=4	N=5	N=6	N=7	N=8	N=9	N=10+	
1	0	4.24	1.00	0.9523	4.66E-2	1.11E-3	2.11E-5	0	0	0	0	0	0	0	
1	6.0E-2	4.69	1.00	0.8044	1.75E-1	1.88E-2	1.26E-3	7.61E-5	2.19E-6	3.64E-7	0	0	0	0	
2	0	6.15	0.51	0.9026	9.26E-2	4.64E-3	1.60E-4	3.28E-6	0	0	0	0	0	0	
2	6.0E-2	6.80	0.51	0.7187	2.38E-1	3.87E-2	4.00E-3	3.23E-4	1.97E-5	1.46E-6	0	0	0	0	
3	0	7.49	0.37	0.8594	1.30E-1	9.59E-3	4.79E-4	2.08E-5	0	0	0	0	0	0	
3	6.0E-2	8.26	0.37	0.6498	2.81E-1	5.97E-2	8.22E-3	8.38E-4	6.52E-5	5.46E-6	0	0	0	0	
4	0	5.88	0.52	0.9103	8.55E-2	4.06E-3	1.32E-4	5.10E-6	0	0	0	0	0	0	
4	6.0E-2	6.49	0.53	0.7271	2.32E-1	3.67E-2	3.70E-3	2.99E-4	1.86E-5	2.91E-6	3.64E-7	0	0	0	
5	0	5.87	0.52	0.9102	8.57E-2	4.02E-3	1.36E-4	2.91E-6	0	0	0	0	0	0	
5	6.0E-2	6.49	0.53	0.7268	2.32E-1	3.67E-2	3.77E-3	2.85E-4	2.00E-5	2.55E-6	0	0	0	0	
6	0	8.72	0.33	0.8042	1.68E-1	2.46E-2	2.70E-3	2.42E-4	1.24E-5	1.09E-6	0	0	0	0	
6	6.0E-2	9.64	0.33	0.5887	2.94E-1	9.15E-2	2.16E-2	3.99E-3	6.19E-4	7.76E-5	9.11E-6	7.29E-7	0	0	
7	0	15.40	0.17	0.5437	2.86E-1	1.17E-1	3.95E-2	1.08E-2	2.45E-3	4.72E-4	8.01E-5	9.11E-6	7.29E-7	7.29E-7	
7	6.0E-2	16.94	0.17	0.3484	3.00E-1	1.89E-1	9.80E-2	4.26E-2	1.54E-2	4.87E-3	1.31E-3	2.92E-4	5.61E-5	1.35E-5	

A-37

NUREG-1493

Table A-16. Change in Incremental Risk Due to Containment Leakage Rate Relative to Current Test Scheme for Test Scheme Options

Penetration Common Mode Failure Probability	Test Scheme Option						
	1	2	3	4	5	6	7
0	1.00	2.09	3.08	1.92	1.93	4.63	14.27
6.0E-2	1.00	1.52	1.98	1.47	1.47	2.59	5.82

Table A-17. Comparison of Containment Isolation Valve Leakage Failure Rates

Failure Rate	Any Leakage		Immeasurable Leakage Rate	
	Grand Gulf	North Anna	Grand Gulf	North Anna
Independent Rate:	5.0E-2/yr	8.6E-2/yr	1.7E-2/yr	1.8E-2/yr
Dependent Rate:	3.8E-2/yr	6.5-2/yr	1.4E-2/yr	1.3E-2/yr
Component Beta Factor:	0.31	0.34	0.17	0.34

Table A-18. Comparison of Changes in Incremental Risk Due to Containment Leakage Rate Relative to Current Test Scheme for Test Scheme Options

Plant	Penetration Common Mode Failure Probability	Test Scheme Option						
		1	2	3	4	5	6	7
North Anna	0	1.00	2.03	2.59	1.71	1.71	5.00	16.25
Grand Gulf	0	1.00	2.09	3.08	1.92	1.93	4.63	14.27
North Anna	5.5E-2	1.00	1.52	1.86	1.41	1.41	2.86	6.97
Grand Gulf	6.0E-2	1.00	1.52	1.98	1.47	1.47	2.59	5.82

Endnotes

1. The NRC gratefully acknowledges the assistance provided by VEPCO staff, especially Mr. David Heacock and Mr. Marvin Tower.

2. The NRC gratefully acknowledges the assistance provided by Entergy staff, especially Mr. Michael J. Meisner and Mr. Kevin Christian.

3. Each reactor is a Westinghouse 3 loop Pressurized Water Reactor (PWR) rated at 934 MWe, net. The containment for each reactor is a conventionally reinforced concrete structure with a flat base mat and cylindrical walls topped with a hemispheric dome. The inside concrete surfaces are covered with steel liner plates for leakagetightness. Containment design pressure is 45 psig. The containment is designed for operation at subatmospheric pressure and is maintained at about 10 psia when the unit is in service. Free air volume is 1,825,000 cubic feet. Unit 1 was placed in operation in 1978; Unit 2 in 1980. The technical specification L_d for each reactor is 304.4 standard cubic feet per hour (scf/h) (0.10% volume/day).

4. St. Lucie 1, DCS number 8704130251, 3/7/87; penetration leakage rate of 3435 scf/h. St. Lucie 2, DCS number 8907120017, 6/5/89; valve leakage rate of 6710 scf/h. St. Lucie 2, DCS number 9012260091, 11/28/89; valve leakage rate of 1923 scf/h. Dresden 3, DCS number 8512100206, 11/7/85; valve leakage rate of 3026 scf/h. Dresden 3, DCS number 9209240032, 12/7/89; valve leakage rate of 1062 scf/h. Browns Ferry 2, DCS number 8501290100, 9/22/84; valve leakage rate of 1117 scf/h, valve leakage rate of 2687 scf/h. La Salle 1, DCS number 8701070483, 11/5/85; valve leakage rate of 1892 scf/h.

5. Frequency of containment leakage at either Unit 1 or Unit 2 = $211p^2 + 8p^3$, where p is frequency of individual component leakage. This equation was derived as follows:

$$\begin{array}{rcl}
 4 @ & p*((p*p)+(p*p)) & = 4*2p^3 \\
 2 @ & (p+p)*(p+p+p) & = 2*6p^2 \\
 165 @ & p*p & = 165*1p^2 \\
 2 @ & p*(p+p+p) & = 2*3p^2 \\
 14 @ & p*(p+p) & = 14*2p^2 \\
 & \text{-----} & \\
 & & 211p^2+8p^3
 \end{array}$$

where $p*p$ means two valves in series, and $p+p$ means two valves in parallel

6. To limit confusion, the common mode failure probability related to multiple failures of a single component is called the "component beta value." The common mode failure probability related to multiple failures of components in a penetration is called the "penetration common mode failure (CMF) probability."

7. The basic logic of the model is as follows:

- a. Create a time line covering 1000 outages for each component.
- b. Based on failure frequency, flag outages where component fails.
- c. Select penetration CMF probability, apply to time line. If one or more components in a penetration are failed, all components in penetration fail with probability of penetration common mode failure probability.
- d. Select and apply test scheme. If component is failed at test, set component failed at one of next two outages with probability of component beta value.
- e. Count total number of component failures in time line.
- f. For each time point calculate containment leakage rate.
- g. Cycle through above steps N times. $N > 5000$ (gives sample size of $5E6$ outages for each test scheme and penetration common mode failure probability value combination).
- h. Adjust results for number of outages and number of cycles. Print results.

8. See Section 7.1 for a description of risk due to containment leakage rate versus total unit risk.
9. Grand Gulf is a 1142 net MWe BWR which utilizes a Mark III containment.
10. See Section 7.1 for a description of risk due to containment leakage rate versus total unit risk.

APPENDIX B

APPROACH TO ASSESSING RISK IMPACTS

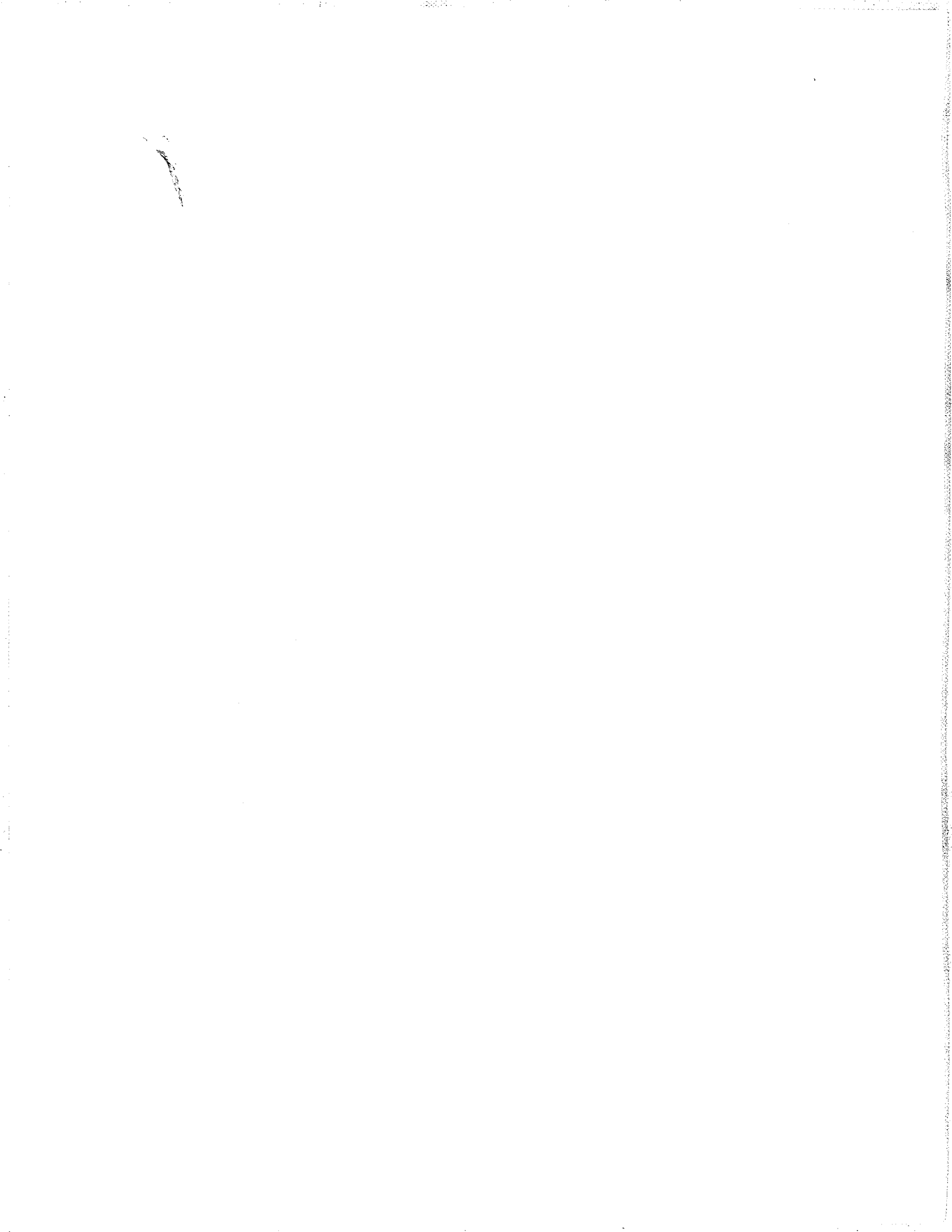

Contents

	<u>Page</u>
B.1 NUREG-1150 Approach	B-1
B.2 NUREG/CR-4330 Update	B-4

Figures

<u>Number</u>	<u>Page</u>
B-1 NUREG-1150 Risk Analysis Process	B-2

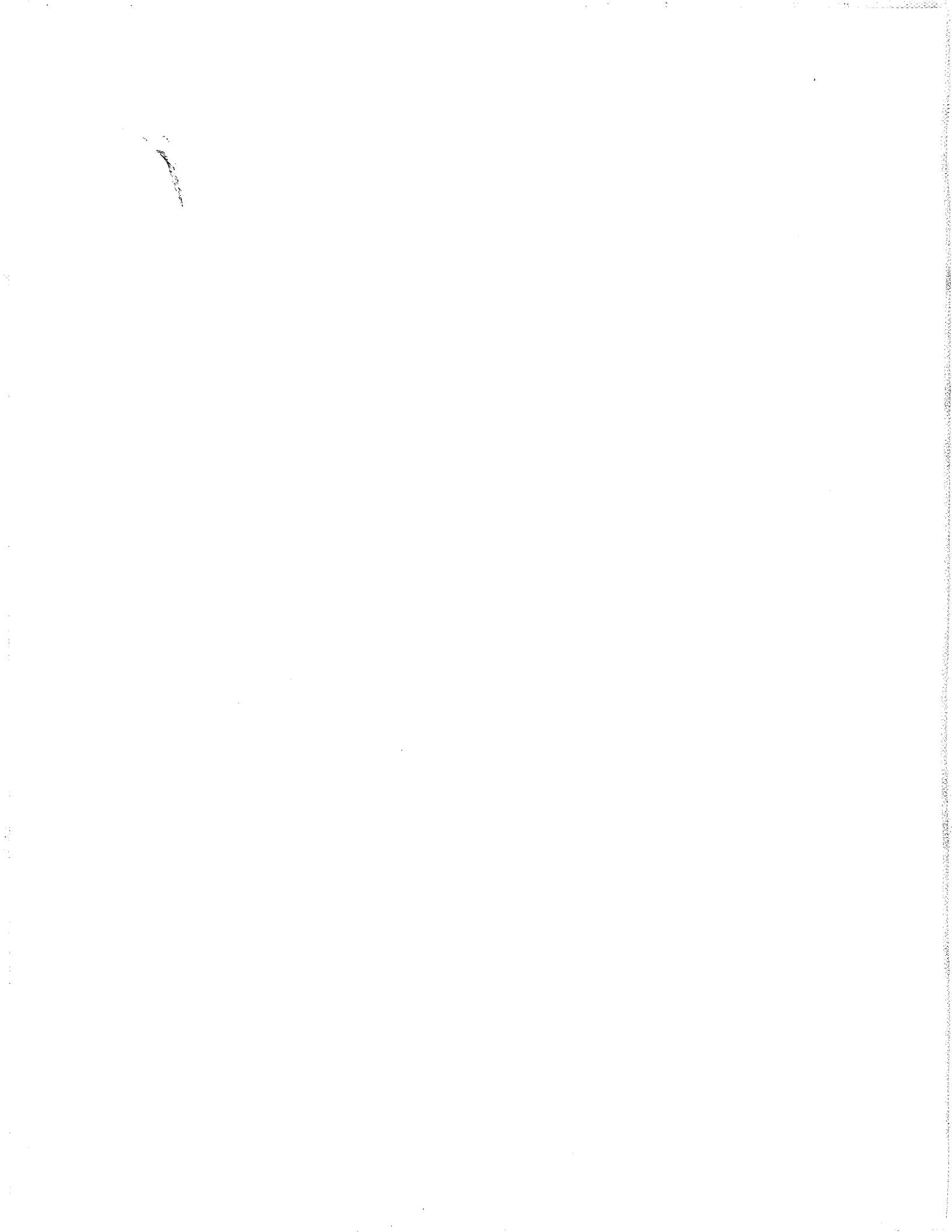

APPENDIX B

APPROACH TO ASSESSING RISK IMPACTS

This appendix provides a more detailed explanation of the risk assessment methodology used in NUREG-1150 (NRC90) and the approach taken in the present study to update the NUREG/CR-4330 (NRC86) results based on NUREG-1150.

B.1 NUREG-1150 APPROACH

The main objective of NUREG-1150 was to provide a current state-of-the-art assessment of severe accident risks for five U.S. nuclear power units with different designs. The five commercial nuclear power units include:

- Surry Power Station, Unit 1: a Westinghouse-designed three-loop pressurized water reactor in a subatmospheric containment building, located near Williamsburg, Virginia
- Peach Bottom Atomic Power Station, Unit 2: a General Electric-designed boiling water (BWR-4) reactor in a Mark I pressure suppression containment, located near Lancaster, Pennsylvania
- Sequoyah Nuclear Power Plant, Unit 1: a Westinghouse-designed four-loop pressurized water reactor in an ice condenser containment building, located near Chattanooga, Tennessee
- Grand Gulf Nuclear Station, Unit 1: a General Electric-designed boiling water (BWR-6) reactor in a Mark III pressure suppression containment, located near Vicksburg, Mississippi
- Zion Nuclear Plant, Unit 1: a Westinghouse-designed four-loop pressurized water reactor in a large, dry containment building, located near Chicago, Illinois.

The study can generally be characterized as consisting of four major analysis steps and an integration step as described below and in Figure B-1.

1. Systems analysis: the determination of the likelihood and nature of accidents that result in the onset of core damage.
2. Accident progression analysis: an investigation of the core damage process, both within the reactor vessel before it fails and in the containment afterwards, and the resultant impact on the containment.
3. Source term analysis: the estimation of the radionuclide transport within the reactor coolant system (RCS) and the containment, and the nature and magnitude of the subsequent releases to the environment.
4. Consequence analysis: the calculation of the off-site consequences, primarily in terms of health effects to the general population.
5. Risk integration: the assembly of the outputs of the previous tasks into an overall expression of risk.

Systems Analysis

The first step is the systems (frequency) analyses. This step identifies the combination of events that can lead to core damage and estimates their frequency of occurrence. Potential accident-initiating events (including

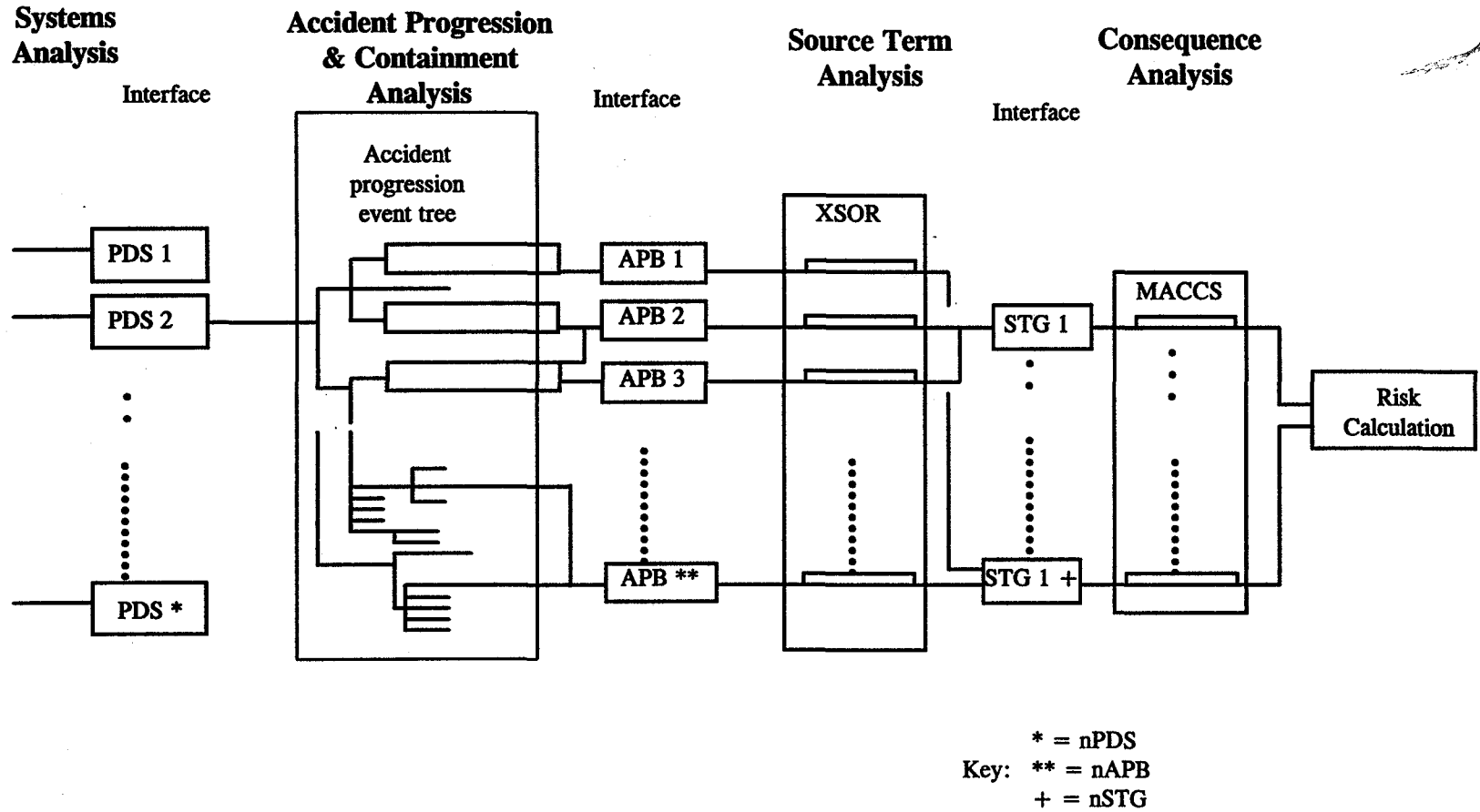

Figure B-1. NUREG--1150 Risk Analysis Process

external events for two units) were examined and grouped according to the required subsequent system response. Once these groups were established, accident sequence event trees were developed to detail the relationships among systems required to respond to the initiating event in terms of potential system successes and failures. The front-line systems in the event trees, and the related support systems, were modeled with fault trees or Boolean logic expressions as required. The core damage sequence analysis was accomplished by appropriate Boolean reduction of the fault trees in the system combinations specified by the event trees. Once the important failure events were identified, probabilities were assigned to each basic event and the accident sequence frequencies were quantified. The accident sequence cut sets were then regrouped into unit damage states (UDS) in which all cut sets were expected to result in a similar accident progression.

Accident Progression Analysis

The second step, the accident progression and containment response analysis, investigated the physical processes affecting the core after an initiating event occurs. In addition, this part of the analysis tracked the impact of the accident progression on the containment building. The principal tool used was the accident progression event tree. The output of the accident progression event tree (APET) was a listing of numerous different outcomes of the accident progression. As illustrated in Figure B-1, these outcomes were grouped into accident progression bins (APBs) that allow the collection of outcomes into groups that are similar in terms of the characteristics that are important to the next stage of the analysis, the source term estimation.

Once the APET was constructed, the probabilities of the paths through the APET were evaluated by EVENTRE. EVENTRE performs the function of grouping similar outcomes into bins. The accidents that are grouped in a single bin are similar enough in terms of timing, energy, and other

characteristics that a single source term estimate suffices for estimating the radiological impact of any of the individual accidents within that bin.

The qualitative product of this step is a set of accident progression bins. Each bin consists of a set of event tree outcomes (with associated probabilities) that have a similar effect on the subsequent portion of the risk analysis, analysis of radioactive material transport. Quantitatively, the product consists of a matrix of conditional failure probabilities, with one probability for each combination of unit damage state and accident progression bin. These probabilities are in the form of probability distributions, reflecting the uncertainties in accident processes.

Source Term Analysis

The next step was the source term analysis. A unit-specific model was developed for each of the five units, with the suffix SOR built into the code name. For example, SURSOR was the source term model for the Surry unit. The results of the source term analysis were release fractions for nine groups of chemically similar radionuclides for each accident progression bin. As with the previous analyses, many results were generated, too many for direct transfer to the next step. The interface in this case was accomplished through the calculation of "partitioned" source term groups. The large number of unit-specific XSOR results (where "X" represents the prefix for the individual unit) were assessed and grouped in terms of early health threat potential and latent health threat potential and by similarity of accident progression as it affects warning times to the surrounding population. The product of this step was the estimate of the radioactive release of a set of source term groups, each with an associated energy content, timing of the release, and duration of release.

Off-site Consequence Analysis

The fourth step was the off-site consequence analysis which was performed with the MACCS (MELCOR Accident Consequence Code System) computer code. The MACCS calculations were

performed for each of the partitioned source terms defined in the previous step. The product of this step of the analysis was a set of off-site consequence measures for each source term group. For NUREG-1150, the specific consequence measures include early fatalities, latent cancer fatalities, population dose (within 50 miles and total), and early as well as latent individual cancer risk for comparison with NRC's safety goals.

Risk Integration

The final stage of the risk analysis assembles the output of the first four steps into an expression of risk:

$$\text{Risk}_{in} = \sum_h \sum_i \sum_j \sum_k f_i(\text{IE}_h) P_n(\text{IE}_h \rightarrow \text{UDS}_i) P_n(\text{UDS}_i \rightarrow \text{APB}_j) P_n(\text{APB}_j \rightarrow \text{STG}_k) C_k$$

where the total risk is represented by summing the product of the probability that the initiating event leads to a unit damage state, given: 1) the frequency of the initiating event 2) the probability that the unit damage state leads to an accident progression bin 3) the probability that the accident progression bin produces a given source term group, and 4) the consequence of the source term group.

B.2 NUREG/CR-4330 UPDATE

The purpose of the NUREG/CR-4330 update is to incorporate the latest PRA results, notably those in NUREG-1150 (NRC90) and related supporting documentation. However, not all of the interim results needed to evaluate the risk were reported in NUREG-1150. Instead, the update presented only a summary of the results. Thus, in order to extract the desired information on the risk contribution of containment leakage, some of the original computer files generated in the preparation of NUREG-1150 were obtained for each of the five units. The following describes the general contents of each file.

Master Bin File: Definitions of the accident progression bins

Frequency File: Frequencies of each of the unit damage states relating to relevant accident progression bins and associated bin probabilities

Consequence File: Expected consequences for each of the source term groups

Pointer File: Relationship between each unit damage state and accident progression bin to its appropriate source term group.

The information extracted from each set of the above files includes the frequencies and expected consequences of each of the source term groups for the following three cases:

1. The base case included all possible combinations of unit damage states, accident progression bins, and source term groups. This case is identical to the results presented in NUREG-1150 and comparison of the present result was used to verify the correct usage of the data files.
2. Combinations with no containment failure or bypass which were used to characterize the risk contribution of the assumed normal containment leakage.
3. The results for isolation failure were used to derive the expected consequences of a pre-existing large leak (0.1 ft²).

Subtracting the contribution of the no containment failure cases (Case 2) from the base case (Case 1) gave the results for zero

containment leakage (Point 1). Case 2 resulted in the risk contribution of normal containment leakage (Point 2). Using the expected consequences for a large leak (Case 3) together with the probability of no containment failure (Case 2) yielded the potential risk contribution of a large pre-existing leak (Point 3).

These three points were plotted as leak rate or leak area versus expected risk and a curve was fitted through them. It was found that a second order polynomial would accurately reproduce the three points. These polynomial fits were then used to interpolate risk impacts of leakages above the nominal values that had been used in the original NUREG-1150 analyses.

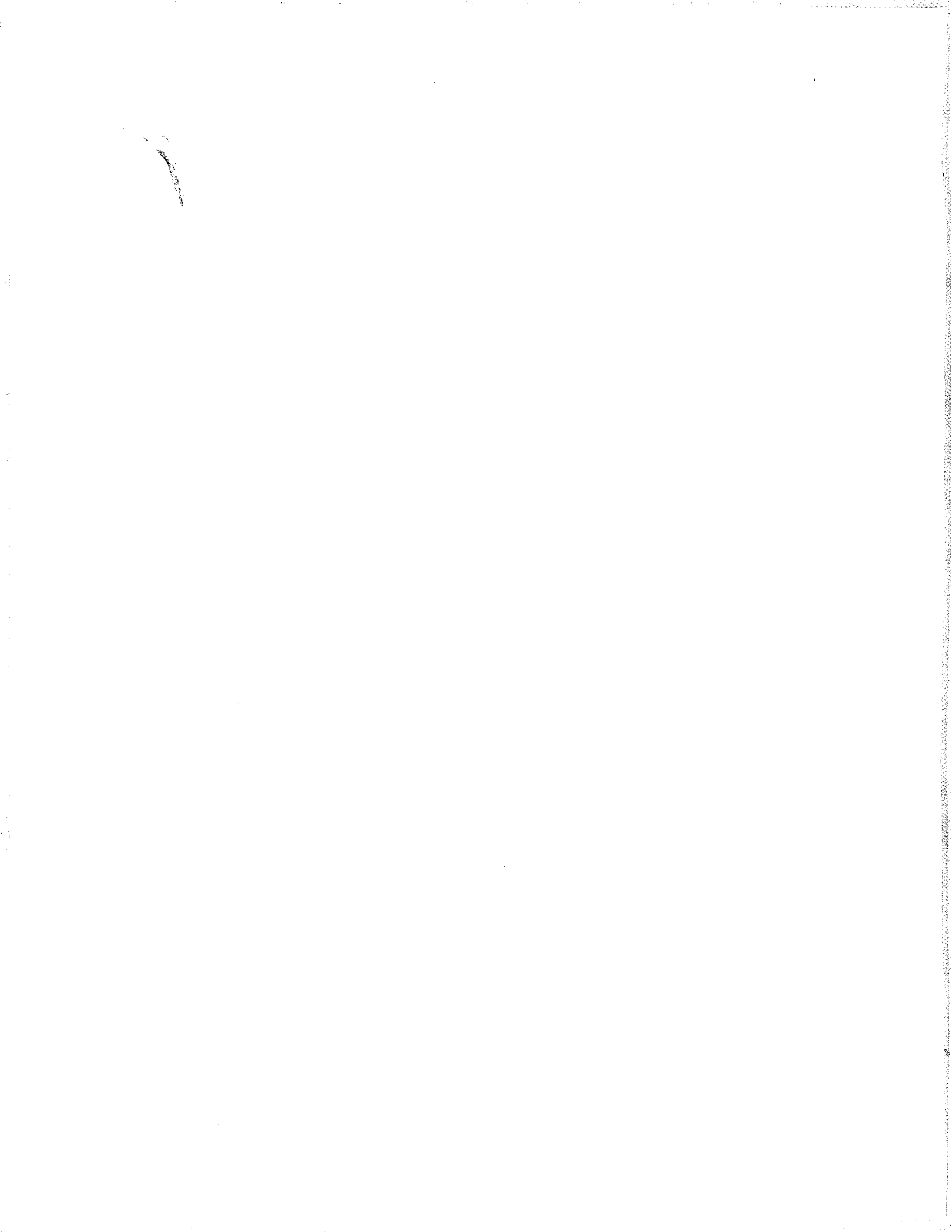

APPENDIX C

CANADIAN AND EUROPEAN OLM AND TYPE A TESTS

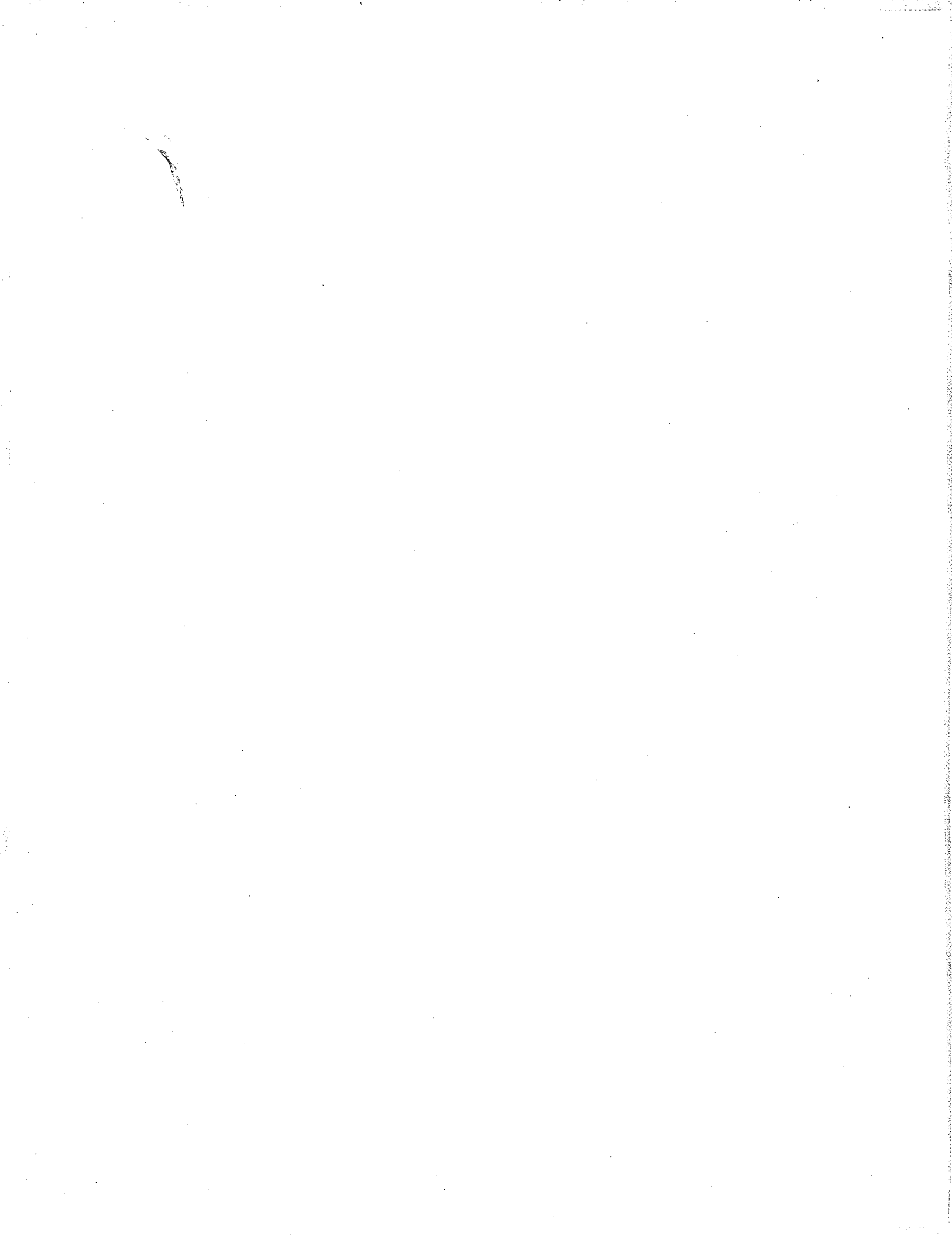

Contents

	<u>Page</u>
C.1 The French On-line Monitoring System (The SEXTEN System)	C-1
C.2 The Belgian On-line Monitoring System	C-2
C.3 Type A Tests in Belgium	C-3
C.4 The Canadian On-line Monitoring System (The TCM System)	C-4

Figures

<u>Number</u>		<u>Page</u>
C-1	Typical Containment Air Pressure Cycle	C-6
C-2	Containment Leak Rate	C-7
C-3	Diagram of the SEXTEN System	C-8
C-4	Leakage-Rate Test Results	C-9
C-5	Temperature Compensation Method (TCM) System	C-10
C-6	Gentilly II Pressure Test for Various Pressure Hold Points	C-11

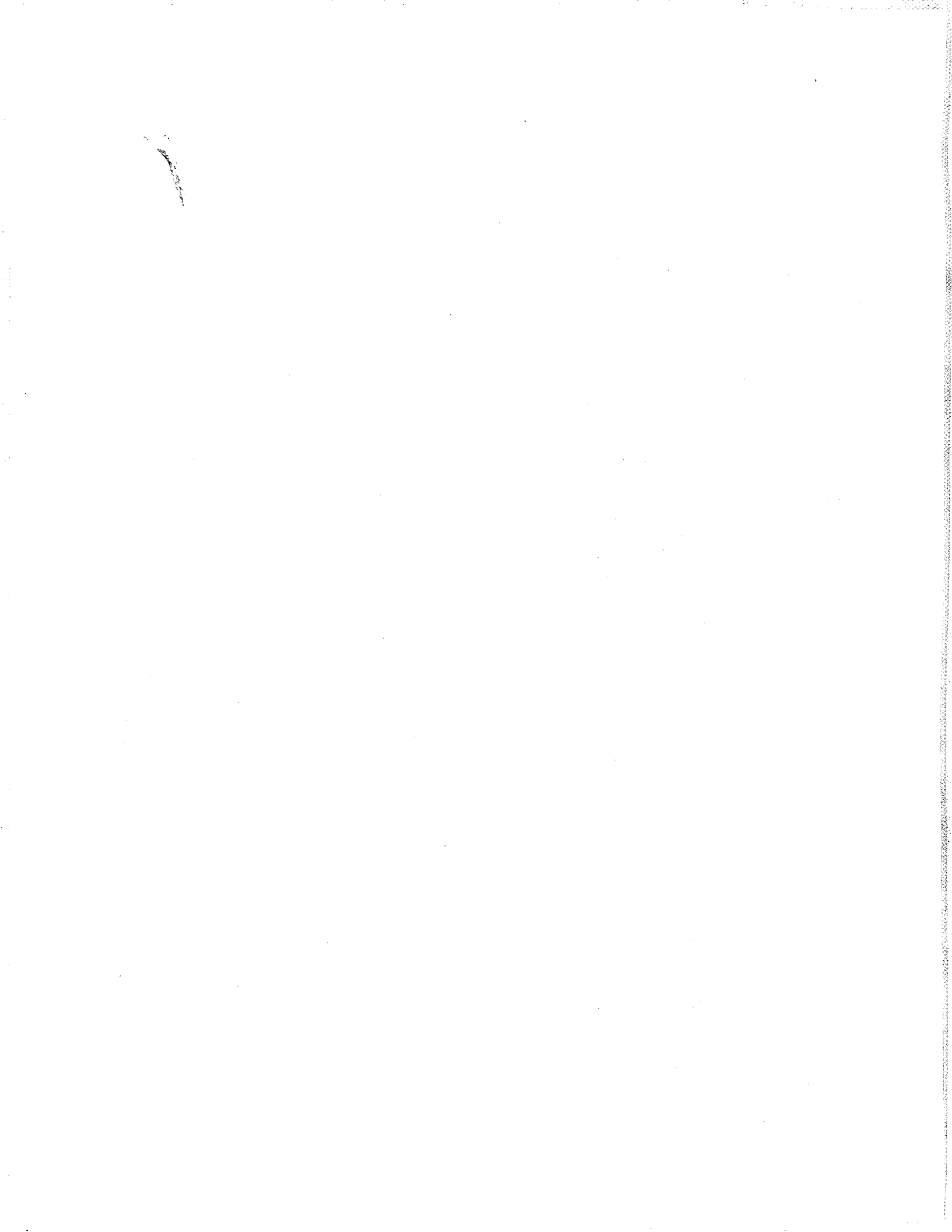

APPENDIX C

CANADIAN AND EUROPEAN OLM AND TYPE A TESTS

C.1 THE FRENCH ON-LINE MONITORING SYSTEM (THE SEXTEN SYSTEM)

Containment leak-tightness is continuously monitored during reactor operations in all of the French PWR plants using the SEXTEN system. The SEXTEN system is also being evaluated by the Swedes for their PWR units.

On-line leakage detection is based on the fact that the containment air pressure goes up and down in a cycle. Air pressure builds up as air from the instrument compressed air distribution system (ICADS) leaks through the air-operated valves inside the containment. When the pressure reaches a set limit, the operator quickly depressurizes the containment and, after that, a new pressurization cycle begins. A typical containment air pressure cycle is shown in Figure C-1. The pressure cycle is about 20 days for a 900MW PWR unit. The amplitude of the cycle is about 100 mbar (1.5 psi).

Leakage from the containment can be calculated by air mass balance. Air mass is found by measuring the average containment partial steam pressure and the absolute air pressures (absolute method). The dry air content of the containment can then be calculated. The leakage rate is calculated by subtracting the ICADS air flow rate from the total dry air content. The average gauge pressure in the containment can be measured every day. Curves such as that shown in Figure C-2 can be obtained. By analyzing these curves, a diagnosis of the containment leak-tightness can be made.

Instrumentation capable of accurately measuring the average temperature and the average partial steam pressure is required as these parameters exhibit large fluctuations during reactor operations. Location of sensors and their weighting for the computation of average values is essential to obtaining accurate results.

SEXTEN system instrumentation is shown in Figure C-3. The following equipment is installed for each containment:

- 10 temperature sensors
- 2 dew point sensors
- 1 absolute pressure transducer
- 1 atmospheric pressure transducer
- 1 flowmeter in the ICAD system

A data acquisition and processing system, which consists of the following components, is shared by two containments:

- 1 data logger (HP 75000 B)
- 1 computer (HP VECTRA 386/25)
- Software
- 1 printer
- 1 plotter

The system operates continuously and provides measurements daily or at the end of each pressurization cycle in the containment. At the operator's request, the air mass inside the containment can be plotted in real time when leaks are being sought. Once it has detected a leakage problem, SEXTEN can be used as an aid to identifying the defective systems or components. The effects on containment leakage rate from closing a particular system or the repair of a particular component can be seen from the real time plotting of containment air mass. The first containment leakage-rate tests in an operating unit performed in 1980 provides a good example. The results of these tests are shown in Figure C-4. The solid line (dM/M) describes the change of air mass in the containment versus time. The slope of this curve represents the containment leakage rate. The curves dT/T_0 , $dP/(P-H)_0$, and $dH/(P-H)_0$ respectively describe the changes of absolute temperature, absolute pressure, and water vapor pressure inside the containment during the test.

During the first phase, the system recorded a decrease in the air mass corresponding to a leakage rate of 21 Nm³/h (742 scf/h) at 52 mbars (0.76 psig) positive pressure. An effort was made to locate the leakage path by closing valves on different penetrations. During Phase 2, with the plant radiation monitoring system closed, the SEXTEN system measured an air ingress into the containment of about 6 Nm³/h (212 scf/h). During Phase 3, the plant radiation monitoring system was back in operation and the SEXTEN system measured a leakage rate of 13 m³/h (459 scf/h) at 37 mbar (0.5 psig) positive pressure. During Phase 4, the service compressed air distribution system (SCADS) was isolated and a change of the dM/M curve was noticeable. During Phase 5, with both the plant radiation monitoring system and the SCADS closed, there was no measurable leakage at 33 mbars (0.49 psig) positive pressure.

In conclusion, the SEXTEN system detected a leakage through the plant radiation monitoring system and an undesirable air in-leakage into the containment from the SCADS. This first test, therefore, demonstrated that integrated containment leakage rate could be measured during reactor operation with an accuracy sufficient to detect leakage problems that may occur.

The SEXTEN system has been installed in all of the French reactors since 1985 and has accumulated 250 reactor-years of experience. The system has detected and located containment leaks during reactor operation. These leaks are generally located in the systems that provide a connection between the containment air and the outside atmosphere. Examples of such systems are plant radiation monitoring system, nuclear island vent and drain system, containment purge system, and containment atmosphere monitoring system.

Detailed descriptions of the SEXTEN system are provided in EDF93 and EDF89.

C.2 THE BELGIAN ON-LINE MONITORING SYSTEM

The operation of the Belgian On-Line Monitoring System described below is summarized from details provided in reference BOE90.

In normal operation, the pressure in the containment tends to increase due to leakage from the compressed air system. If the flow of incoming air, the pressure, the temperature, and the humidity in the building are measured, the leakage rate can be calculated.

For a typical test, the pressure is allowed to go from -20 to +60 mbar (-0.52 to +0.88 psi). The minimum pressure range should be between 0 and +50 mbar (0 to +0.74 psi) if reasonable accuracy is to be achieved. The pressure increase rate is normally in the range of 0.5 to 1 mbar/h (0.075 to 0.015 psi/h) and, therefore, a test would last several days. A minimum test duration of 50 hours is needed to obtain sufficient data points. If during the test, the atmospheric pressure drops suddenly and the maximum differential pressure is reached before 50 h, the test should be performed again.

All parameters are measured every 30 seconds. The values are averaged over 15 minutes to give one data point. A typical test gathers 200 to 400 data points. The data points are plotted in a graph showing the leakage rate as a function of the square root of the differential pressure between the reactor building and the auxiliary building.

During the test, care should be taken not to disturb the conditions in the containment. Airlock movements should be avoided as much as possible. The ventilation and cooling of the containment should be very stable. Any disturbances in the temperature distribution in the containment will lead to a greater spreading of the data points.

The tests are conducted using the same instrumentation as the Type A tests, with the addition of the flow meters on the compressed

air system. To save a penetration, the pressure difference between the containment and the auxiliary building is not measured directly, but is computed from absolute pressure measurements.

The temperature is measured using 30 sensors to provide a more reliable average temperature. The humidity is measured by 5 to 10 probes. In the absolute method, the air mass change in the containment is computed from the absolute pressure, the temperature, and the humidity. In the reference method, the air mass change is computed from the absolute pressure, the pressure difference between the reference vessel and the containment, and the humidity. For both methods, the free volume of the containment must be known.

The difference between the air mass change computed from the parameters in the containment, and the air mass change measured by the flow meters on the compressed air system, is the leakage flow of the containment. This leakage is then plotted versus the square root of the differential pressure between the containment and the auxiliary building.

A straight line is then computed by the least squares method. Conventionally, the leakage rate is expressed as the difference between the value at 60 mbar (0.88 psi) and the value at 0 mbar, and is noted as Q_{f60} . The value at 0 mbar (Q_{f0}) should theoretically be zero, but is nearly never so for two reasons:

- Errors in the instrumentation and errors in estimating the free volume of the containment.
- An unaccounted inflow or outflow of gas, which is independent of the pressure in the containment

The standard deviation is also computed and is a measure of the spreading of the data points. This spreading comes from instrumentation errors and from errors in weighing temperature and humidity measurements. For these reasons, it is important to maintain the temperature and

humidity in the containment as stable as possible.

The standard deviation typically lies between 0 and 2 Nm³/h (0 and 71 scf/h). One should not place too much emphasis on the value of the leakage rate because the error is of the same magnitude as the value measured.

C.3 TYPE A TESTS IN BELGIUM

In conjunction with on-line monitoring of containment leakage during reactor operations, Type A tests are conducted once in 10 years at reduced pressure (P_a) of not less than half of the peak accident pressure ($0.5 P_p$) (BEL86, BEL86A). According to the Belgians, the disadvantages of testing at P_a are:

- The P_a pressure is not representative of the real pressure in the containment after an accident because of the margins of conservative assumptions and the depressurization effects of the containment cooling systems
- The duration of testing at P_a is considerably longer than testing at lower pressure—more time for preparation, pressurization, and depressurization
- Testing at higher pressure increases the risk of fires, plus difficulty of fighting the fire should it occur, and the potential for damaging equipment in the containment

Test Acceptance Criterion

To conduct the tests, the Belgians use the following criterion:

$$L_{tm} \leq 0.75 L_a (P_i/P_a)$$

where,

L_{tm} is the measured containment leakage rate at P_i

L_a (percent/24 hours) is the maximum allowable leakage rate

at pressure P_a as specified in the technical specifications or associated bases, and as specified for periodic tests in the operating license

This test acceptance criterion is different than the one specified by Appendix J to 10 CFR Part 50. According to Appendix J, the acceptance criterion for reduced pressure tests conducted at pressure P_t , which is not less than $0.5 P_a$, is:

$$L_{tm} < 0.75 L_t$$

where,

L_t (percent/24 hours) is the maximum allowable leakage rate at pressure P_t and is derived from the pre-operational test data as follows:

$$\begin{aligned} L_t &< L_a (L_{tm}/L_{am}) \\ \text{if } L_{tm}/L_{am} &\leq 0.7 \\ L_t &= L_a \text{ SQRT}(P_t/P_a) \\ \text{if } L_{tm}/L_{am} &> 0.7 \end{aligned}$$

where,

L_{am} is the total measured containment leakage rate at pressure P_a

The Belgian criterion is independent of the leakage rates measured during the pre-operational leakage test. Errors in the measured values of L_{tm} and L_{am} would become greater as the actual leakage rate becomes smaller. The Belgian criterion is more conservative for laminar flow along the leakage paths as the use of $\text{SQRT}(P_t/P_a)$ is less conservative than (P_t/P_a) in laminar flow.

Duration Criterion

In Belgium, Type A tests are performed using both the absolute method and the reference vessel method. These two methods are totally independent, and their results can be used for mutual validation. The advantages of using two independent methods are that the duration of leakage tests may be shortened and the calibrated

leakage test to verify the accuracy of the leakage-rate measurement may not be necessary.

The Belgians have adopted the following test duration criterion: The test can be discontinued if, over a period of at least 8 hours and with at least 30 consecutive measurement points, both measurement techniques find a leakage rate that meets the test acceptance criterion.

Concordance Criterion

It is not necessary to perform a verification test (i.e., calibrated leakage test) if, at the end of the test period, the difference between the measured leakage rates derived from each method over the last 8 hours is:

$$< 0.25 L_t' - 0.1 L_{tm}'$$

where,

$L_t' = L_a (P_t/P_a)$ and L_{tm}' is the mean value of the two leakage rates.

Calibrated Leakage Test

If the above concordance criterion is not met or if only one method is used, a calibrated leakage test is mandatory. In a calibrated leakage test, a known flow rate or step mass change is introduced to the containment and the leakage rate or mass change measured by the instrumentation is determined and compared with the known value.

C.4 THE CANADIAN ON-LINE MONITORING SYSTEM (THE TCM SYSTEM)

Canada's Hydro-Quebec began the development of an OLM system in 1987. The Canadian OLM system uses the Temperature Compensation Method (TCM). The TCM uses an extensive network of tubing as a reference volume and a second independent tubular network for humidity sampling (CAN94). The system is shown in Figure C-5.

The appropriate reference volume was obtained by installing a leak-tight network of copper tubing, about 0.75 km (0.47 mile), throughout all significant volumes of the reactor building.

The tubing is sized and routed in such a way that the reference volume fraction contained within each room is proportional to the volume of the room.

The differential pressure between the reference volume and the reactor building is a critical parameter. The test procedure requires that the leak-tightness of the tubular network reference volume be verified. After the leak-tightness verification, the reference volume and the reactor building internal pressures are equilibrated and then isolated from each other. A decrease in the differential pressure can be directly related to the reactor building leakage, as the reference volume continuously replicates the overall reactor building temperature.

The tubular network for humidity sampling includes two hygrometers to obtain the "weighted" reactor building dew point measurements, and a suction pump and flowmeters for verification of the loop calibration. The tubular network is sized, routed, and designed with orifice flow control to ensure the intake of the correct amount of air from each of the 11 reactor building zones defined for "weighting" purposes.

In October 1992, containment integrity testing at low pressure (3 kPa(g) nominal) and at 100% full power was performed at Gentilly-2 Nuclear Power Station. The test methodology and precision were confirmed and the system was declared in-service for on-line containment integrity verification.

The 1992 test and the following test in June 1993 indicated higher than the expected reactor building leakage rate. A containment bypass to the spent fuel discharge bay due to a valve alignment problem was subsequently discovered. Four additional tests performed in 1993 and 1994 have demonstrated consistent leakage-rate results. Thus, the usefulness of the system to detect a degradation of containment leak-tightness was demonstrated. The outstanding feature of the system is the accuracy of better than 5% of the measured leakage rate under typical conditions.

The secondary goal of the Gentilly-2 testing program was to correlate leakage measurements

from the on-line, low-pressure test results to the containment leakage criteria at high pressure (124 kPa(g)), i.e., 0.5% of reactor building volume per day (% V/D). A complex non-linear extrapolation equation is required to transform a low-pressure test leakage rate to the equivalent high-pressure leakage rate. This equation is heavily dependent on the " R_L " factor which represents the ratio of laminar to turbulent flow. Reactor building leakage is characterized by a combination of turbulent and laminar gas flow. The leakage-rate (% V/D) extrapolation ratio between the 3 kPa and 124 kPa nominal test conditions varies from 3.7 for purely turbulent flow to 30.8 for purely laminar flow. The extrapolated leakage-rate error depends heavily on the uncertainty of the " R_L " factor.

In order to quantify precisely the turbulent component of R_L and to identify its time dependent nature, a series of leakage-rate measurements at various pressure hold points were incorporated into the 1990 and 1993 reactor building pressure tests. Figure C-6 represents leakage-rate data collected at the pressure hold points during these tests. This preliminary information supports the premise that the reactor building leakage characteristic is stable over a period of many years and permits extrapolation of low-pressure test results to high-pressure leakage rates. However, the leakage rate measured during any given test will decrease over time during the test, with the rate of change decreasing with time. This phenomenon must be examined further. The low-pressure test and high-pressure test data base must be expanded to demonstrate the correlation conclusively.

The Gentilly-2 TCM system was developed with the primary goal of demonstrating "overall" containment availability. Specifically it was designed to detect a 25 mm (1") diameter leak or hole in the reactor building. However, the remarkable sensitivity of the test allows reliable detection of a 2 mm (5/64") hole. Because of the rapidity and high precision of the TCM system, it is possible to use the TCM system instead of the traditional method as the primary measurement system employed during Type A test.

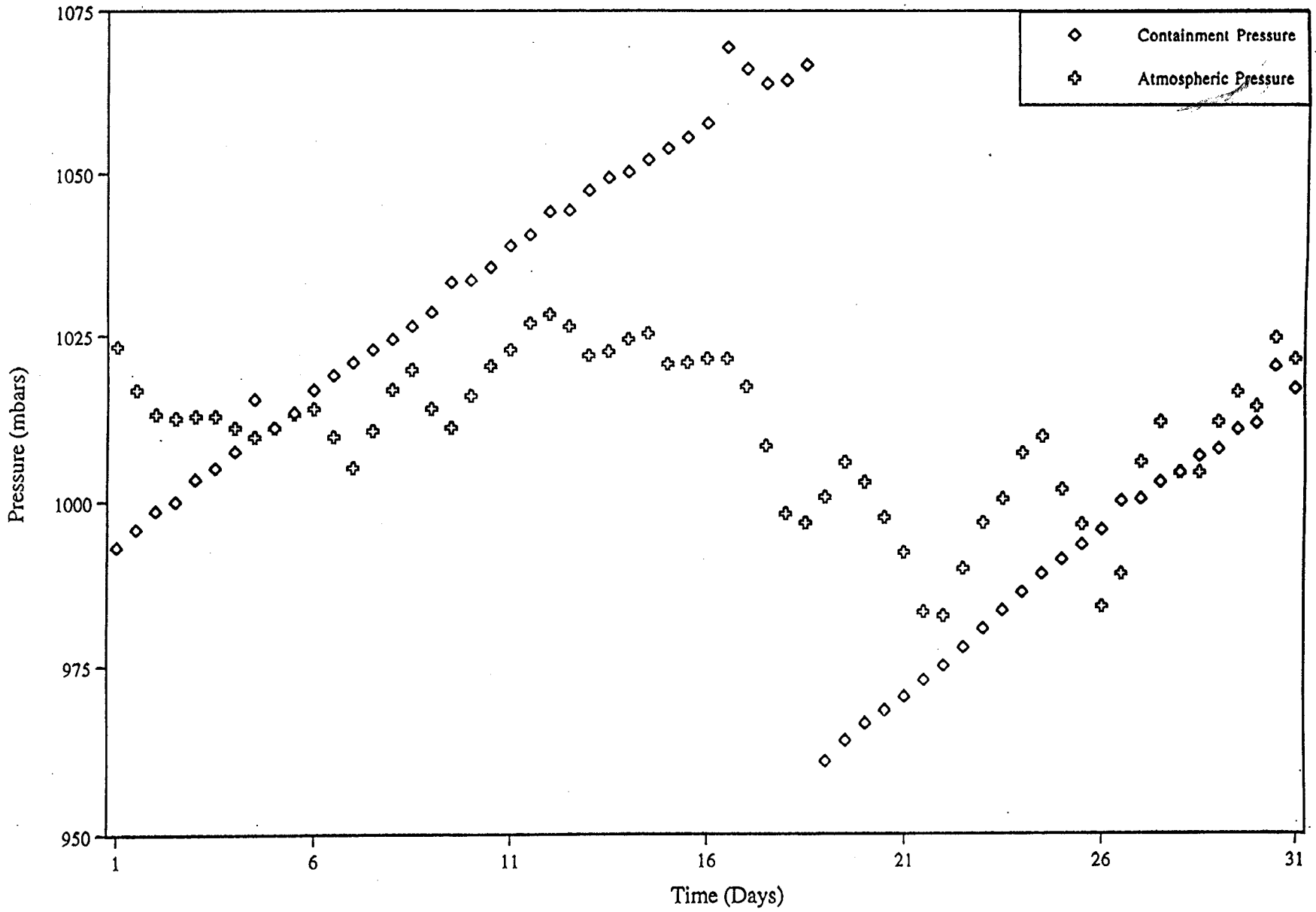

Figure C-1. Typical Containment Air Pressure Cycle

C-7

NUREG-1493

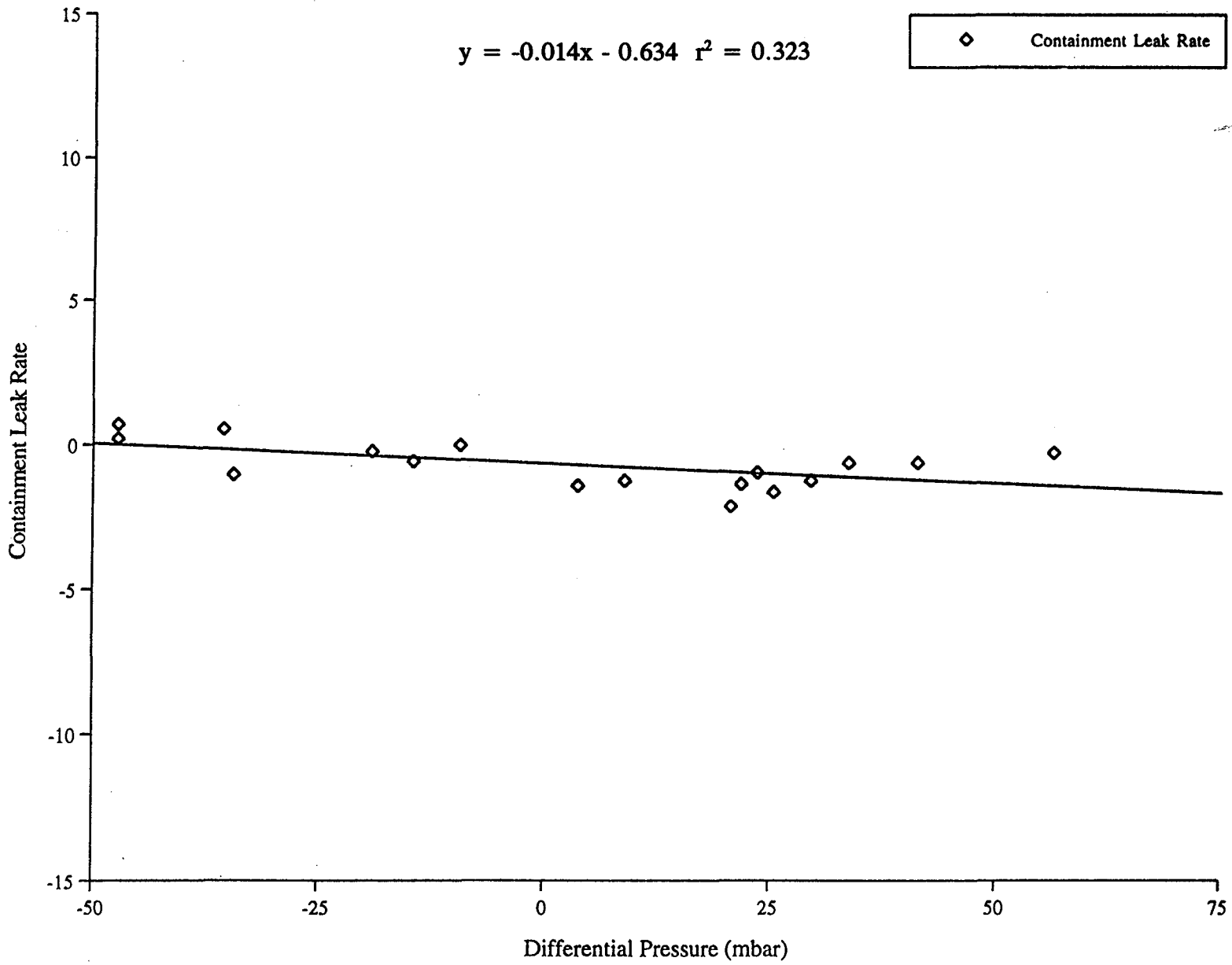

Figure C-2. Containment Leak Rate

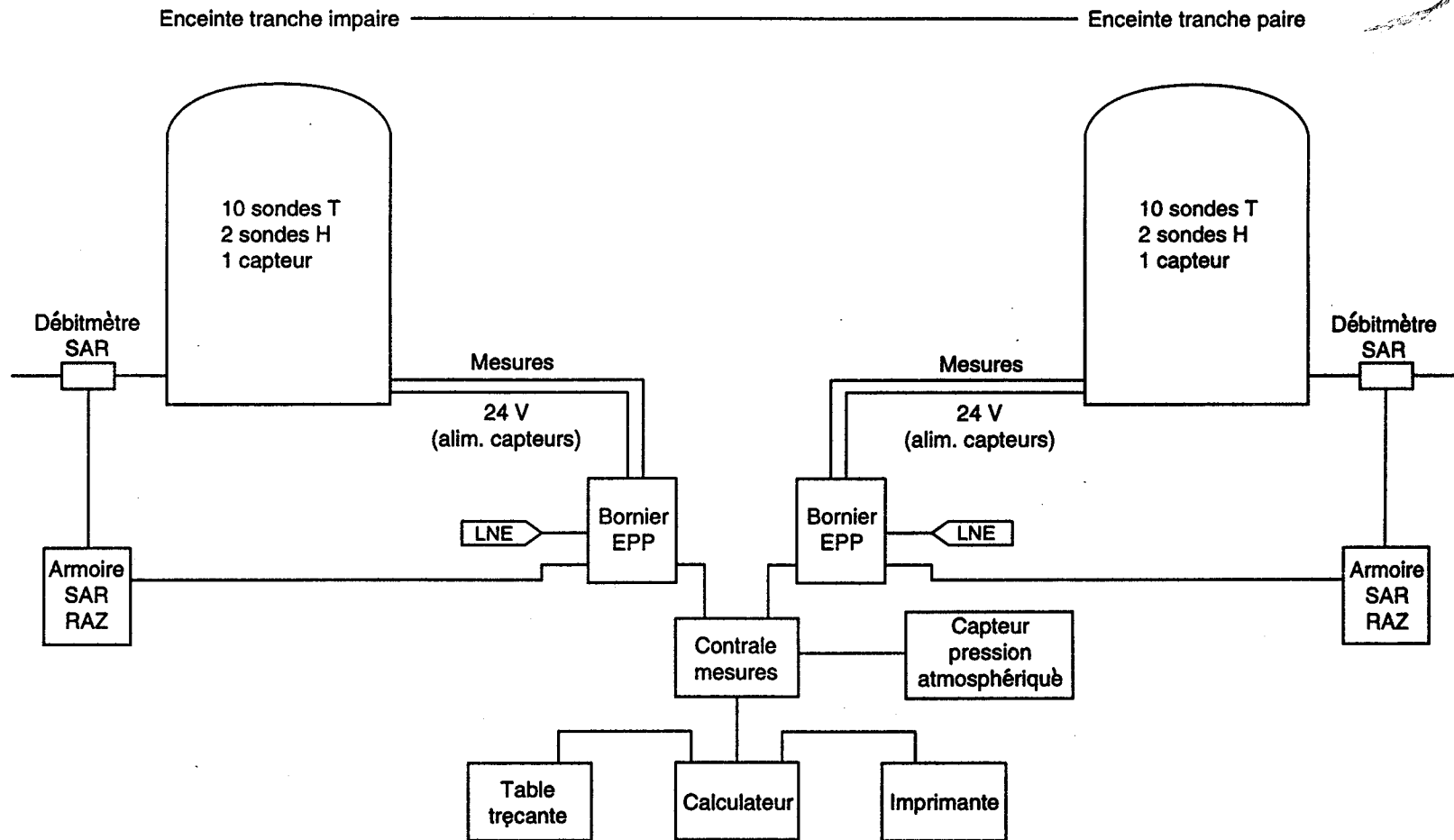
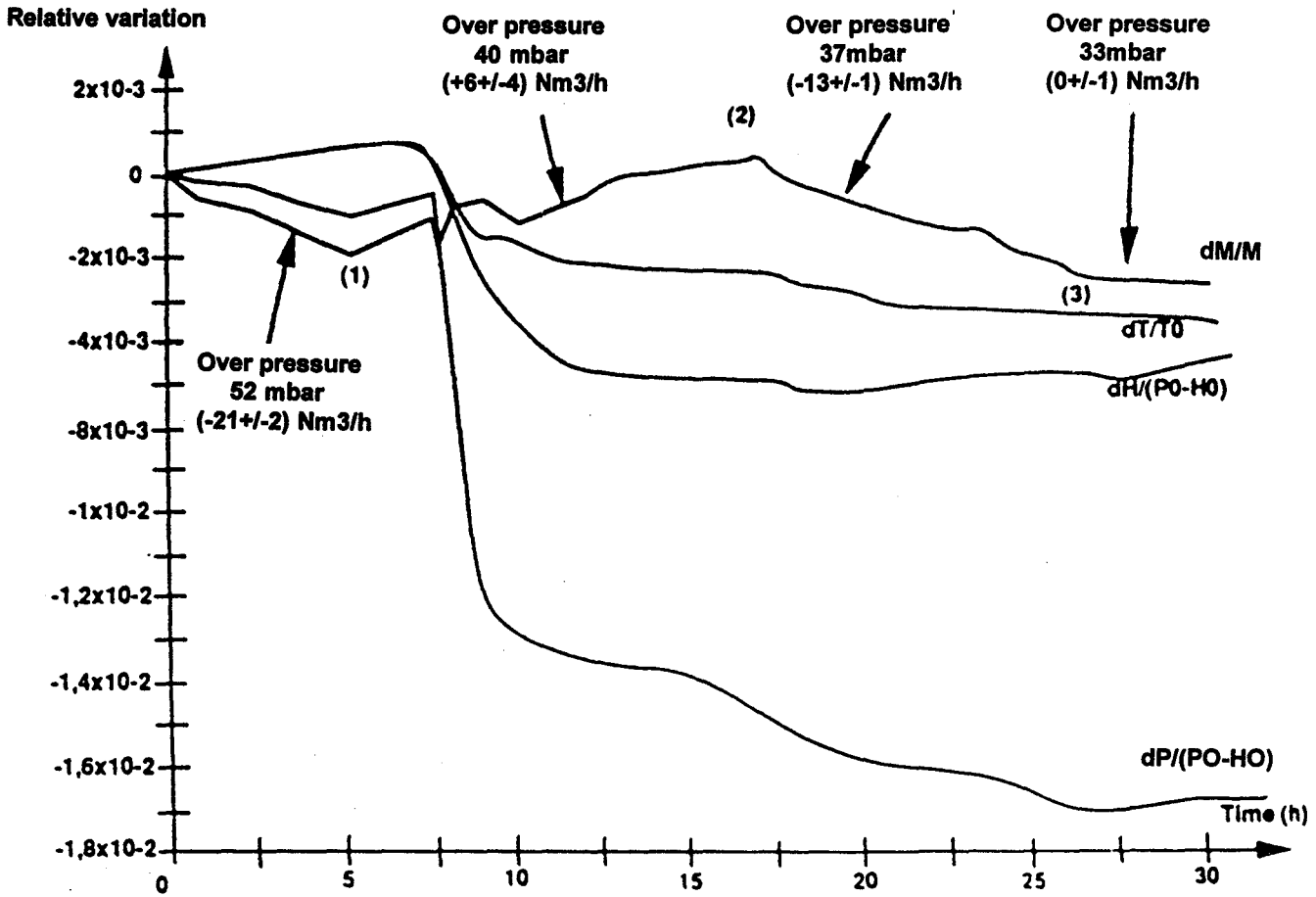

Figure C-3. Diagram of the SEXTEN System



- (1): Close the failed circuit
- (2): Open the failed circuit
- (3): Close the failed circuit and close the service compressed air distribution system.

Figure C-4. Leakage-Rate Test Results

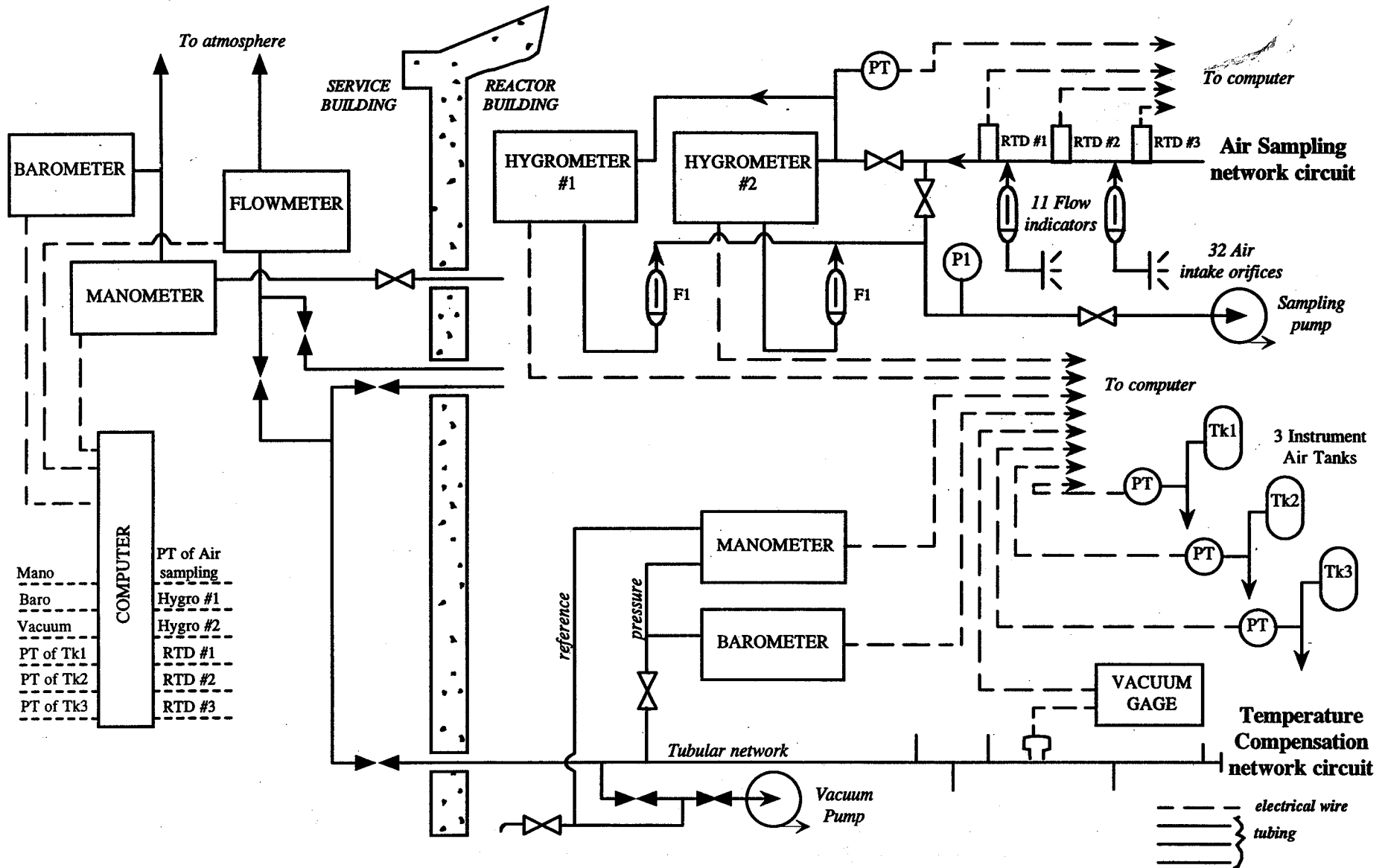

Figure C-5. Temperature Compensation Method (TCM) System

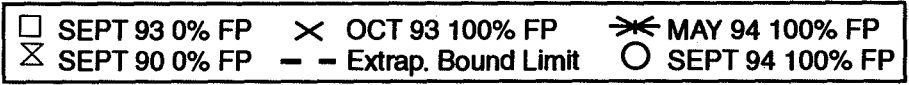
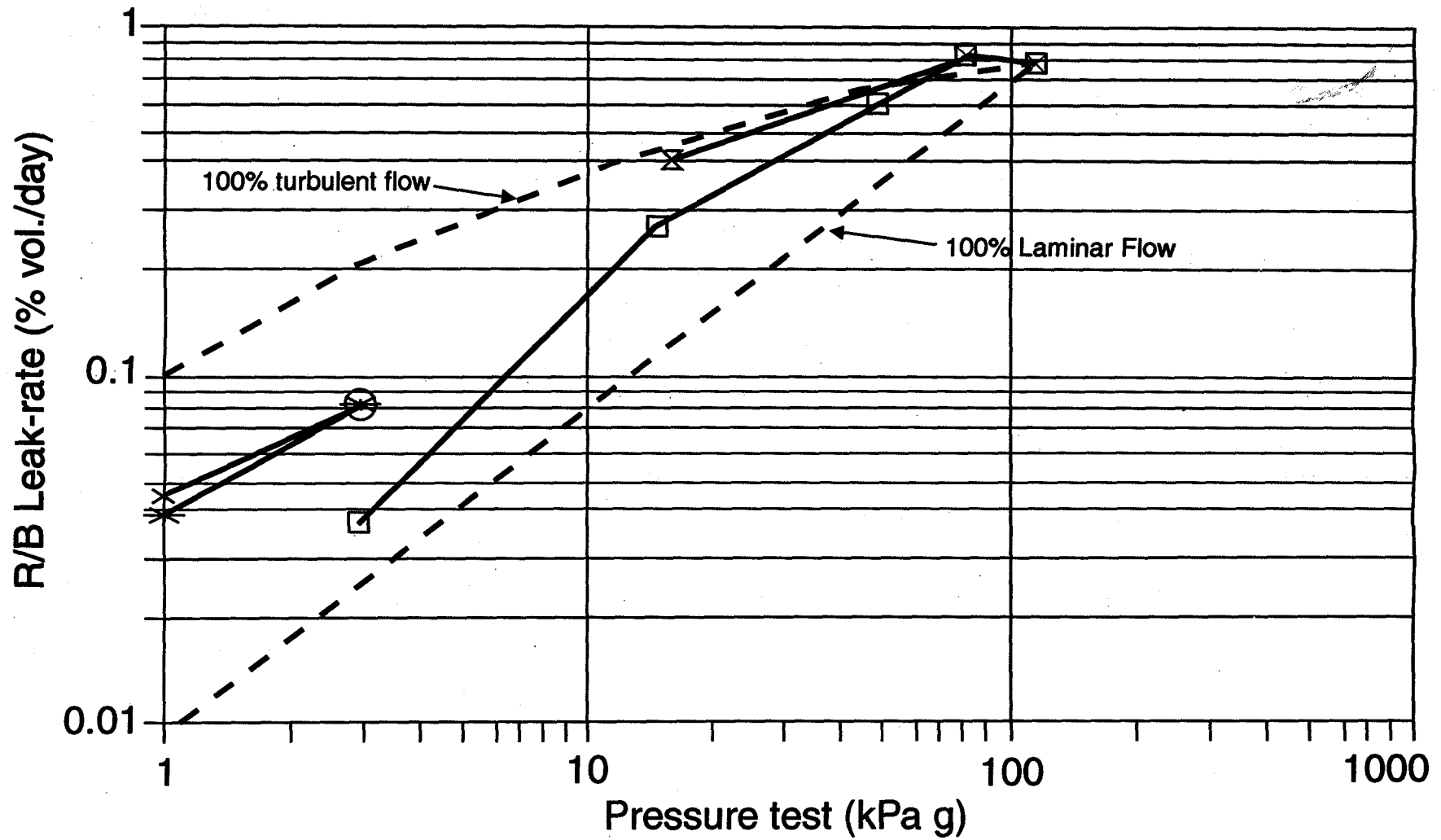
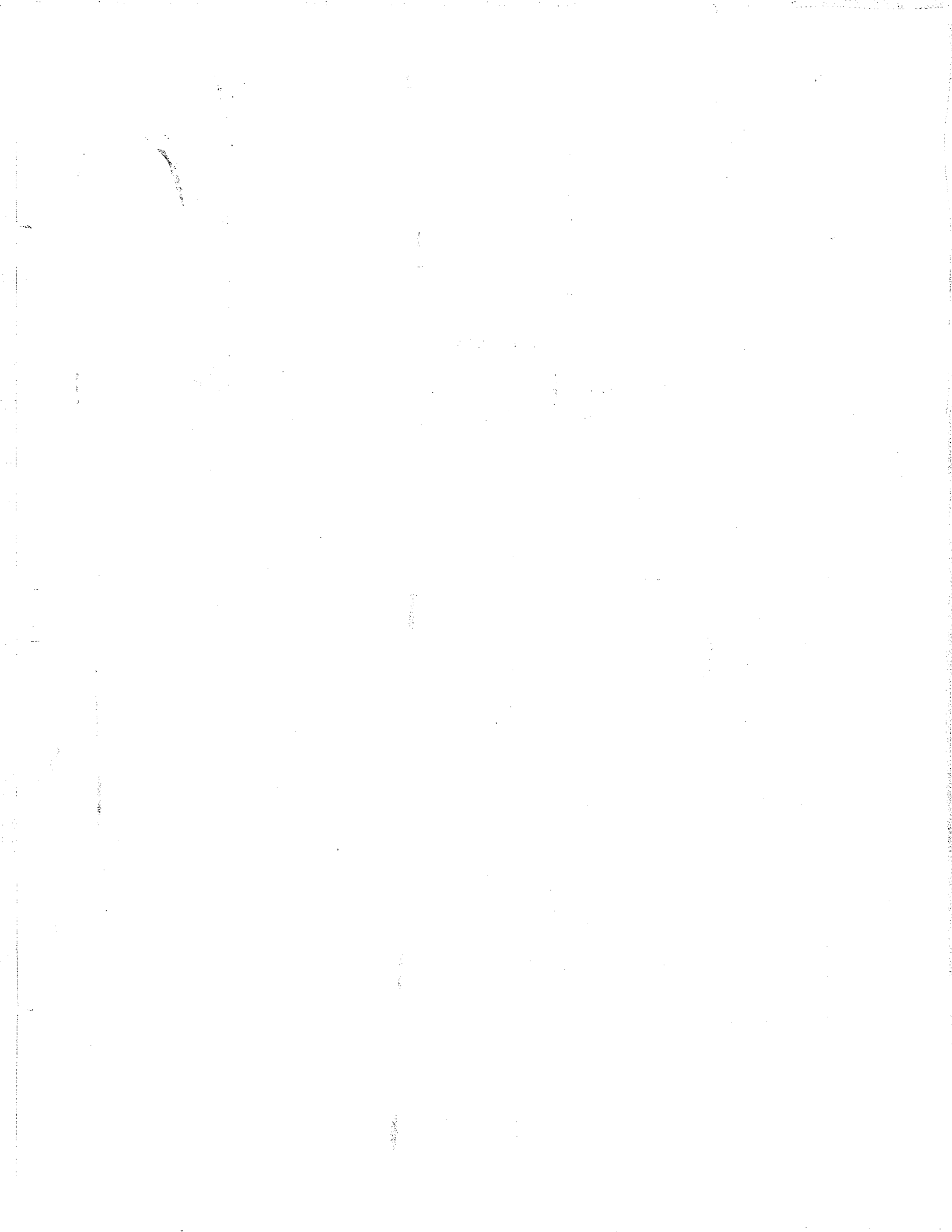
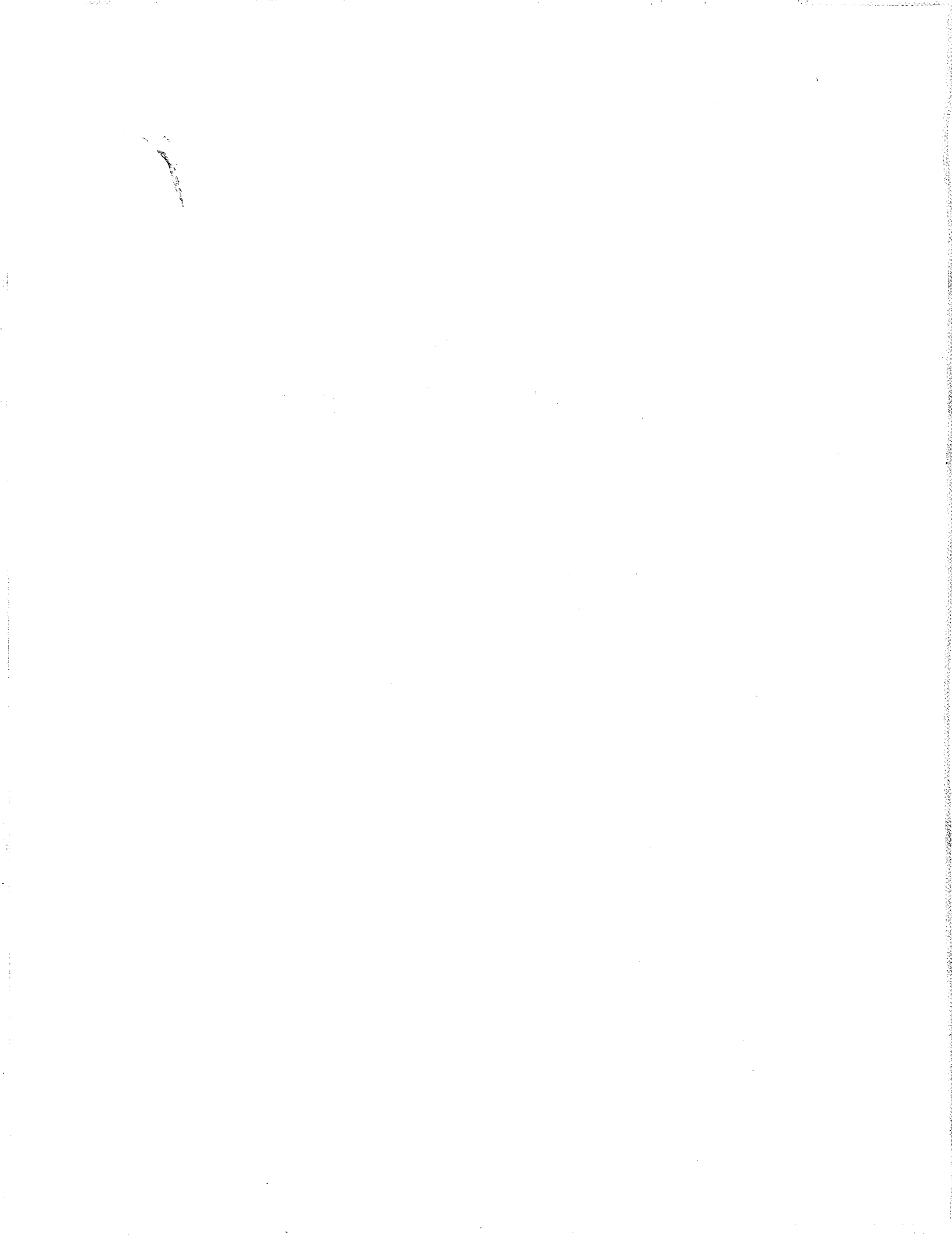

Figure C-6. Gentilly II Pressure Test For Various Pressure Hold Points



APPENDIX D

**DETAILED COST ESTIMATES FOR
20- AND 40-YEAR BASELINES AND ALTERNATIVES**



Appendix D

Baseline: 20-Year Test Cycle - No License Extensions
 Current Appendix J Requirements

Type B & C Tests (LLRTs) = \$165,000 per test
 Type A Tests (ILRTs) = \$1,890,000 per test

Period	Duration	Tests Required	Costs 5% Discount	Costs 10% Discount
13th Power Cycle	0 - 18 months			
13th Outage	18 - 20 months	B & C	153,353	143,017
14th Power Cycle	20 - 38 months			
14th Outage	38 - 40 months	A + B & C	1,619,377	1,397,561
15th Power Cycle	40 - 58 months			
15th Outage	58 - 60 months	B & C	130,331	104,087
16th Power Cycle	60 - 78 months			
16th Outage	78 - 80 months	A + B & C	1,376,264	1,017,139
17th Power Cycle	80 - 98 months			
17th Outage	98 - 100 months	B & C	110,765	75,754
18th Power Cycle	100 - 118 months			
18th Outage	118 - 120 months	A + B & C	1,169,649	740,270
19th Power Cycle	120 - 138 months			
19th Outage	138 - 140 months	B & C	94,136	55,134
20th Power Cycle	140 - 158 months			
20th Outage	158 - 160 months	A + B & C	994,053	538,765
21st Power Cycle	160 - 178 months			
21st Outage	178 - 180 months	B & C	80,003	40,126
22nd Power Cycle	180 - 198 months			
22nd Outage	198 - 200 months	A + B & C	844,818	392,111
23rd Power Cycle	200 - 218 months			
23rd Outage	218 - 220 months	B & C	67,993	29,204
24th Power Cycle Shutdown	218 - 238 months 238 - 240 months	none	0	0
Total Net Present Values			6,640,742	4,533,168

Alternative 1: 20-Year Test Cycle - No License Extensions
 Current Appendix J Test Frequencies with Higher Acceptable Leakage Rates

Type B & C Tests (LLRTs) = \$157,000 per test
 Type A Tests (ILRTs) = \$1,690,000 per test

Period	Duration	Tests Required	Costs 5% Discount	Costs 10% Discount
13th Power Cycle	0 - 18 months			
13th Outage	18 - 20 months	B & C	145,918	136,083
14th Power Cycle	20 - 38 months			
14th Outage	38 - 40 months	A + B & C	1,448,014	1,249,671
15th Power Cycle	40 - 58 months			
15th Outage	58 - 60 months	B & C	124,012	99,041
16th Power Cycle	60 - 78 months			
16th Outage	78 - 80 months	A + B & C	1,230,628	909,506
17th Power Cycle	80 - 98 months			
17th Outage	98 - 100 months	B & C	105,394	72,081
18th Power Cycle	100 - 118 months			
18th Outage	118 - 120 months	A + B & C	1,045,877	661,934
19th Power Cycle	120 - 138 months			
19th Outage	138 - 140 months	B & C	89,572	52,461
20th Power Cycle	140 - 158 months			
20th Outage	158 - 160 months	A + B & C	888,862	481,753
21st Power Cycle	160 - 178 months			
21st Outage	178 - 180 months	B & C	76,124	38,181
22nd Power Cycle	180 - 198 months			
22nd Outage	198 - 200 months	A + B & C	755,420	350,618
23rd Power Cycle	200 - 218 months			
23rd Outage	218 - 220 months	B & C	64,696	27,788
24th Power Cycle Shutdown	218 - 238 months 238 - 240 months	none	0	0
Total Net Present Values			5,974,517	4,079,117

Alternative 2: 20-Year Test Cycle - No License Extensions
 Appendix J Leakage Criteria, Frequency of ILRTs Reduced to 2/10 Years

Type B & C Tests (LLRTs) = \$165,000 per test
 Type A Tests (ILRTs) = \$1,890,000 per test

Period	Duration	Tests Required	Costs 5% Discount	Costs 10% Discount
13th Power Cycle	0 - 18 months			
13th Outage	18 - 20 months	B & C	153,353	143,017
14th Power Cycle	20 - 38 months			
14th Outage	38 - 40 months	B & C	141,374	122,009
15th Power Cycle	40 - 58 months			
15th Outage	58 - 60 months	A + B & C	1,492,880	1,192,273
16th Power Cycle	60 - 78 months			
16th Outage	78 - 80 months	B & C	120,150	88,798
17th Power Cycle	80 - 98 months			
17th Outage	98 - 100 months	B & C	110,765	75,754
18th Power Cycle	100 - 118 months			
18th Outage	118 - 120 months	A + B & C	1,169,649	740,270
19th Power Cycle	120 - 138 months			
19th Outage	138 - 140 months	B & C	94,136	55,134
20th Power Cycle	140 - 158 months			
20th Outage	158 - 160 months	B & C	86,782	47,035
21st Power Cycle	160 - 178 months			
21st Outage	178 - 180 months	A + B & C	916,403	459,626
22nd Power Cycle	180 - 198 months			
22nd Outage	198 - 200 months	B & C	73,754	34,232
23rd Power Cycle	200 - 218 months			
23rd Outage	218 - 220 months	B & C	67,993	29,204
24th Power Cycle Shutdown	218 - 238 months 238 - 240 months	none	0	0
Total Net Present Values			4,427,239	2,987,352

Alternative 3: 20-Year Test Cycle - No License Extensions
 Relaxed Leakage Criteria, Frequency of ILRTs Reduced to 2/10 Years

Type B & C Tests (LLRTs) = \$157,000 per test
 Type A Tests (ILRTs) = \$1,690,000 per test

Period	Duration	Tests Required	Costs 5% Discount	Costs 10% Discount
13th Power Cycle	0 - 18 months			
13th Outage	18 - 20 months	B & C	145,918	136,083
14th Power Cycle	20 - 38 months			
14th Outage	38 - 40 months	B & C	134,520	116,094
15th Power Cycle	40 - 58 months			
15th Outage	58 - 60 months	A + B & C	1,334,903	1,066,106
16th Power Cycle	60 - 78 months			
16th Outage	78 - 80 months	B & C	114,325	84,493
17th Power Cycle	80 - 98 months			
17th Outage	98 - 100 months	B & C	105,394	72,081
18th Power Cycle	100 - 118 months			
18th Outage	118 - 120 months	A + B & C	1,045,877	661,934
19th Power Cycle	120 - 138 months			
19th Outage	138 - 140 months	B & C	89,572	52,461
20th Power Cycle	140 - 158 months			
20th Outage	158 - 160 months	B & C	82,575	44,755
21st Power Cycle	160 - 178 months			
21st Outage	178 - 180 months	A + B & C	819,429	410,988
22nd Power Cycle	180 - 198 months			
22nd Outage	198 - 200 months	B & C	70,178	32,572
23rd Power Cycle	200 - 218 months			
23rd Outage	218 - 220 months	B & C	64,696	27,788
24th Power Cycle	218 - 238 months			
Shutdown	238 - 240 months	none	0	0
Total Net Present Values			4,007,387	2,705,355

Alternative 4: 20-Year Test Cycle - No License Extensions
 Appendix J Leakage Criteria, Frequency of ILRTs Reduced to 1/10 Years

Type B & C Tests (LLRTs) = \$165,000 per test
 Type A Tests (ILRTs) = \$1,890,000 per test

Period	Duration	Tests Required	Costs 5% Discount	Costs 10% Discount
13th Power Cycle	0 - 18 months			
13th Outage	18 - 20 months	B & C	153,353	143,017
14th Power Cycle	20 - 38 months			
14th Outage	38 - 40 months	B & C	141,374	122,009
15th Power Cycle	40 - 58 months			
15th Outage	58 - 60 months	B & C	130,331	104,087
16th Power Cycle	60 - 78 months			
16th Outage	78 - 80 months	B & C	120,150	88,798
17th Power Cycle	80 - 98 months			
17th Outage	98 - 100 months	B & C	110,765	75,754
18th Power Cycle	100 - 118 months			
18th Outage	118 - 120 months	A + B & C	1,169,649	740,270
19th Power Cycle	120 - 138 months			
19th Outage	138 - 140 months	B & C	94,136	55,134
20th Power Cycle	140 - 158 months			
20th Outage	158 - 160 months	B & C	86,782	47,035
21st Power Cycle	160 - 178 months			
21st Outage	178 - 180 months	B & C	80,003	40,126
22nd Power Cycle	180 - 198 months			
22nd Outage	198 - 200 months	B & C	73,754	34,232
23rd Power Cycle	200 - 218 months			
23rd Outage	218 - 220 months	B & C	67,993	29,204
24th Power Cycle	218 - 238 months			
Shutdown	238 - 240 months	none	0	0
Total Net Present Values			2,228,290	1,479,666

Alternative 5: 20-Year Test Cycle - No License Extensions
 Relaxed Leakage Criteria, Frequency of ILRTs Reduced to 1/10 Years

Type B & C Tests (LLRTs) = \$157,000 per test
 Type A Tests (ILRTs) = \$1,690,000 per test

Period	Duration	Tests Required	Costs 5% Discount	Costs 10% Discount
13th Power Cycle	0 - 18 months			
13th Outage	18 - 20 months	B & C	145,918	136,083
14th Power Cycle	20 - 38 months			
14th Outage	38 - 40 months	B & C	134,520	116,094
15th Power Cycle	40 - 58 months			
15th Outage	58 - 60 months	B & C	124,012	99,041
16th Power Cycle	60 - 78 months			
16th Outage	78 - 80 months	B & C	114,325	84,493
17th Power Cycle	80 - 98 months			
17th Outage	98 - 100 months	B & C	105,394	72,081
18th Power Cycle	100 - 118 months			
18th Outage	118 - 120 months	A + B & C	1,045,877	661,934
19th Power Cycle	120 - 138 months			
19th Outage	138 - 140 months	B & C	89,572	52,461
20th Power Cycle	140 - 158 months			
20th Outage	158 - 160 months	B & C	82,575	44,755
21st Power Cycle	160 - 178 months			
21st Outage	178 - 180 months	B & C	76,124	38,181
22nd Power Cycle	180 - 198 months			
22nd Outage	198 - 200 months	B & C	70,178	32,572
23rd Power Cycle	200 - 218 months			
23rd Outage	218 - 220 months	B & C	64,696	27,788
24th Power Cycle	218 - 238 months			
Shutdown	238 - 240 months	none	0	0
Total Net Present Values			2,053,191	1,365,483

Alternative 6: 20-Year Test Cycle - No License Extensions
 Appendix J Leakage Criteria, Frequency of ILRTs Reduced to 1/20 Years

Type B & C Tests (LLRTs) = \$165,000 per test
 Type A Tests (ILRTs) = \$1,890,000 per test

Period	Duration	Tests Required	Costs 5% Discount	Costs 10% Discount
13th Power Cycle	0 - 18 months			
13th Outage	18 - 20 months	B & C	153,353	143,017
14th Power Cycle	20 - 38 months			
14th Outage	38 - 40 months	B & C	141,374	122,009
15th Power Cycle	40 - 58 months			
15th Outage	58 - 60 months	B & C	130,331	104,087
16th Power Cycle	60 - 78 months			
16th Outage	78 - 80 months	B & C	120,150	88,798
17th Power Cycle	80 - 98 months			
17th Outage	98 - 100 months	B & C	110,765	75,754
18th Power Cycle	100 - 118 months			
18th Outage	118 - 120 months	B & C	102,112	64,627
19th Power Cycle	120 - 138 months			
19th Outage	138 - 140 months	B & C	94,136	55,134
20th Power Cycle	140 - 158 months			
20th Outage	158 - 160 months	B & C	86,782	47,035
21st Power Cycle	160 - 178 months			
21st Outage	178 - 180 months	B & C	80,003	40,126
22nd Power Cycle	180 - 198 months			
22nd Outage	198 - 200 months	B & C	73,754	34,232
23rd Power Cycle	200 - 218 months			
23rd Outage	218 - 220 months	B & C	67,993	29,204
24th Power Cycle	218 - 238 months			
Shutdown	238 - 240 months	none	0	0
Total Net Present Values			1,160,753	804,023

Alternative 7: 20-Year Test Cycle - No License Extensions
 Relaxed Leakage Criteria, Frequency of ILRTs Reduced to 1/20 Years

Type B & C Tests (LLRTs) = \$157,000 per test
 Type A Tests (ILRTs) = \$1,690,000 per test

Period	Duration	Tests Required	Costs 5% Discount	Costs 10% Discount
13th Power Cycle	0 - 18 months			
13th Outage	18 - 20 months	B & C	145,918	136,083
14th Power Cycle	20 - 38 months			
14th Outage	38 - 40 months	B & C	134,520	116,094
15th Power Cycle	40 - 58 months			
15th Outage	58 - 60 months	B & C	124,012	99,041
16th Power Cycle	60 - 78 months			
16th Outage	78 - 80 months	B & C	114,325	84,493
17th Power Cycle	80 - 98 months			
17th Outage	98 - 100 months	B & C	105,394	72,081
18th Power Cycle	100 - 118 months			
18th Outage	118 - 120 months	B & C	97,161	61,493
19th Power Cycle	120 - 138 months			
19th Outage	138 - 140 months	B & C	89,572	52,461
20th Power Cycle	140 - 158 months			
20th Outage	158 - 160 months	B & C	82,575	44,755
21st Power Cycle	160 - 178 months			
21st Outage	178 - 180 months	B & C	76,124	38,181
22nd Power Cycle	180 - 198 months			
22nd Outage	198 - 200 months	B & C	70,178	32,572
23rd Power Cycle	200 - 218 months			
23rd Outage	218 - 220 months	B & C	64,696	27,788
24th Power Cycle	218 - 238 months			
Shutdown	238 - 240 months	none	0	0
Total Net Present Values			1,104,475	765,042

Alternative 8: 20-Year Test Cycle - No License Extensions
 Current Leakage Criteria and ILRT Frequency, Reduced LLRTs

Type B & C Tests (LLRTs) = \$70,000 per test
 Type A Tests (ILRTs) = \$1,890,000 per test

Period	Duration	Tests Required	Costs 5% Discount	Costs 10% Discount
13th Power Cycle	0 - 18 months			
13th Outage	18 - 20 months	B & C	65,059	60,674
14th Power Cycle	20 - 38 months			
14th Outage	38 - 40 months	A + B & C	1,619,377	1,397,561
15th Power Cycle	40 - 58 months			
15th Outage	58 - 60 months	B & C	55,292	44,158
16th Power Cycle	60 - 78 months			
16th Outage	78 - 80 months	A + B & C	1,376,264	1,017,139
17th Power Cycle	80 - 98 months			
17th Outage	98 - 100 months	B & C	46,991	32,138
18th Power Cycle	100 - 118 months			
18th Outage	118 - 120 months	A + B & C	1,169,649	740,270
19th Power Cycle	120 - 138 months			
19th Outage	138 - 140 months	B & C	39,936	23,390
20th Power Cycle	140 - 158 months			
20th Outage	158 - 160 months	A + B & C	994,053	538,765
21st Power Cycle	160 - 178 months			
21st Outage	178 - 180 months	B & C	33,941	17,023
22nd Power Cycle	180 - 198 months			
22nd Outage	198 - 200 months	A + B & C	844,818	392,111
23rd Power Cycle	200 - 218 months			
23rd Outage	218 - 220 months	B & C	28,845	12,389
24th Power Cycle	218 - 238 months			
Shutdown	238 - 240 months	none	0	0
Total Net Present Values			6,274,225	4,275,618

Alternative 9: 20-Year Test Cycle - No License Extensions
 Relaxed Leakage Criteria, Reduced LLRTs

Type B & C Tests (LLRTs) = \$67,000 per test
 Type A Tests (ILRTs) = \$1,690,000 per test

Period	Duration	Tests Required	Costs 5% Discount	Costs 10% Discount
13th Power Cycle	0 - 18 months			
13th Outage	18 - 20 months	B & C	62,271	58,074
14th Power Cycle	20 - 38 months			
14th Outage	38 - 40 months	A + B & C	1,448,014	1,249,671
15th Power Cycle	40 - 58 months			
15th Outage	58 - 60 months	B & C	52,922	42,266
16th Power Cycle	60 - 78 months			
16th Outage	78 - 80 months	A + B & C	1,230,628	909,506
17th Power Cycle	80 - 98 months			
17th Outage	98 - 100 months	B & C	44,977	30,761
18th Power Cycle	100 - 118 months			
18th Outage	118 - 120 months	A + B & C	1,045,877	661,934
19th Power Cycle	120 - 138 months			
19th Outage	138 - 140 months	B & C	38,225	22,388
20th Power Cycle	140 - 158 months			
20th Outage	158 - 160 months	A + B & C	888,862	481,753
21st Power Cycle	160 - 178 months			
21st Outage	178 - 180 months	B & C	32,486	16,294
22nd Power Cycle	180 - 198 months			
22nd Outage	198 - 200 months	A + B & C	755,420	350,618
23rd Power Cycle	200 - 218 months			
23rd Outage	218 - 220 months	B & C	27,609	11,858
24th Power Cycle	218 - 238 months			
Shutdown	238 - 240 months	none	0	0
Total Net Present Values			5,627,291	3,835,123

Alternative 10: 20-Year Test Cycle - No License Extensions
 Current Leakage Criteria, 2 ILRTs/10 Years, Reduced LLRTs

Type B & C Tests (LLRTs) = \$70,000 per test
 Type A Tests (ILRTs) = \$1,890,000 per test

Period	Duration	Tests Required	Costs 5% Discount	Costs 10% Discount
13th Power Cycle	0 - 18 months			
13th Outage	18 - 20 months	B & C	65,059	60,674
14th Power Cycle	20 - 38 months			
14th Outage	38 - 40 months	B & C	59,977	51,762
15th Power Cycle	40 - 58 months			
15th Outage	58 - 60 months	A + B & C	1,492,880	1,192,273
16th Power Cycle	60 - 78 months			
16th Outage	78 - 80 months	B & C	50,973	37,672
17th Power Cycle	80 - 98 months			
17th Outage	98 - 100 months	B & C	46,991	32,138
18th Power Cycle	100 - 118 months			
18th Outage	118 - 120 months	A + B & C	1,169,649	740,270
19th Power Cycle	120 - 138 months			
19th Outage	138 - 140 months	B & C	39,936	23,390
20th Power Cycle	140 - 158 months			
20th Outage	158 - 160 months	B & C	36,817	19,954
21st Power Cycle	160 - 178 months			
21st Outage	178 - 180 months	A + B & C	916,403	459,626
22nd Power Cycle	180 - 198 months			
22nd Outage	198 - 200 months	B & C	31,290	14,523
23rd Power Cycle	200 - 218 months			
23rd Outage	218 - 220 months	B & C	28,845	12,389
24th Power Cycle	218 - 238 months			
Shutdown	238 - 240 months	none	0	0
Total Net Present Values			3,938,820	2,644,671

Alternative 11: 20-Year Test Cycle - No License Extensions
 Relaxed Leakage Criteria, 2 ILRTs/10 Years, Reduced LLRTs

Type B & C Tests (LLRTs) = \$67,000 per test
 Type A Tests (ILRTs) = \$1,690,000 per test

Period	Duration	Tests Required	Costs 5% Discount	Costs 10% Discount
13th Power Cycle	0 - 18 months			
13th Outage	18 - 20 months	B & C	62,271	58,074
14th Power Cycle	20 - 38 months			
14th Outage	38 - 40 months	B & C	57,406	49,543
15th Power Cycle	40 - 58 months			
15th Outage	58 - 60 months	A + B & C	1,334,903	1,066,106
16th Power Cycle	60 - 78 months			
16th Outage	78 - 80 months	B & C	48,788	36,057
17th Power Cycle	80 - 98 months			
17th Outage	98 - 100 months	B & C	44,977	30,761
18th Power Cycle	100 - 118 months			
18th Outage	118 - 120 months	A + B & C	1,045,877	661,934
19th Power Cycle	120 - 138 months			
19th Outage	138 - 140 months	B & C	38,225	22,388
20th Power Cycle	140 - 158 months			
20th Outage	158 - 160 months	B & C	35,239	19,099
21st Power Cycle	160 - 178 months			
21st Outage	178 - 180 months	A + B & C	819,429	410,988
22nd Power Cycle	180 - 198 months			
22nd Outage	198 - 200 months	B & C	29,949	13,900
23rd Power Cycle	200 - 218 months			
23rd Outage	218 - 220 months	B & C	27,609	11,858
24th Power Cycle	218 - 238 months			
Shutdown	238 - 240 months	none	0	0
Total Net Present Values			3,544,673	2,380,708

Alternative 12: 20-Year Test Cycle - No License Extensions
 Current Leakage Criteria, 1 ILRT/10 Years, Reduced LLRTs

Type B & C Tests (LLRTs) = \$70,000 per test
 Type A Tests (ILRTs) = \$1,890,000 per test

Period	Duration	Tests Required	Costs 5% Discount	Costs 10% Discount
13th Power Cycle	0 - 18 months			
13th Outage	18 - 20 months	B & C	65,059	60,674
14th Power Cycle	20 - 38 months			
14th Outage	38 - 40 months	B & C	59,977	51,762
15th Power Cycle	40 - 58 months			
15th Outage	58 - 60 months	B & C	55,292	44,158
16th Power Cycle	60 - 78 months			
16th Outage	78 - 80 months	B & C	50,973	37,672
17th Power Cycle	80 - 98 months			
17th Outage	98 - 100 months	B & C	46,991	32,138
18th Power Cycle	100 - 118 months			
18th Outage	118 - 120 months	A + B & C	1,169,649	740,270
19th Power Cycle	120 - 138 months			
19th Outage	138 - 140 months	B & C	39,936	23,390
20th Power Cycle	140 - 158 months			
20th Outage	158 - 160 months	B & C	36,817	19,954
21st Power Cycle	160 - 178 months			
21st Outage	178 - 180 months	B & C	33,941	17,023
22nd Power Cycle	180 - 198 months			
22nd Outage	198 - 200 months	B & C	31,290	14,523
23rd Power Cycle	200 - 218 months			
23rd Outage	218 - 220 months	B & C	28,845	12,389
24th Power Cycle	218 - 238 months			
Shutdown	238 - 240 months	none	0	0
Total Net Present Values			1,618,770	1,053,953

Alternative 13: 20-Year Test Cycle - No License Extensions
 Relaxed Leakage Criteria, 1 ILRT/10 Years, Reduced LLRTs

Type B & C Tests (LLRTs) = \$67,000 per test
 Type A Tests (ILRTs) = \$1,690,000 per test

Period	Duration	Tests Required	Costs 5% Discount	Costs 10% Discount
13th Power Cycle	0 - 18 months			
13th Outage	18 - 20 months	B & C	62,271	58,074
14th Power Cycle	20 - 38 months			
14th Outage	38 - 40 months	B & C	57,406	49,543
15th Power Cycle	40 - 58 months			
15th Outage	58 - 60 months	B & C	52,922	42,266
16th Power Cycle	60 - 78 months			
16th Outage	78 - 80 months	B & C	48,788	36,057
17th Power Cycle	80 - 98 months			
17th Outage	98 - 100 months	B & C	44,977	30,761
18th Power Cycle	100 - 118 months			
18th Outage	118 - 120 months	A + B & C	1,045,877	661,934
19th Power Cycle	120 - 138 months			
19th Outage	138 - 140 months	B & C	38,225	22,388
20th Power Cycle	140 - 158 months			
20th Outage	158 - 160 months	B & C	35,239	19,099
21st Power Cycle	160 - 178 months			
21st Outage	178 - 180 months	B & C	32,486	16,294
22nd Power Cycle	180 - 198 months			
22nd Outage	198 - 200 months	B & C	29,949	13,900
23rd Power Cycle	200 - 218 months			
23rd Outage	218 - 220 months	B & C	27,609	11,858
24th Power Cycle	218 - 238 months			
Shutdown	238 - 240 months	none	0	0
Total Net Present Values			1,475,749	962,174

Alternative 14: 20-Year Test Cycle - No License Extensions
 Current Leakage Criteria, 1 ILRT/20 Years, Reduced LLRTs

Type B & C Tests (LLRTs) = \$70,000 per test
 Type A Tests (ILRTs) = \$1,890,000 per test

Period	Duration	Tests Required	Costs 5% Discount	Costs 10% Discount
13th Power Cycle	0 - 18 months			
13th Outage	18 - 20 months	B & C	65,059	60,674
14th Power Cycle	20 - 38 months			
14th Outage	38 - 40 months	B & C	59,977	51,762
15th Power Cycle	40 - 58 months			
15th Outage	58 - 60 months	B & C	55,292	44,158
16th Power Cycle	60 - 78 months			
16th Outage	78 - 80 months	B & C	50,973	37,672
17th Power Cycle	80 - 98 months			
17th Outage	98 - 100 months	B & C	46,991	32,138
18th Power Cycle	100 - 118 months			
18th Outage	118 - 120 months	B & C	43,320	27,417
19th Power Cycle	120 - 138 months			
19th Outage	138 - 140 months	B & C	39,936	23,390
20th Power Cycle	140 - 158 months			
20th Outage	158 - 160 months	B & C	36,817	19,954
21st Power Cycle	160 - 178 months			
21st Outage	178 - 180 months	B & C	33,941	17,023
22nd Power Cycle	180 - 198 months			
22nd Outage	198 - 200 months	B & C	31,290	14,523
23rd Power Cycle	200 - 218 months			
23rd Outage	218 - 220 months	B & C	28,845	12,389
24th Power Cycle	218 - 238 months			
Shutdown	238 - 240 months	none	0	0
Total Net Present Values			492,441	341,100

Alternative 15: 20-Year Test Cycle - No License Extensions
 Relaxed Leakage Criteria, 1 ILRT/20 Years, Reduced LLRTs

Type B & C Tests (LLRTs) = \$67,000 per test
 Type A Tests (ILRTs) = \$1,690,000 per test

Period	Duration	Tests Required	Costs 5% Discount	Costs 10% Discount
13th Power Cycle	0 - 18 months			
13th Outage	18 - 20 months	B & C	62,271	58,074
14th Power Cycle	20 - 38 months			
14th Outage	38 - 40 months	B & C	57,406	49,543
15th Power Cycle	40 - 58 months			
15th Outage	58 - 60 months	B & C	52,922	42,266
16th Power Cycle	60 - 78 months			
16th Outage	78 - 80 months	B & C	48,788	36,057
17th Power Cycle	80 - 98 months			
17th Outage	98 - 100 months	B & C	44,977	30,761
18th Power Cycle	100 - 118 months			
18th Outage	118 - 120 months	B & C	41,464	26,242
19th Power Cycle	120 - 138 months			
19th Outage	138 - 140 months	B & C	38,225	22,388
20th Power Cycle	140 - 158 months			
20th Outage	158 - 160 months	B & C	35,239	19,099
21st Power Cycle	160 - 178 months			
21st Outage	178 - 180 months	B & C	32,486	16,294
22nd Power Cycle	180 - 198 months			
22nd Outage	198 - 200 months	B & C	29,949	13,900
23rd Power Cycle	200 - 218 months			
23rd Outage	218 - 220 months	B & C	27,609	11,858
24th Power Cycle Shutdown	218 - 238 months 238 - 240 months	none	0	0
Total Net Present Values			471,336	326,482

Baseline: 40-Year Test Cycle - 20-Year License Extensions
 Current Appendix J Requirements

Type B & C Tests (LLRTs) = \$165,000 per test
 Type A Tests (ILRTs) = \$1,890,000 per test

Period	Duration	Tests Required	Costs 5% Discount	Costs 10% Discount
13th Power Cycle	0 - 18 months			
13th Outage	18 - 20 months	B & C	153,353	143,017
14th Power Cycle	20 - 38 months			
14th Outage	38 - 40 months	A + B & C	1,619,377	1,397,561
15th Power Cycle	40 - 58 months			
15th Outage	58 - 60 months	B & C	130,331	104,087
16th Power Cycle	60 - 78 months			
16th Outage	78 - 80 months	A + B & C	1,376,264	1,017,139
17th Power Cycle	80 - 98 months			
17th Outage	98 - 100 months	B & C	110,765	75,754
18th Power Cycle	100 - 118 months			
18th Outage	118 - 120 months	A + B & C	1,169,649	740,270
19th Power Cycle	120 - 138 months			
19th Outage	138 - 140 months	B & C	94,136	55,134
20th Power Cycle	140 - 158 months			
20th Outage	158 - 160 months	A + B & C	994,053	538,765
21st Power Cycle	160 - 178 months			
21st Outage	178 - 180 months	B & C	80,003	40,126
22nd Power Cycle	180 - 198 months			
22nd Outage	198 - 200 months	A + B & C	844,818	392,111
23rd Power Cycle	200 - 218 months			
23rd Outage	218 - 220 months	B & C	67,993	29,204
24th Power Cycle	218 - 238 months			
24th Outage	238 - 240 months	A + B & C	717,988	285,377
25th Power Cycle	240 - 258 months			
25th Outage	258 - 260 months	B & C	57,785	21,254
26th Power Cycle	260 - 278 months			
26th Outage	278 - 280 months	A + B & C	610,198	207,696
27th Power Cycle	280 - 298 months			
27th Outage	298 - 300 months	B & C	49,110	15,469
28th Power Cycle	300 - 318 months			
28th Outage	318 - 320 months	A + B & C	518,591	151,160
29th Power Cycle	320 - 338 months			
29th Outage	338 - 340 months	B & C	41,737	11,258
30th Power Cycle	340 - 358 months			
30th Outage	358 - 360 months	A + B & C	440,736	110,014
31st Power Cycle	360 - 378 months			
31st Outage	378 - 380 months	B & C	35,471	8,194
32nd Power Cycle	380 - 398 months			
32nd Outage	398 - 400 months	A + B & C	374,570	80,068
33rd Power Cycle	400 - 418 months			
33rd Outage	418 - 420 months	B & C	30,146	5,963
34th Power Cycle	420 - 438 months			
34th Outage	438 - 440 months	A + B & C	318,336	58,273
35th Power Cycle	440 - 458 months			
35th Outage	458 - 460 months	B & C	25,620	4,340
36th Power Cycle Shutdown	460 - 480 months	none	0	0
Total Net Present Values			9,861,030	5,492,234

Alternative 1: 40-Year Test Cycle - 20-Year License Extensions
 Current Appendix J Test Frequencies with Higher Acceptable Leakage Rates

Type B & C Tests (LLRTs) = \$157,000 per test
 Type A Tests (ILRTs) = \$1,690,000 per test

Period	Duration	Tests Required	Costs 5% Discount	Costs 10% Discount
13th Power Cycle	0 - 18 months			
13th Outage	18 - 20 months	B & C	145,918	136,083
14th Power Cycle	20 - 38 months			
14th Outage	38 - 40 months	A + B & C	1,448,014	1,249,671
15th Power Cycle	40 - 58 months			
15th Outage	58 - 60 months	B & C	124,012	99,041
16th Power Cycle	60 - 78 months			
16th Outage	78 - 80 months	A + B & C	1,230,628	909,506
17th Power Cycle	80 - 98 months			
17th Outage	98 - 100 months	B & C	105,394	72,081
18th Power Cycle	100 - 118 months			
18th Outage	118 - 120 months	A + B & C	1,045,877	661,934
19th Power Cycle	120 - 138 months			
19th Outage	138 - 140 months	B & C	89,572	52,461
20th Power Cycle	140 - 158 months			
20th Outage	158 - 160 months	A + B & C	888,862	481,753
21st Power Cycle	160 - 178 months			
21st Outage	178 - 180 months	B & C	76,124	38,181
22nd Power Cycle	180 - 198 months			
22nd Outage	198 - 200 months	A + B & C	755,420	350,618
23rd Power Cycle	200 - 218 months			
23rd Outage	218 - 220 months	B & C	64,696	27,788
24th Power Cycle	218 - 238 months			
24th Outage	238 - 240 months	A + B & C	642,010	255,178
25th Power Cycle	240 - 258 months			
25th Outage	258 - 260 months	B & C	54,983	20,224
26th Power Cycle	260 - 278 months			
26th Outage	278 - 280 months	A + B & C	545,627	185,718
27th Power Cycle	280 - 298 months			
27th Outage	298 - 300 months	B & C	46,729	14,719
28th Power Cycle	300 - 318 months			
28th Outage	318 - 320 months	A + B & C	463,714	135,165
29th Power Cycle	320 - 338 months			
29th Outage	338 - 340 months	B & C	39,714	10,712
30th Power Cycle	340 - 358 months			
30th Outage	358 - 360 months	A + B & C	394,097	98,372
31st Power Cycle	360 - 378 months			
31st Outage	378 - 380 months	B & C	33,752	7,796
32nd Power Cycle	380 - 398 months			
32nd Outage	398 - 400 months	A + B & C	334,933	71,595
33rd Power Cycle	400 - 418 months			
33rd Outage	418 - 420 months	B & C	28,685	5,674
34th Power Cycle	420 - 438 months			
34th Outage	438 - 440 months	A + B & C	284,650	52,106
35th Power Cycle	440 - 458 months			
35th Outage	458 - 460 months	B & C	24,378	4,130
36th Power Cycle	460 - 478 months			
Shutdown	478 - 480 months	none	0	0
Total Net Present Values			8,867,789	4,940,506

Alternative 2: 40-Year Test Cycle - 20-Year License Extensions
 Appendix J Leakage Criteria, Frequency of ILRTs Reduced to 2/10 Years

Type B & C Tests (LLRTs) = \$165,000 per test
 Type A Tests (ILRTs) = \$1,890,000 per test

Period	Duration	Tests Required	Costs 5% Discount	Costs 10% Discount
13th Power Cycle	0 - 18 months			
13th Outage	18 - 20 months	B & C	153,353	143,017
14th Power Cycle	20 - 38 months			
14th Outage	38 - 40 months	B & C	141,374	122,009
15th Power Cycle	40 - 58 months			
15th Outage	58 - 60 months	A + B & C	1,492,880	1,192,273
16th Power Cycle	60 - 78 months			
16th Outage	78 - 80 months	B & C	120,150	88,798
17th Power Cycle	80 - 98 months			
17th Outage	98 - 100 months	B & C	110,765	75,754
18th Power Cycle	100 - 118 months			
18th Outage	118 - 120 months	A + B & C	1,169,649	740,270
19th Power Cycle	120 - 138 months			
19th Outage	138 - 140 months	B & C	94,136	55,134
20th Power Cycle	140 - 158 months			
20th Outage	158 - 160 months	B & C	86,782	47,035
21st Power Cycle	160 - 178 months			
21st Outage	178 - 180 months	A + B & C	916,403	459,626
22nd Power Cycle	180 - 198 months			
22nd Outage	198 - 200 months	B & C	73,754	34,232
23rd Power Cycle	200 - 218 months			
23rd Outage	218 - 220 months	B & C	67,993	29,204
24th Power Cycle	218 - 238 months			
24th Outage	238 - 240 months	A + B & C	717,988	285,377
25th Power Cycle	240 - 258 months			
25th Outage	258 - 260 months	B & C	57,785	21,254
26th Power Cycle	260 - 278 months			
26th Outage	278 - 280 months	B & C	53,271	18,132
27th Power Cycle	280 - 298 months			
27th Outage	298 - 300 months	A + B & C	562,533	177,188
28th Power Cycle	300 - 318 months			
28th Outage	318 - 320 months	B & C	45,274	13,197
29th Power Cycle	320 - 338 months			
29th Outage	338 - 340 months	B & C	41,737	11,258
30th Power Cycle	340 - 358 months			
30th Outage	358 - 360 months	A + B & C	440,736	110,014
31st Power Cycle	360 - 378 months			
31st Outage	378 - 380 months	B & C	35,471	8,194
32nd Power Cycle	380 - 398 months			
32nd Outage	398 - 400 months	B & C	32,701	6,990
33rd Power Cycle	400 - 418 months			
33rd Outage	418 - 420 months	A + B & C	345,310	68,306
34th Power Cycle	420 - 438 months			
34th Outage	438 - 440 months	B & C	27,791	5,087
35th Power Cycle	440 - 458 months			
35th Outage	458 - 460 months	B & C	25,620	4,340
36th Power Cycle	460 - 478 months			
Shutdown	478 - 480 months	none	0	0
Total Net Present Values			6,813,456	3,716,689

Alternative 3: 40-Year Test Cycle - 20-Year License Extensions
 Relaxed Leakage Criteria, Frequency of ILRTs Reduced to 2/10 Years

Type B & C Tests (LLRTs) = \$157,000 per test
 Type A Tests (ILRTs) = \$1,690,000 per test

Period	Duration	Tests Required	Costs 5% Discount	Costs 10% Discount
13th Power Cycle	0 - 18 months			
13th Outage	18 - 20 months	B & C	145,918	136,083
14th Power Cycle	20 - 38 months			
14th Outage	38 - 40 months	B & C	134,520	116,094
15th Power Cycle	40 - 58 months			
15th Outage	58 - 60 months	A + B & C	1,334,903	1,066,106
16th Power Cycle	60 - 78 months			
16th Outage	78 - 80 months	B & C	114,325	84,493
17th Power Cycle	80 - 98 months			
17th Outage	98 - 100 months	B & C	105,394	72,081
18th Power Cycle	100 - 118 months			
18th Outage	118 - 120 months	A + B & C	1,045,877	661,934
19th Power Cycle	120 - 138 months			
19th Outage	138 - 140 months	B & C	89,572	52,461
20th Power Cycle	140 - 158 months			
20th Outage	158 - 160 months	B & C	82,575	44,755
21st Power Cycle	160 - 178 months			
21st Outage	178 - 180 months	A + B & C	819,429	410,988
22nd Power Cycle	180 - 198 months			
22nd Outage	198 - 200 months	B & C	70,178	32,572
23rd Power Cycle	200 - 218 months			
23rd Outage	218 - 220 months	B & C	64,696	27,788
24th Power Cycle	218 - 238 months			
24th Outage	238 - 240 months	A + B & C	642,010	255,178
25th Power Cycle	240 - 258 months			
25th Outage	258 - 260 months	B & C	54,983	20,224
26th Power Cycle	260 - 278 months			
26th Outage	278 - 280 months	B & C	50,688	17,253
27th Power Cycle	280 - 298 months			
27th Outage	298 - 300 months	A + B & C	503,006	158,438
28th Power Cycle	300 - 318 months			
28th Outage	318 - 320 months	B & C	43,079	12,557
29th Power Cycle	320 - 338 months			
29th Outage	338 - 340 months	B & C	39,714	10,712
30th Power Cycle	340 - 358 months			
30th Outage	358 - 360 months	A + B & C	394,097	98,372
31st Power Cycle	360 - 378 months			
31st Outage	378 - 380 months	B & C	33,752	7,796
32nd Power Cycle	380 - 398 months			
32nd Outage	398 - 400 months	B & C	31,115	6,651
33rd Power Cycle	400 - 418 months			
33rd Outage	418 - 420 months	A + B & C	308,769	61,078
34th Power Cycle	420 - 438 months			
34th Outage	438 - 440 months	B & C	26,444	4,841
35th Power Cycle	440 - 458 months			
35th Outage	458 - 460 months	B & C	24,378	4,130
36th Power Cycle	460 - 478 months			
Shutdown	478 - 480 months	none	0	0
Total Net Present Values			6,159,422	3,362,585

Alternative 4: 40-Year Test Cycle - 20-Year License Extensions
 Appendix J Leakage Criteria, Frequency of ILRTs Reduced to 1/10 Years

Type B & C Tests (LLRTs) = \$165,000 per test
 Type A Tests (ILRTs) = \$1,890,000 per test

Period	Duration	Tests Required	Costs 5% Discount	Costs 10% Discount
13th Power Cycle	0 - 18 months			
13th Outage	18 - 20 months	B & C	153,353	143,017
14th Power Cycle	20 - 38 months			
14th Outage	38 - 40 months	B & C	141,374	122,009
15th Power Cycle	40 - 58 months			
15th Outage	58 - 60 months	B & C	130,331	104,087
16th Power Cycle	60 - 78 months			
16th Outage	78 - 80 months	B & C	120,150	88,798
17th Power Cycle	80 - 98 months			
17th Outage	98 - 100 months	B & C	110,765	75,754
18th Power Cycle	100 - 118 months			
18th Outage	118 - 120 months	A + B & C	1,169,649	740,270
19th Power Cycle	120 - 138 months			
19th Outage	138 - 140 months	B & C	94,136	55,134
20th Power Cycle	140 - 158 months			
20th Outage	158 - 160 months	B & C	86,782	47,035
21st Power Cycle	160 - 178 months			
21st Outage	178 - 180 months	B & C	80,003	40,126
22nd Power Cycle	180 - 198 months			
22nd Outage	198 - 200 months	B & C	73,754	34,232
23rd Power Cycle	200 - 218 months			
23rd Outage	218 - 220 months	B & C	67,993	29,204
24th Power Cycle	218 - 238 months			
24th Outage	238 - 240 months	A + B & C	717,988	285,377
25th Power Cycle	240 - 258 months			
25th Outage	258 - 260 months	B & C	57,785	21,254
26th Power Cycle	260 - 278 months			
26th Outage	278 - 280 months	B & C	53,271	18,132
27th Power Cycle	280 - 298 months			
27th Outage	298 - 300 months	B & C	49,110	15,469
28th Power Cycle	300 - 318 months			
28th Outage	318 - 320 months	B & C	45,274	13,197
29th Power Cycle	320 - 338 months			
29th Outage	338 - 340 months	B & C	41,737	11,258
30th Power Cycle	340 - 358 months			
30th Outage	358 - 360 months	A + B & C	440,736	110,014
31st Power Cycle	360 - 378 months			
31st Outage	378 - 380 months	B & C	35,471	8,194
32nd Power Cycle	380 - 398 months			
32nd Outage	398 - 400 months	B & C	32,701	6,990
33rd Power Cycle	400 - 418 months			
33rd Outage	418 - 420 months	B & C	30,146	5,963
34th Power Cycle	420 - 438 months			
34th Outage	438 - 440 months	B & C	27,791	5,087
35th Power Cycle	440 - 458 months			
35th Outage	458 - 460 months	B & C	25,620	4,340
36th Power Cycle	460 - 478 months			
Shutdown	478 - 480 months	none	0	0
Total Net Present Values			3,785,920	1,984,941

Alternative 5: 40-Year Test Cycle - 20-Year License Extensions
 Relaxed Leakage Criteria, Frequency of ILRTs Reduced to 1/10 Years

Type B & C Tests (LLRTs) = \$157,000 per test
 Type A Tests (ILRTs) = \$1,690,000 per test

Period	Duration	Tests Required	Costs 5% Discount	Costs 10% Discount
13th Power Cycle	0 - 18 months			
13th Outage	18 - 20 months	B & C	145,918	136,083
14th Power Cycle	20 - 38 months			
14th Outage	38 - 40 months	B & C	134,520	116,094
15th Power Cycle	40 - 58 months			
15th Outage	58 - 60 months	B & C	124,012	99,041
16th Power Cycle	60 - 78 months			
16th Outage	78 - 80 months	B & C	114,325	84,493
17th Power Cycle	80 - 98 months			
17th Outage	98 - 100 months	B & C	105,394	72,081
18th Power Cycle	100 - 118 months			
18th Outage	118 - 120 months	A + B & C	1,045,877	661,934
19th Power Cycle	120 - 138 months			
19th Outage	138 - 140 months	B & C	89,572	52,461
20th Power Cycle	140 - 158 months			
20th Outage	158 - 160 months	B & C	82,575	44,755
21st Power Cycle	160 - 178 months			
21st Outage	178 - 180 months	B & C	76,124	38,181
22nd Power Cycle	180 - 198 months			
22nd Outage	198 - 200 months	B & C	70,178	32,572
23rd Power Cycle	200 - 218 months			
23rd Outage	218 - 220 months	B & C	64,696	27,788
24th Power Cycle	218 - 238 months			
24th Outage	238 - 240 months	A + B & C	642,010	255,178
25th Power Cycle	240 - 258 months			
25th Outage	258 - 260 months	B & C	54,983	20,224
26th Power Cycle	260 - 278 months			
26th Outage	278 - 280 months	B & C	50,688	17,253
27th Power Cycle	280 - 298 months			
27th Outage	298 - 300 months	B & C	46,729	14,719
28th Power Cycle	300 - 318 months			
28th Outage	318 - 320 months	B & C	43,079	12,557
29th Power Cycle	320 - 338 months			
29th Outage	338 - 340 months	B & C	39,714	10,712
30th Power Cycle	340 - 358 months			
30th Outage	358 - 360 months	A + B & C	394,097	98,372
31st Power Cycle	360 - 378 months			
31st Outage	378 - 380 months	B & C	33,752	7,796
32nd Power Cycle	380 - 398 months			
32nd Outage	398 - 400 months	B & C	31,115	6,651
33rd Power Cycle	400 - 418 months			
33rd Outage	418 - 420 months	B & C	28,685	5,674
34th Power Cycle	420 - 438 months			
34th Outage	438 - 440 months	B & C	26,444	4,841
35th Power Cycle	440 - 458 months			
35th Outage	458 - 460 months	B & C	24,378	4,130
36th Power Cycle	460 - 478 months			
Shutdown	478 - 480 months	none	0	0
Total Net Present Values			3,468,865	1,823,590

Alternative 6: 40-Year Test Cycle - 20-Year License Extensions
 Appendix J Leakage Criteria, Frequency of ILRTs Reduced to 1/20 Years

Type B & C Tests (LLRTs) = \$165,000 per test
 Type A Tests (ILRTs) = \$1,890,000 per test

Period	Duration	Tests Required	Costs 5% Discount	Costs 10% Discount
13th Power Cycle	0 - 18 months			
13th Outage	18 - 20 months	B & C	153,353	143,017
14th Power Cycle	20 - 38 months			
14th Outage	38 - 40 months	B & C	141,374	122,009
15th Power Cycle	40 - 58 months			
15th Outage	58 - 60 months	B & C	130,331	104,087
16th Power Cycle	60 - 78 months			
16th Outage	78 - 80 months	B & C	120,150	88,798
17th Power Cycle	80 - 98 months			
17th Outage	98 - 100 months	B & C	110,765	75,754
18th Power Cycle	100 - 118 months			
18th Outage	118 - 120 months	B & C	102,112	64,627
19th Power Cycle	120 - 138 months			
19th Outage	138 - 140 months	B & C	94,136	55,134
20th Power Cycle	140 - 158 months			
20th Outage	158 - 160 months	B & C	86,782	47,035
21st Power Cycle	160 - 178 months			
21st Outage	178 - 180 months	B & C	80,003	40,126
22nd Power Cycle	180 - 198 months			
22nd Outage	198 - 200 months	B & C	73,754	34,232
23rd Power Cycle	200 - 218 months			
23rd Outage	218 - 220 months	B & C	67,993	29,204
24th Power Cycle	218 - 238 months			
24th Outage	238 - 240 months	A + B & C	717,988	285,377
25th Power Cycle	240 - 258 months			
25th Outage	258 - 260 months	B & C	57,785	21,254
26th Power Cycle	260 - 278 months			
26th Outage	278 - 280 months	B & C	53,271	18,132
27th Power Cycle	280 - 298 months			
27th Outage	298 - 300 months	B & C	49,110	15,469
28th Power Cycle	300 - 318 months			
28th Outage	318 - 320 months	B & C	45,274	13,197
29th Power Cycle	320 - 338 months			
29th Outage	338 - 340 months	B & C	41,737	11,258
30th Power Cycle	340 - 358 months			
30th Outage	358 - 360 months	B & C	38,477	9,604
31st Power Cycle	360 - 378 months			
31st Outage	378 - 380 months	B & C	35,471	8,194
32nd Power Cycle	380 - 398 months			
32nd Outage	398 - 400 months	B & C	32,701	6,990
33rd Power Cycle	400 - 418 months			
33rd Outage	418 - 420 months	B & C	30,146	5,963
34th Power Cycle	420 - 438 months			
34th Outage	438 - 440 months	B & C	27,791	5,087
35th Power Cycle	440 - 458 months			
35th Outage	458 - 460 months	B & C	25,620	4,340
36th Power Cycle Shutdown	460 - 478 months			
Shutdown	478 - 480 months	none	0	0
Total Net Present Values			2,316,124	1,208,888

Alternative 7; 40-Year Test Cycle - 20-Year License Extensions
 Relaxed Leakage Criteria, Frequency of ILRTs Reduced to 1/20 Years

Type B & C Tests (LLRTs) = \$157,000 per test
 Type A Tests (ILRTs) = \$1,690,000 per test

Period	Duration	Tests Required	Costs 5% Discount	Costs 10% Discount
13th Power Cycle	0 - 18 months			
13th Outage	18 - 20 months	B & C	145,918	136,083
14th Power Cycle	20 - 38 months			
14th Outage	38 - 40 months	B & C	134,520	116,094
15th Power Cycle	40 - 58 months			
15th Outage	58 - 60 months	B & C	124,012	99,041
16th Power Cycle	60 - 78 months			
16th Outage	78 - 80 months	B & C	114,325	84,493
17th Power Cycle	80 - 98 months			
17th Outage	98 - 100 months	B & C	105,394	72,081
18th Power Cycle	100 - 118 months			
18th Outage	118 - 120 months	B & C	97,161	61,493
19th Power Cycle	120 - 138 months			
19th Outage	138 - 140 months	B & C	89,572	52,461
20th Power Cycle	140 - 158 months			
20th Outage	158 - 160 months	B & C	82,575	44,755
21st Power Cycle	160 - 178 months			
21st Outage	178 - 180 months	B & C	76,124	38,181
22nd Power Cycle	180 - 198 months			
22nd Outage	198 - 200 months	B & C	70,178	32,572
23rd Power Cycle	200 - 218 months			
23rd Outage	218 - 220 months	B & C	64,696	27,788
24th Power Cycle	218 - 238 months			
24th Outage	238 - 240 months	A + B & C	642,010	255,178
25th Power Cycle	240 - 258 months			
25th Outage	258 - 260 months	B & C	54,983	20,224
26th Power Cycle	260 - 278 months			
26th Outage	278 - 280 months	B & C	50,688	17,253
27th Power Cycle	280 - 298 months			
27th Outage	298 - 300 months	B & C	46,729	14,719
28th Power Cycle	300 - 318 months			
28th Outage	318 - 320 months	B & C	43,079	12,557
29th Power Cycle	320 - 338 months			
29th Outage	338 - 340 months	B & C	39,714	10,712
30th Power Cycle	340 - 358 months			
30th Outage	358 - 360 months	B & C	36,611	9,139
31st Power Cycle	360 - 378 months			
31st Outage	378 - 380 months	B & C	33,752	7,796
32nd Power Cycle	380 - 398 months			
32nd Outage	398 - 400 months	B & C	31,115	6,651
33rd Power Cycle	400 - 418 months			
33rd Outage	418 - 420 months	B & C	28,685	5,674
34th Power Cycle	420 - 438 months			
34th Outage	438 - 440 months	B & C	26,444	4,841
35th Power Cycle	440 - 458 months			
35th Outage	458 - 460 months	B & C	24,378	4,130
36th Power Cycle	460 - 478 months			
Shutdown	478 - 480 months	none	0	0
Total Net Present Values			2,162,663	1,133,916

Alternative 8: 40-Year Test Cycle - 20-Year License Extensions
Current Leakage Criteria and ILRT Frequency, Reduced LLRTs

Type B & C Tests (LLRTs) = \$70,000 per test
Type A Tests (ILRTs) = \$1,890,000 per test

Period	Duration	Tests Required	Costs 5% Discount	Costs 10% Discount
13th Power Cycle	0 - 18 months			
13th Outage	18 - 20 months	B & C	65,059	60,674
14th Power Cycle	20 - 38 months			
14th Outage	38 - 40 months	A + B & C	1,619,377	1,397,561
15th Power Cycle	40 - 58 months			
15th Outage	58 - 60 months	B & C	55,292	44,158
16th Power Cycle	60 - 78 months			
16th Outage	78 - 80 months	A + B & C	1,376,264	1,017,139
17th Power Cycle	80 - 98 months			
17th Outage	98 - 100 months	B & C	46,991	32,138
18th Power Cycle	100 - 118 months			
18th Outage	118 - 120 months	A + B & C	1,169,649	740,270
19th Power Cycle	120 - 138 months			
19th Outage	138 - 140 months	B & C	39,936	23,390
20th Power Cycle	140 - 158 months			
20th Outage	158 - 160 months	A + B & C	994,053	538,765
21st Power Cycle	160 - 178 months			
21st Outage	178 - 180 months	B & C	33,941	17,023
22nd Power Cycle	180 - 198 months			
22nd Outage	198 - 200 months	A + B & C	844,818	392,111
23rd Power Cycle	200 - 218 months			
23rd Outage	218 - 220 months	B & C	28,845	12,389
24th Power Cycle	218 - 238 months			
24th Outage	238 - 240 months	A + B & C	717,988	285,377
25th Power Cycle	240 - 258 months			
25th Outage	258 - 260 months	B & C	24,515	9,017
26th Power Cycle	260 - 278 months			
26th Outage	278 - 280 months	A + B & C	610,198	207,696
27th Power Cycle	280 - 298 months			
27th Outage	298 - 300 months	B & C	20,835	6,563
28th Power Cycle	300 - 318 months			
28th Outage	318 - 320 months	A + B & C	518,591	151,160
29th Power Cycle	320 - 338 months			
29th Outage	338 - 340 months	B & C	17,707	4,776
30th Power Cycle	340 - 358 months			
30th Outage	358 - 360 months	A + B & C	440,736	110,014
31st Power Cycle	360 - 378 months			
31st Outage	378 - 380 months	B & C	15,048	3,476
32nd Power Cycle	380 - 398 months			
32nd Outage	398 - 400 months	A + B & C	374,570	80,068
33rd Power Cycle	400 - 418 months			
33rd Outage	418 - 420 months	B & C	12,789	2,530
34th Power Cycle	420 - 438 months			
34th Outage	438 - 440 months	A + B & C	318,336	58,273
35th Power Cycle	440 - 458 months			
35th Outage	458 - 460 months	B & C	10,869	1,841
36th Power Cycle Shutdown	460 - 480 months	none	0	0
Total Net Present Values			9,356,407	5,196,409

Alternative 9: 40-Year Test Cycle - 20-Year License Extensions
Relaxed Leakage Criteria, Reduced LLRTs

Type B & C Tests (LLRTs) = \$67,000 per test
Type A Tests (ILRTs) = \$1,690,000 per test

Period	Duration	Tests Required	Costs 5% Discount	Costs 10% Discount
13th Power Cycle	0 - 18 months			
13th Outage	18 - 20 months	B & C	62,271	58,074
14th Power Cycle	20 - 38 months			
14th Outage	38 - 40 months	A + B & C	1,448,014	1,249,671
15th Power Cycle	40 - 58 months			
15th Outage	58 - 60 months	B & C	52,922	42,266
16th Power Cycle	60 - 78 months			
16th Outage	78 - 80 months	A + B & C	1,230,628	909,506
17th Power Cycle	80 - 98 months			
17th Outage	98 - 100 months	B & C	44,977	30,761
18th Power Cycle	100 - 118 months			
18th Outage	118 - 120 months	A + B & C	1,045,877	661,934
19th Power Cycle	120 - 138 months			
19th Outage	138 - 140 months	B & C	38,225	22,388
20th Power Cycle	140 - 158 months			
20th Outage	158 - 160 months	A + B & C	888,862	481,753
21st Power Cycle	160 - 178 months			
21st Outage	178 - 180 months	B & C	32,486	16,294
22nd Power Cycle	180 - 198 months			
22nd Outage	198 - 200 months	A + B & C	755,420	350,618
23rd Power Cycle	200 - 218 months			
23rd Outage	218 - 220 months	B & C	27,609	11,858
24th Power Cycle	218 - 238 months			
24th Outage	238 - 240 months	A + B & C	642,010	255,178
25th Power Cycle	240 - 258 months			
25th Outage	258 - 260 months	B & C	23,464	8,631
26th Power Cycle	260 - 278 months			
26th Outage	278 - 280 months	A + B & C	545,627	185,718
27th Power Cycle	280 - 298 months			
27th Outage	298 - 300 months	B & C	19,942	6,281
28th Power Cycle	300 - 318 months			
28th Outage	318 - 320 months	A + B & C	463,714	135,165
29th Power Cycle	320 - 338 months			
29th Outage	338 - 340 months	B & C	16,948	4,571
30th Power Cycle	340 - 358 months			
30th Outage	358 - 360 months	A + B & C	394,097	98,372
31st Power Cycle	360 - 378 months			
31st Outage	378 - 380 months	B & C	14,404	3,327
32nd Power Cycle	380 - 398 months			
32nd Outage	398 - 400 months	A + B & C	334,933	71,595
33rd Power Cycle	400 - 418 months			
33rd Outage	418 - 420 months	B & C	12,241	2,421
34th Power Cycle	420 - 438 months			
34th Outage	438 - 440 months	A + B & C	284,650	52,106
35th Power Cycle	440 - 458 months			
35th Outage	458 - 460 months	B & C	10,403	1,762
36th Power Cycle	460 - 478 months			
Shutdown	478 - 480 months	none	0	0
Total Net Present Values			8,389,724	4,660,250

Alternative 10: 40-Year Test Cycle - 20-Year License Extensions
 Current Leakage Criteria, 2 ILRTs/10 Years, Reduced LLRTs

Type B & C Tests (LLRTs) = \$70,000 per test
 Type A Tests (ILRTs) = \$1,890,000 per test

Period	Duration	Tests Required	Costs 5% Discount	Costs 10% Discount
13th Power Cycle	0 - 18 months			
13th Outage	18 - 20 months	B & C	65,059	60,674
14th Power Cycle	20 - 38 months			
14th Outage	38 - 40 months	B & C	59,977	51,762
15th Power Cycle	40 - 58 months			
15th Outage	58 - 60 months	A + B & C	1,492,880	1,192,273
16th Power Cycle	60 - 78 months			
16th Outage	78 - 80 months	B & C	50,973	37,672
17th Power Cycle	80 - 98 months			
17th Outage	98 - 100 months	B & C	46,991	32,138
18th Power Cycle	100 - 118 months			
18th Outage	118 - 120 months	A + B & C	1,169,649	740,270
19th Power Cycle	120 - 138 months			
19th Outage	138 - 140 months	B & C	39,936	23,390
20th Power Cycle	140 - 158 months			
20th Outage	158 - 160 months	B & C	36,817	19,954
21st Power Cycle	160 - 178 months			
21st Outage	178 - 180 months	A + B & C	916,403	459,626
22nd Power Cycle	180 - 198 months			
22nd Outage	198 - 200 months	B & C	31,290	14,523
23rd Power Cycle	200 - 218 months			
23rd Outage	218 - 220 months	B & C	28,845	12,389
24th Power Cycle	218 - 238 months			
24th Outage	238 - 240 months	A + B & C	717,988	285,377
25th Power Cycle	240 - 258 months			
25th Outage	258 - 260 months	B & C	24,515	9,017
26th Power Cycle	260 - 278 months			
26th Outage	278 - 280 months	B & C	22,600	7,692
27th Power Cycle	280 - 298 months			
27th Outage	298 - 300 months	A + B & C	562,533	177,188
28th Power Cycle	300 - 318 months			
28th Outage	318 - 320 months	B & C	19,207	5,599
29th Power Cycle	320 - 338 months			
29th Outage	338 - 340 months	B & C	17,707	4,776
30th Power Cycle	340 - 358 months			
30th Outage	358 - 360 months	A + B & C	440,736	110,014
31st Power Cycle	360 - 378 months			
31st Outage	378 - 380 months	B & C	15,048	3,476
32nd Power Cycle	380 - 398 months			
32nd Outage	398 - 400 months	B & C	13,873	2,965
33rd Power Cycle	400 - 418 months			
33rd Outage	418 - 420 months	A + B & C	345,310	68,306
34th Power Cycle	420 - 438 months			
34th Outage	438 - 440 months	B & C	11,790	2,158
35th Power Cycle	440 - 458 months			
35th Outage	458 - 460 months	B & C	10,869	1,841
36th Power Cycle	460 - 478 months			
Shutdown	478 - 480 months	none	0	0
Total Net Present Values			6,140,996	3,323,080

Alternative 11: 40-Year Test Cycle - 20-Year License Extensions
 Relaxed Leakage Criteria, 2 ILRTs/10 Years, Reduced LLRTs

Type B & C Tests (LLRTs) = \$67,000 per test
 Type A Tests (ILRTs) = \$1,690,000 per test

Period	Duration	Tests Required	Costs 5% Discount	Costs 10% Discount
13th Power Cycle	0 - 18 months			
13th Outage	18 - 20 months	B & C	62,271	58,074
14th Power Cycle	20 - 38 months			
14th Outage	38 - 40 months	B & C	57,406	49,543
15th Power Cycle	40 - 58 months			
15th Outage	58 - 60 months	A + B & C	1,334,903	1,066,106
16th Power Cycle	60 - 78 months			
16th Outage	78 - 80 months	B & C	48,788	36,057
17th Power Cycle	80 - 98 months			
17th Outage	98 - 100 months	B & C	44,977	30,761
18th Power Cycle	100 - 118 months			
18th Outage	118 - 120 months	A + B & C	1,045,877	661,934
19th Power Cycle	120 - 138 months			
19th Outage	138 - 140 months	B & C	38,225	22,388
20th Power Cycle	140 - 158 months			
20th Outage	158 - 160 months	B & C	35,239	19,099
21st Power Cycle	160 - 178 months			
21st Outage	178 - 180 months	A + B & C	819,429	410,988
22nd Power Cycle	180 - 198 months			
22nd Outage	198 - 200 months	B & C	29,949	13,900
23rd Power Cycle	200 - 218 months			
23rd Outage	218 - 220 months	B & C	27,609	11,858
24th Power Cycle	218 - 238 months			
24th Outage	238 - 240 months	A + B & C	642,010	255,178
25th Power Cycle	240 - 258 months			
25th Outage	258 - 260 months	B & C	23,464	8,631
26th Power Cycle	260 - 278 months			
26th Outage	278 - 280 months	B & C	21,631	7,363
27th Power Cycle	280 - 298 months			
27th Outage	298 - 300 months	A + B & C	503,006	158,438
28th Power Cycle	300 - 318 months			
28th Outage	318 - 320 months	B & C	18,384	5,359
29th Power Cycle	320 - 338 months			
29th Outage	338 - 340 months	B & C	16,948	4,571
30th Power Cycle	340 - 358 months			
30th Outage	358 - 360 months	A + B & C	394,097	98,372
31st Power Cycle	360 - 378 months			
31st Outage	378 - 380 months	B & C	14,404	3,327
32nd Power Cycle	380 - 398 months			
32nd Outage	398 - 400 months	B & C	13,278	2,838
33rd Power Cycle	400 - 418 months			
33rd Outage	418 - 420 months	A + B & C	308,769	61,078
34th Power Cycle	420 - 438 months			
34th Outage	438 - 440 months	B & C	11,285	2,066
35th Power Cycle	440 - 458 months			
35th Outage	458 - 460 months	B & C	10,403	1,762
36th Power Cycle	460 - 478 months			
Shutdown	478 - 480 months	none	0	0
Total Net Present Values			5,522,352	2,989,691

Alternative 12: 40-Year Test Cycle - 20-Year License Extensions
 Current Leakage Criteria, 1 ILRT/10 Years, Reduced LLRTs

Type B & C Tests (LLRTs) = \$70,000 per test
 Type A Tests (ILRTs) = \$1,890,000 per test

Period	Duration	Tests Required	Costs 5% Discount	Costs 10% Discount
13th Power Cycle	0 - 18 months			
13th Outage	18 - 20 months	B & C	65,059	60,674
14th Power Cycle	20 - 38 months			
14th Outage	38 - 40 months	B & C	59,977	51,762
15th Power Cycle	40 - 58 months			
15th Outage	58 - 60 months	B & C	55,292	44,158
16th Power Cycle	60 - 78 months			
16th Outage	78 - 80 months	B & C	50,973	37,672
17th Power Cycle	80 - 98 months			
17th Outage	98 - 100 months	B & C	46,991	32,138
18th Power Cycle	100 - 118 months			
18th Outage	118 - 120 months	A + B & C	1,169,649	740,270
19th Power Cycle	120 - 138 months			
19th Outage	138 - 140 months	B & C	39,936	23,390
20th Power Cycle	140 - 158 months			
20th Outage	158 - 160 months	B & C	36,817	19,954
21st Power Cycle	160 - 178 months			
21st Outage	178 - 180 months	B & C	33,941	17,023
22nd Power Cycle	180 - 198 months			
22nd Outage	198 - 200 months	B & C	31,290	14,523
23rd Power Cycle	200 - 218 months			
23rd Outage	218 - 220 months	B & C	28,845	12,389
24th Power Cycle	218 - 238 months			
24th Outage	238 - 240 months	A + B & C	717,988	285,377
25th Power Cycle	240 - 258 months			
25th Outage	258 - 260 months	B & C	24,515	9,017
26th Power Cycle	260 - 278 months			
26th Outage	278 - 280 months	B & C	22,600	7,692
27th Power Cycle	280 - 298 months			
27th Outage	298 - 300 months	B & C	20,835	6,563
28th Power Cycle	300 - 318 months			
28th Outage	318 - 320 months	B & C	19,207	5,599
29th Power Cycle	320 - 338 months			
29th Outage	338 - 340 months	B & C	17,707	4,776
30th Power Cycle	340 - 358 months			
30th Outage	358 - 360 months	A + B & C	440,736	110,014
31st Power Cycle	360 - 378 months			
31st Outage	378 - 380 months	B & C	15,048	3,476
32nd Power Cycle	380 - 398 months			
32nd Outage	398 - 400 months	B & C	13,873	2,965
33rd Power Cycle	400 - 418 months			
33rd Outage	418 - 420 months	B & C	12,789	2,530
34th Power Cycle	420 - 438 months			
34th Outage	438 - 440 months	B & C	11,790	2,158
35th Power Cycle	440 - 458 months			
35th Outage	458 - 460 months	B & C	10,869	1,841
36th Power Cycle	460 - 478 months			
Shutdown	478 - 480 months	none	0	0
Total Net Present Values			2,946,727	1,495,961

Alternative 13: 40-Year Test Cycle - 20-Year License Extensions
 Relaxed Leakage Criteria, 1 ILRT/10 Years, Reduced LLRTs

Type B & C Tests (LLRTs) = \$67,000 per test
 Type A Tests (ILRTs) = \$1,690,000 per test

Period	Duration	Tests Required	Costs 5% Discount	Costs 10% Discount
13th Power Cycle	0 - 18 months			
13th Outage	18 - 20 months	B & C	62,271	58,074
14th Power Cycle	20 - 38 months			
14th Outage	38 - 40 months	B & C	57,406	49,543
15th Power Cycle	40 - 58 months			
15th Outage	58 - 60 months	B & C	52,922	42,266
16th Power Cycle	60 - 78 months			
16th Outage	78 - 80 months	B & C	48,788	36,057
17th Power Cycle	80 - 98 months			
17th Outage	98 - 100 months	B & C	44,977	30,761
18th Power Cycle	100 - 118 months			
18th Outage	118 - 120 months	A + B & C	1,045,877	661,934
19th Power Cycle	120 - 138 months			
19th Outage	138 - 140 months	B & C	38,225	22,388
20th Power Cycle	140 - 158 months			
20th Outage	158 - 160 months	B & C	35,239	19,099
21st Power Cycle	160 - 178 months			
21st Outage	178 - 180 months	B & C	32,486	16,294
22nd Power Cycle	180 - 198 months			
22nd Outage	198 - 200 months	B & C	29,949	13,900
23rd Power Cycle	200 - 218 months			
23rd Outage	218 - 220 months	B & C	27,609	11,858
24th Power Cycle	218 - 238 months			
24th Outage	238 - 240 months	A + B & C	642,010	255,178
25th Power Cycle	240 - 258 months			
25th Outage	258 - 260 months	B & C	23,464	8,631
26th Power Cycle	260 - 278 months			
26th Outage	278 - 280 months	B & C	21,631	7,363
27th Power Cycle	280 - 298 months			
27th Outage	298 - 300 months	B & C	19,942	6,281
28th Power Cycle	300 - 318 months			
28th Outage	318 - 320 months	B & C	18,384	5,359
29th Power Cycle	320 - 338 months			
29th Outage	338 - 340 months	B & C	16,948	4,571
30th Power Cycle	340 - 358 months			
30th Outage	358 - 360 months	A + B & C	394,097	98,372
31st Power Cycle	360 - 378 months			
31st Outage	378 - 380 months	B & C	14,404	3,327
32nd Power Cycle	380 - 398 months			
32nd Outage	398 - 400 months	B & C	13,278	2,838
33rd Power Cycle	400 - 418 months			
33rd Outage	418 - 420 months	B & C	12,241	2,421
34th Power Cycle	420 - 438 months			
34th Outage	438 - 440 months	B & C	11,285	2,066
35th Power Cycle	440 - 458 months			
35th Outage	458 - 460 months	B & C	10,403	1,762
36th Power Cycle	460 - 478 months			
Shutdown	478 - 480 months	none	0	0
Total Net Present Values			2,673,836	1,360,343

Alternative 14: 40-Year Test Cycle - 20-Year License Extensions
 Current Leakage Criteria, 1 ILRT/20 Years, Reduced LLRTs

Type B & C Tests (LLRTs) = \$70,000 per test
 Type A Tests (ILRTs) = \$1,890,000 per test

Period	Duration	Tests Required	Costs 5% Discount	Costs 10% Discount
13th Power Cycle	0 - 18 months			
13th Outage	18 - 20 months	B & C	65,059	60,674
14th Power Cycle	20 - 38 months			
14th Outage	38 - 40 months	B & C	59,977	51,762
15th Power Cycle	40 - 58 months			
15th Outage	58 - 60 months	B & C	55,292	44,158
16th Power Cycle	60 - 78 months			
16th Outage	78 - 80 months	B & C	50,973	37,672
17th Power Cycle	80 - 98 months			
17th Outage	98 - 100 months	B & C	46,991	32,138
18th Power Cycle	100 - 118 months			
18th Outage	118 - 120 months	B & C	43,320	27,417
19th Power Cycle	120 - 138 months			
19th Outage	138 - 140 months	B & C	39,936	23,390
20th Power Cycle	140 - 158 months			
20th Outage	158 - 160 months	B & C	36,817	19,954
21st Power Cycle	160 - 178 months			
21st Outage	178 - 180 months	B & C	33,941	17,023
22nd Power Cycle	180 - 198 months			
22nd Outage	198 - 200 months	B & C	31,290	14,523
23rd Power Cycle	200 - 218 months			
23rd Outage	218 - 220 months	B & C	28,845	12,389
24th Power Cycle	218 - 238 months			
24th Outage	238 - 240 months	A + B & C	717,988	285,377
25th Power Cycle	240 - 258 months			
25th Outage	258 - 260 months	B & C	24,515	9,017
26th Power Cycle	260 - 278 months			
26th Outage	278 - 280 months	B & C	22,600	7,692
27th Power Cycle	280 - 298 months			
27th Outage	298 - 300 months	B & C	20,835	6,563
28th Power Cycle	300 - 318 months			
28th Outage	318 - 320 months	B & C	19,207	5,599
29th Power Cycle	320 - 338 months			
29th Outage	338 - 340 months	B & C	17,707	4,776
30th Power Cycle	340 - 358 months			
30th Outage	358 - 360 months	B & C	16,324	4,075
31st Power Cycle	360 - 378 months			
31st Outage	378 - 380 months	B & C	15,048	3,476
32nd Power Cycle	380 - 398 months			
32nd Outage	398 - 400 months	B & C	13,873	2,965
33rd Power Cycle	400 - 418 months			
33rd Outage	418 - 420 months	B & C	12,789	2,530
34th Power Cycle	420 - 438 months			
34th Outage	438 - 440 months	B & C	11,790	2,158
35th Power Cycle	440 - 458 months			
35th Outage	458 - 460 months	B & C	10,869	1,841
36th Power Cycle	460 - 478 months			
Shutdown	478 - 480 months	none	0	0
Total Net Present Values			1,395,986	677,169

Alternative 15: 40-Year Test Cycle - 20-Year License Extensions
 Relaxed Leakage Criteria, 1 ILRT/20 Years, Reduced LLRTs

Type B & C Tests (LLRTs) =
 Type A Tests (ILRTs) =

\$67,000 per test
 \$1,690,000 per test

Period	Duration	Tests Required	Costs 5% Discount	Costs 10% Discount
13th Power Cycle	0 - 18 months			
13th Outage	18 - 20 months	B & C	62,271	58,074
14th Power Cycle	20 - 38 months			
14th Outage	38 - 40 months	B & C	57,406	49,543
15th Power Cycle	40 - 58 months			
15th Outage	58 - 60 months	B & C	52,922	42,266
16th Power Cycle	60 - 78 months			
16th Outage	78 - 80 months	B & C	48,788	36,057
17th Power Cycle	80 - 98 months			
17th Outage	98 - 100 months	B & C	44,977	30,761
18th Power Cycle	100 - 118 months			
18th Outage	118 - 120 months	B & C	41,464	26,242
19th Power Cycle	120 - 138 months			
19th Outage	138 - 140 months	B & C	38,225	22,388
20th Power Cycle	140 - 158 months			
20th Outage	158 - 160 months	B & C	35,239	19,099
21st Power Cycle	160 - 178 months			
21st Outage	178 - 180 months	B & C	32,486	16,294
22nd Power Cycle	180 - 198 months			
22nd Outage	198 - 200 months	B & C	29,949	13,900
23rd Power Cycle	200 - 218 months			
23rd Outage	218 - 220 months	B & C	27,609	11,858
24th Power Cycle	218 - 238 months			
24th Outage	238 - 240 months	A + B & C	642,010	255,178
25th Power Cycle	240 - 258 months			
25th Outage	258 - 260 months	B & C	23,464	8,631
26th Power Cycle	260 - 278 months			
26th Outage	278 - 280 months	B & C	21,631	7,363
27th Power Cycle	280 - 298 months			
27th Outage	298 - 300 months	B & C	19,942	6,281
28th Power Cycle	300 - 318 months			
28th Outage	318 - 320 months	B & C	18,384	5,359
29th Power Cycle	320 - 338 months			
29th Outage	338 - 340 months	B & C	16,948	4,571
30th Power Cycle	340 - 358 months			
30th Outage	358 - 360 months	B & C	15,624	3,900
31st Power Cycle	360 - 378 months			
31st Outage	378 - 380 months	B & C	14,404	3,327
32nd Power Cycle	380 - 398 months			
32nd Outage	398 - 400 months	B & C	13,278	2,838
33rd Power Cycle	400 - 418 months			
33rd Outage	418 - 420 months	B & C	12,241	2,421
34th Power Cycle	420 - 438 months			
34th Outage	438 - 440 months	B & C	11,285	2,066
35th Power Cycle	440 - 458 months			
35th Outage	458 - 460 months	B & C	10,403	1,762
36th Power Cycle Shutdown	460 - 478 months 478 - 480 months	none	0	0
Total Net Present Values			1,290,950	630,179

APPENDIX E

**DEPENDENCE OF ENVIRONMENTAL SOURCE TERMS ON
CONTAINMENT LEAKAGE**

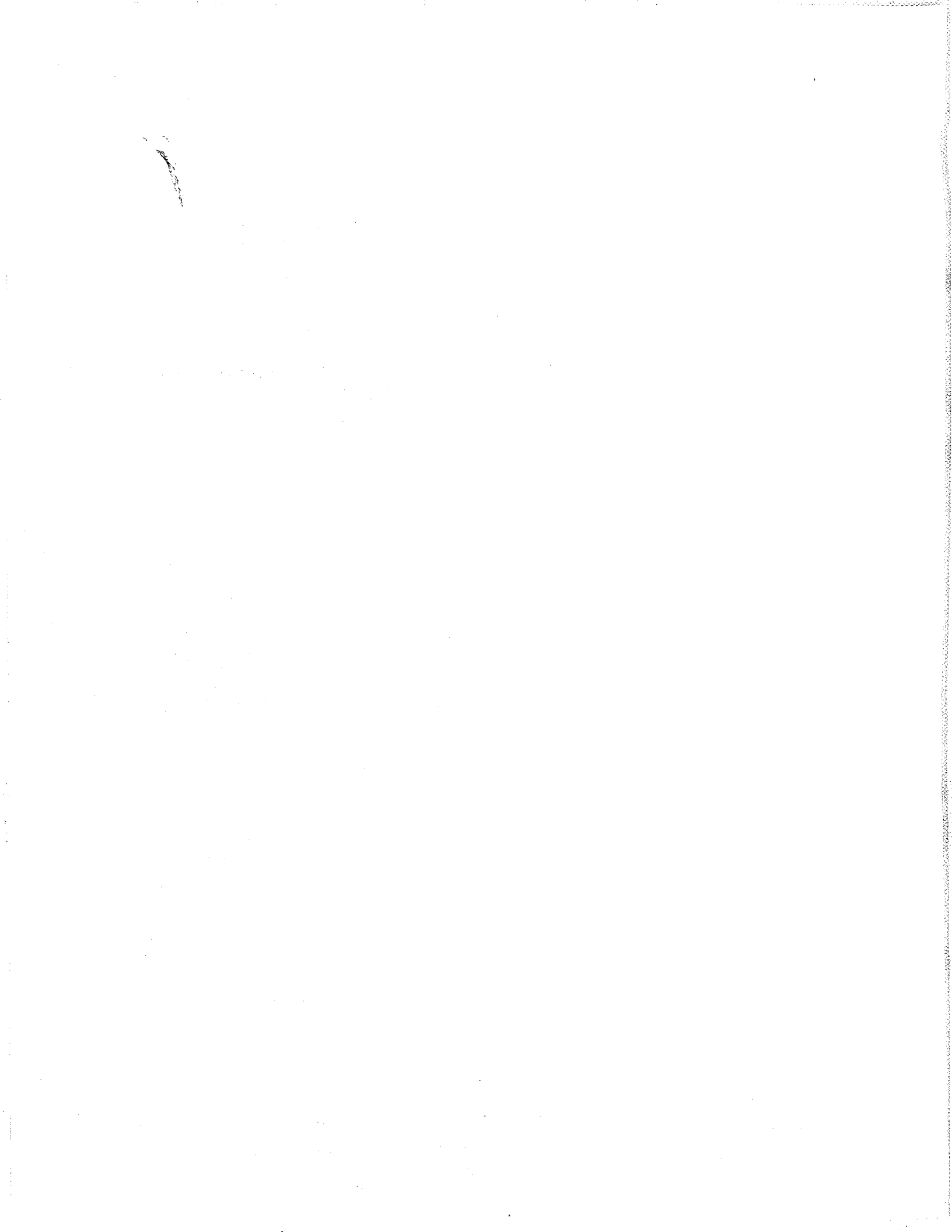

Contents

Tables

<u>Number</u>		<u>Page</u>
E-1	Source Terms for Surry	E-3

Figures

<u>Number</u>		<u>Page</u>
E-1	Impact of Leakage on Source Terms	E-5

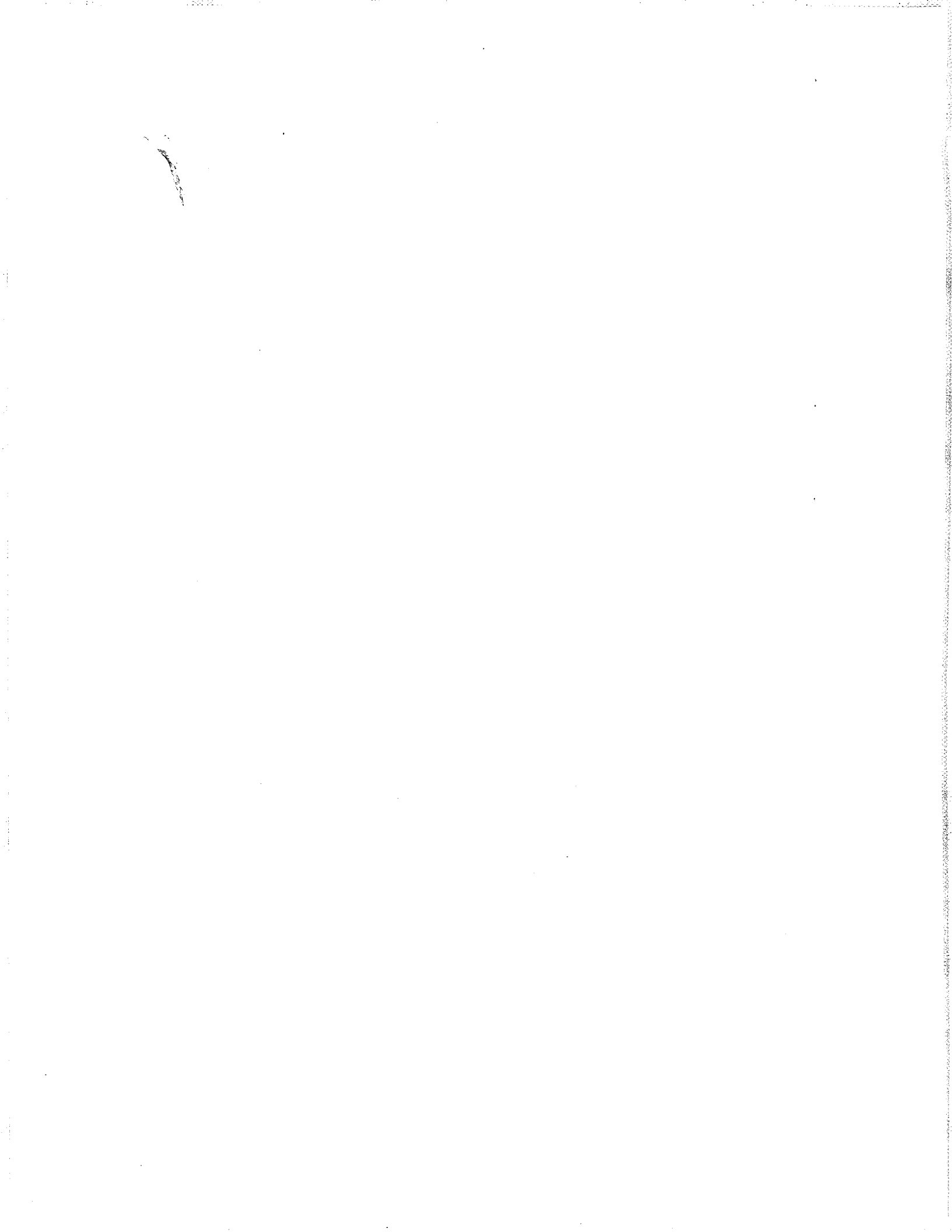

APPENDIX E

DEPENDENCE OF ENVIRONMENTAL SOURCE TERMS ON CONTAINMENT LEAKAGE

In order to help explain the nature of the derived dependence of reactor accident risks on the assumed containment leakage rate developed in Chapter 5, it is useful to consider the relationship between fission product losses from the containment by leakage and removal

from the containment atmosphere by various deposition mechanisms.

The following differential equation describes the time dependent concentration of airborne fission products in a single well-mixed volume:

$$d/dt C_i = - (\Sigma \lambda_{ij}) C_i - \alpha_i C_i + S_i(t) \quad (1)$$

where,

- C_i = airborne concentration of component i
- λ_{ij} = removal rate constant for component i due to mechanism j
- Σ = summation over all applicable removal mechanisms
- α_i = leakage rate of component i, fraction of the volume per unit time
- $S_i(t)$ = source into containment of component i

The above expression is quite general, but deceptively simple. It applies to fission product gases, vapors and aerosols. Its application to severe accident situations involving many removal mechanisms, each of which is time- and species-dependent, multiple containment compartments, species-dependent timing of releases, etc., can become exceedingly complex. Numerous computer codes, such as the Source Term Code Package (GIE90), MELCOR (SNL91), and CONTAIN (NRC85A) have been developed to analyze these processes. In its most general form, the

solution to the seemingly simple equation above can require very extensive computing capability as well as substantial computer time.

For the present purposes, a number of simplifying assumptions can be made to illustrate some key points. If we consider only a single generic airborne species, assume constant removal, leakage and source terms, simplify the expression by dropping the explicit summation over all removal terms, and set the initial condition of $C = C_0$ at $t = t_0$, the above equation is easily solved to yield

$$C = S/(\lambda + \alpha) - [S/(\lambda + \alpha) - C_0] \exp -(\lambda + \alpha)(t - t_0) \quad (2)$$

The leaked amount during any time interval $t - t_0$ is then given by the integral

$$L = \int_{t_0}^t C V \alpha dt \quad (3)$$

where V is the volume of the containment.

Or,

$$L = [(SV\alpha)/(\lambda + \alpha)]\Delta t - \{[S/(\lambda + \alpha) - C_0] (\alpha V)/(\lambda + \alpha)\} \\ \times \{1 - \exp[-(\lambda + \alpha)\Delta t]\} \quad (4)$$

If we make the further simplifying assumption that there is no time-dependent source term to the containment, with all of the source

available initially, the expression for the leaked amount reduces to

$$L = C_0 [(\alpha V)/(\lambda + \alpha)] \{1 - \exp[-(\lambda + \alpha)\Delta t]\} \quad (5)$$

The latter assumption is tantamount to saying that the release period to the containment is short compared to the release period from the containment to the environment. This assumption is quite reasonable since in typical severe accident scenarios the releases to the containment take place over a few hours, whereas the environmental releases are assessed over about 24 hours. The long leakage durations are particularly relevant to scenarios in which the containment stays intact.

involved and the roles of the competing mechanisms for fission product removal from the containment atmosphere. Such simplifying assumptions would not necessarily be generally applicable to the analysis of severe accident scenarios.

The last expression can now be easily examined to explore the relationship between leakage and the other removal mechanisms.

All of the above simplifying assumption are made to illustrate the essential physics

If it is assumed that the leakage term, α , is much smaller than the removal term, λ , (e.g., $\alpha = 0.1\lambda$), the above expression reduces to approximately

$$L = C_0 (\alpha V/1.1\lambda) \{1 - \exp[-(1.1\lambda\Delta t)]\} \quad (6)$$

For the leakage term, α , approximately equal to the removal term, λ , Equation 5 reduces to approximately

$$L = C_0 (V/2) \{1 - \exp[-(2\lambda\Delta t)]\} \quad (7)$$

And for the leakage term, α , much bigger than the removal term, λ , (e.g., $\alpha = 10\lambda$), Equation 5 reduces to approximately

$$L = C_0 (V) \{1 - \exp[-(11\lambda \Delta t)]\} \quad (8)$$

If we next examine the exponential term in each of the last three expressions, it can be shown that for the conditions of interest all the terms are small and can be neglected for purposes of this discussion. Obviously, for very long times these terms vanish. As a more specific example, WASH-1400 (NRC75), which is generally considered as a conservative treatment of fission product behavior, calculated an effective removal lambda for aerosols under natural deposition conditions of 0.13 per hour. Under the influence of sprays or other removal mechanisms much higher deposition rates were predicted. Substituting this removal lambda into each of the above exponential terms and assuming a 24 hour

duration of release yields exponents of $-(1.1 \times .13 \times 24)$, $-(2 \times .13 \times 24)$, and $-(11 \times .13 \times 24)$, respectively. Thus, it is clear that the exponential terms can be neglected in the discussion of the behavior of fission products that are subject to deposition and other removal mechanisms, even for relatively low deposition rates. This would not be true for the noble gases which are not subject to such removal mechanisms.

The dependence of environmental source terms on the containment leakage rate relative to other removal mechanisms now becomes quite apparent. For containment leakage rates that are small relative to fission product removal

mechanisms, as would be the case for nominal leakage rates, the source terms (leaked amount L in Eqn. 6) are seen to be essentially directly proportional to the leakage rate (α). (A leakage rate of 1 percent per day corresponds to 4.17×10^{-4} loss per hour, in contrast to the 0.13/hr nominal deposition rate.) As fission product losses due to leakage become comparable to other removal mechanisms, the environmental source terms (L) become independent of the leakage rate (α) and, under the foregoing assumptions, approach one-half of the total release to the containment (Eqn. 7). As the leakage is assumed to increase still further, to the point that it dominates other removal processes, environmental source terms are independent of the specific leakage rate and in the limit approach the total releases to the containment (Eqn. 8). These observations are consistent with the dependence of risk on containment leakage developed in Chapter 5.

To lend additional, more quantitative, insight to the environment on containment leakage rate and competing fission product deposition mechanisms, solutions to Equation 5 are presented in Figure E-1. Solutions are shown for removal lambdas of 0, 0.13, and 1.3/hr as functions of the assumed containment leakage rate. A removal lambda of 0 would apply to the noble gases which are not subject to deposition or removal by normal engineered safety features. As noted above, the removal lambda of 0.13/hr is taken from WASH-1400 and was derived for natural deposition of

aerosols. The 1.3/hr value for lambda is an arbitrary increase over the WASH-1400 figure, recognizing that much larger removal rates would be encountered with the operation of engineered safety features. The curves in Figure E-1 are quite consistent with the qualitative discussion presented above. It is noteworthy that the shapes of the curves are very similar to those derived in Chapter 5 to show the dependence of risk on containment leakage rate. This is to be expected since risk measures, particularly for long term effects, should be proportional to the magnitudes of the source terms. The results in Figure E-1 are limited to environmental source terms due to leakage only; the risk results in Chapter 5 include contributions from all containment failure modes.

In Chapter 5, fission product source terms were presented for early containment leakages in the Surry unit. These source terms, repeated below, represent the composite frequency-weighted source terms for all accident scenarios involving early leakage through a 0.1 ft² opening. Comparison of these source terms with the simplified results illustrated in Figure B-1 suggests that the average effective removal lambda for species such as iodine and cesium as inferred from NUREG-1150 is between the 0.13/hr taken from WASH-1400 and the 1.3/hr value assumed for illustration purposes. Thus, the foregoing simplifications have not prevented a meaningful illustration of the essential physics involved.

Table E-1. Source Terms for Surry

Fission Product Group								
NG	I	Cs	Te	Sr	Ru	La	Ce	Ba
No Containment Failure, 1%/day leakage								
.011	1.1E-4	2.1-E8	1.8-E8	4.2-E9	3.4-E10	4.6-E11	5.2-E10	3.5-E9
Early Containment Leakage, 0.1 ft ²								
.44	.075	.064	.036	.0037	8.6-E4	3.1-E4	9.5-E4	.0038

The foregoing simplified analysis of environmental fission product releases as functions of leakage rate and containment

deposition rate has been shown to be consistent with the results of the extremely complex NUREG-1150 analyses.

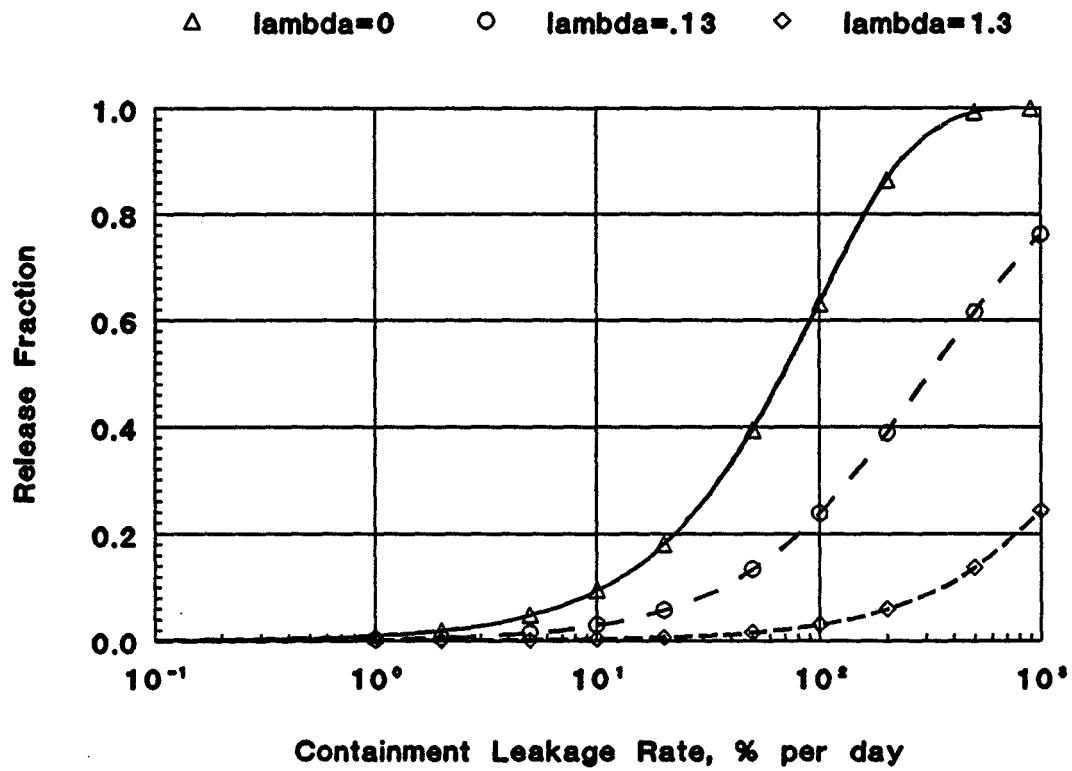
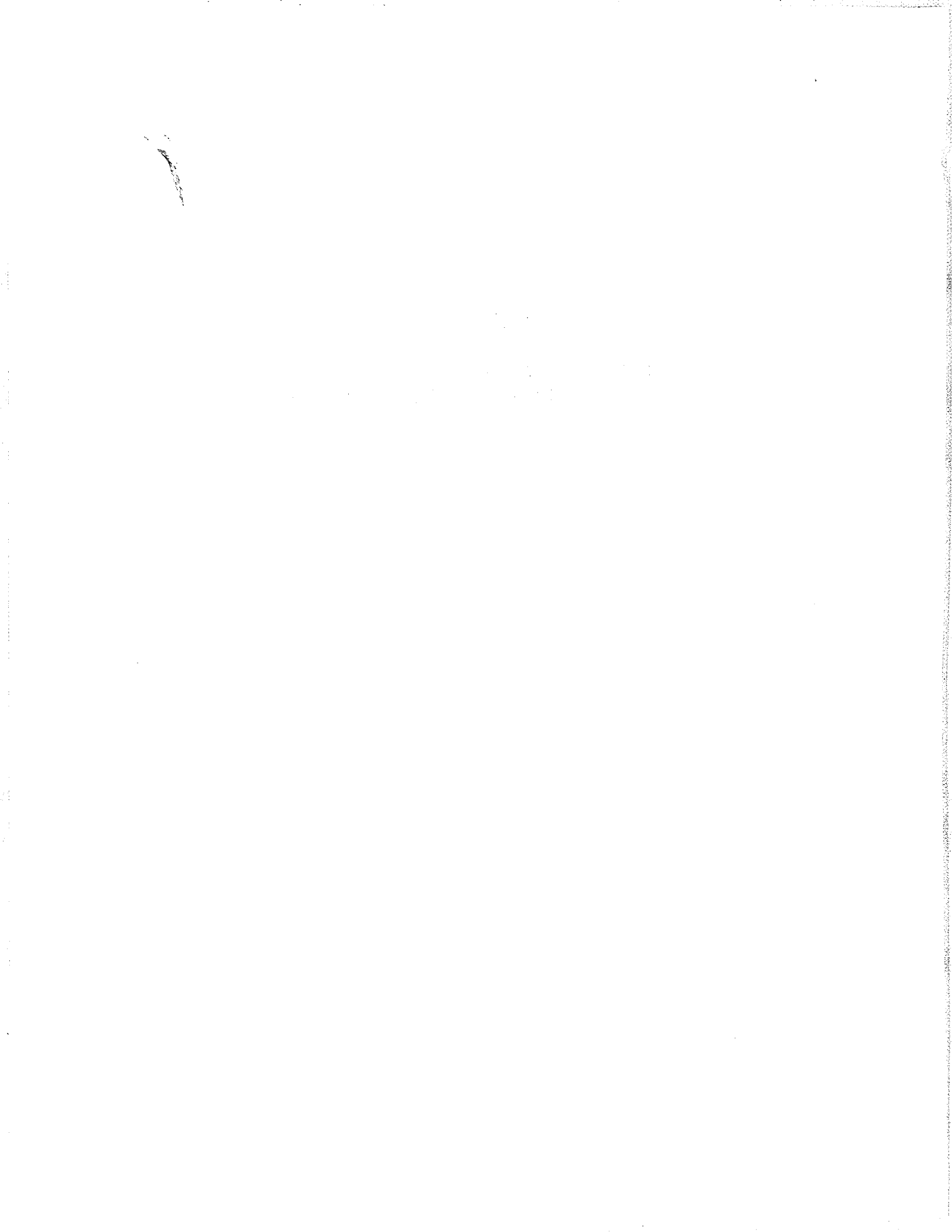
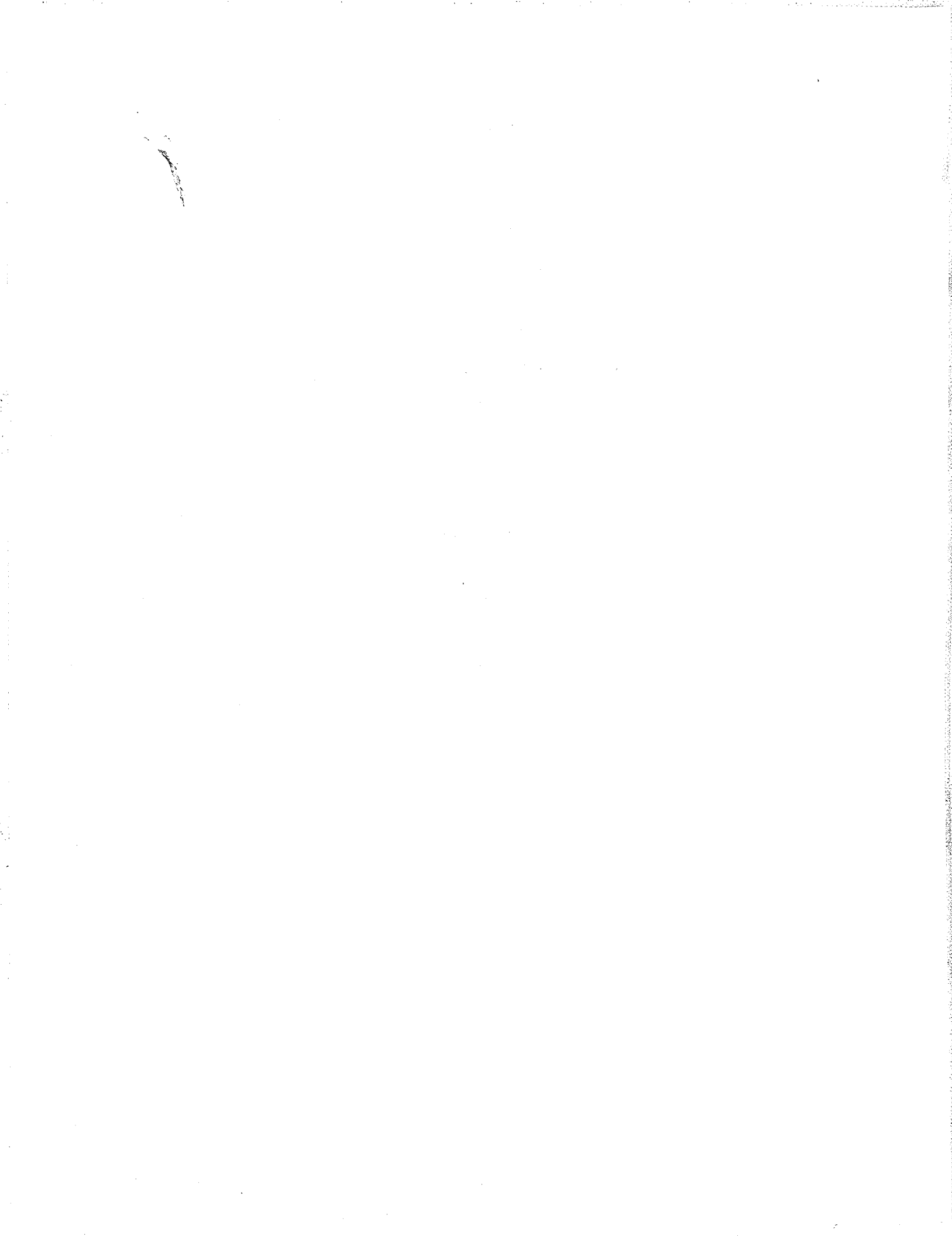

Figure E-1. Impact of Leakage on Source Terms



APPENDIX F

**GRAND GULF NUCLEAR STATION
LOCAL LEAKAGE-RATE TEST PROGRAM**



Contents

	<u>Page</u>
F.1 Purpose	F-1
F.2 Components Required to Be Local Leakage-Rate Tested	F-1
F.3 Test Methods	F-1
F.4 Leakage-Rate Limits	F-1
F.5 Data Analysis	F-9
F.6 Test Frequencies	F-9
F.7 Repair, Replacement and Maintenance	F-10
F.8 Data Package Review	F-11
F.9 General Requirements for Type B & C Results	F-11
F.10 Data Trending and Analysis	F-11

Tables

<u>Number</u>	<u>Page</u>
F-1 Comparison of Performance-Based and Prior Test Programs	F-8

Figures

<u>Number</u>	<u>Page</u>
F-1 Schematic of Performance-Based Program Process	F-2

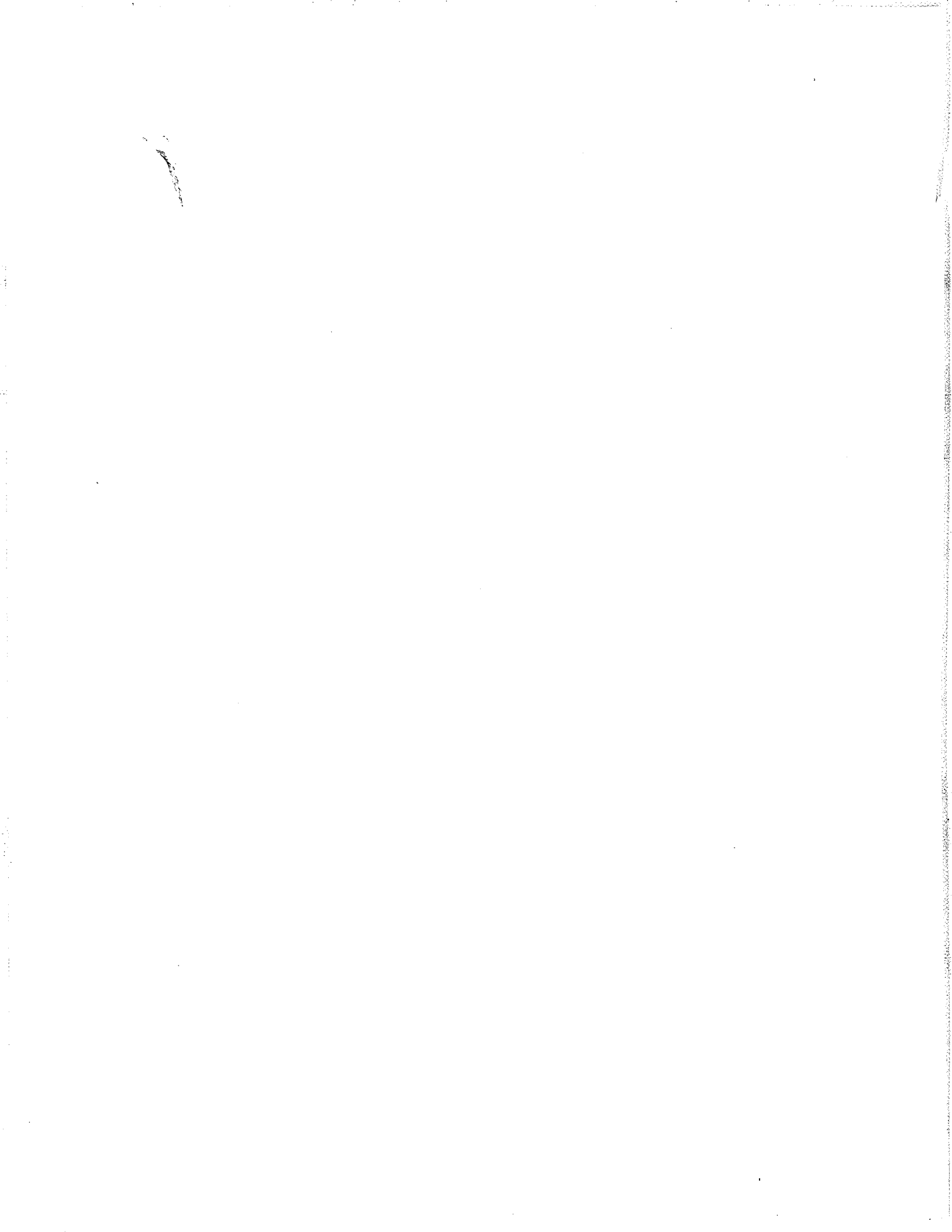

APPENDIX F

GRAND GULF NUCLEAR STATION LOCAL LEAKAGE-RATE TEST PROGRAM

The Grand Gulf Nuclear Station (GGNS) Plant Operations Manual describes the local leakage-rate test program for meeting the requirements of the Appendix J containment leakage-testing requirements. The LLRT Program conducts 316 tests (penetrations, valves and other components) organized into the following categories: the Performance-Based Testing Program (250 components), Fixed-Interval Components (24), Pressure Isolation Valve Tests (24), Drywell Air-lock Tests (4), Drywell Bypass Test (1), Containment ILRT (1), Containment and Drywell Visual Inspection (1), Containment Air-lock Tests (8), and the Containment/Drywell Air-lock Tubing Drop Tests (3).

The following summary is excerpted from the Plant Operations Manual's Performance and Engineering Instruction. By following the requirements and applying the guidance provided in the engineering instructions, Grand Gulf test engineers determined that 149 of a total of 316 components will require LLRTs during the next scheduled unit outage. Of the categories noted above, the greatest reduction in components to be tested was from the Performance-Based Testing Program, where 164 of a total of 250 components will be not be tested in the next outage. Table F-1 provides a comparison of some of the changes brought about by the performance-based program. A schematic of the process is shown in Figure F-1.

F.1 PURPOSE

Among other things, to identify the containment penetrations, valves and components included in the LLRT program, and the applicable test methods, the allowable leakage rates, and testing frequencies.

F.2 COMPONENTS REQUIRED TO BE LOCAL LEAKAGE-RATE TESTED

The instruction provides a table specifying each penetration, valve and component to be tested per Type B and Type C requirements, including the test medium (air, water, nitrogen).

F.3 TEST METHODS

Type B tests shall be performed by local pneumatic pressurization at a pressure not less than P_a . Type C tests shall be performed by local pneumatic pressurization at a pressure of P_a , unless it is a valve sealed with a fluid, which is then tested at a pressure not less than $1.10 P_a$. Test pressurization shall be applied in the same direction as that when the valve would be required to perform its safety function unless it can be determined that direction of pressurization isn't a safety consideration. Certain exceptions to the latter are allowed based on the design of the component. Each valve to be tested shall be closed by normal operation, i.e., without any preliminary exercising or adjustments.

F.4 LEAKAGE-RATE LIMITS

The combined leakage rate of all Type B & C penetrations and valves shall be less than or equal to $0.60 L_a$ when pressurized to greater than or equal to P_a . Some exceptions may apply in the case of valves sealed with fluid from a sealing system. Leakage through main steam isolation valves shall be limited to less than 100 scfh when tested at P_a . The combined leakage rate for all containment isolation valves in hydrostatically-tested lines which penetrate the containment shall be less than or equal to 1 gpm times the total number of valves when tested at

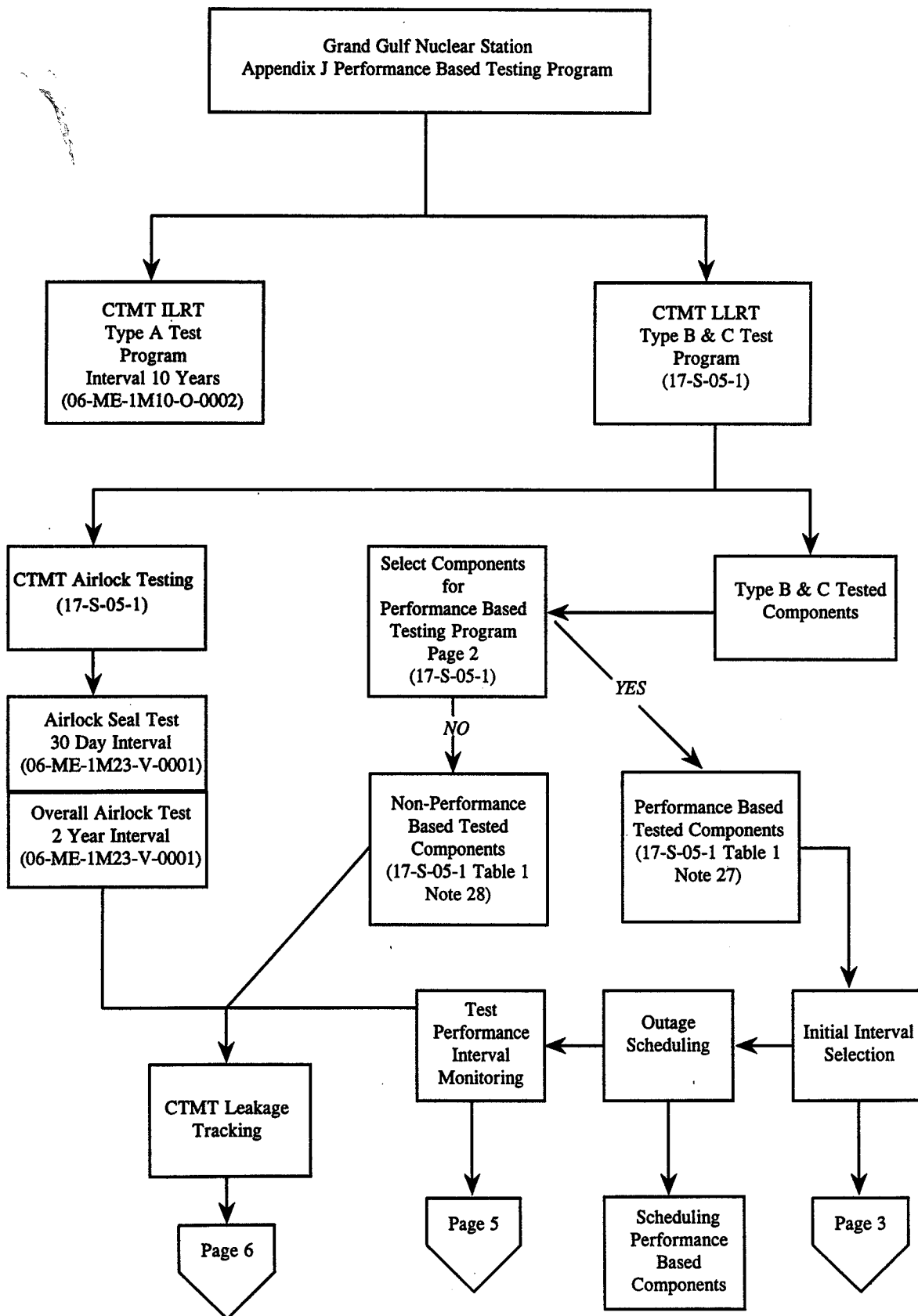

Figure F-1. Schematic of Performance-Based Program Process

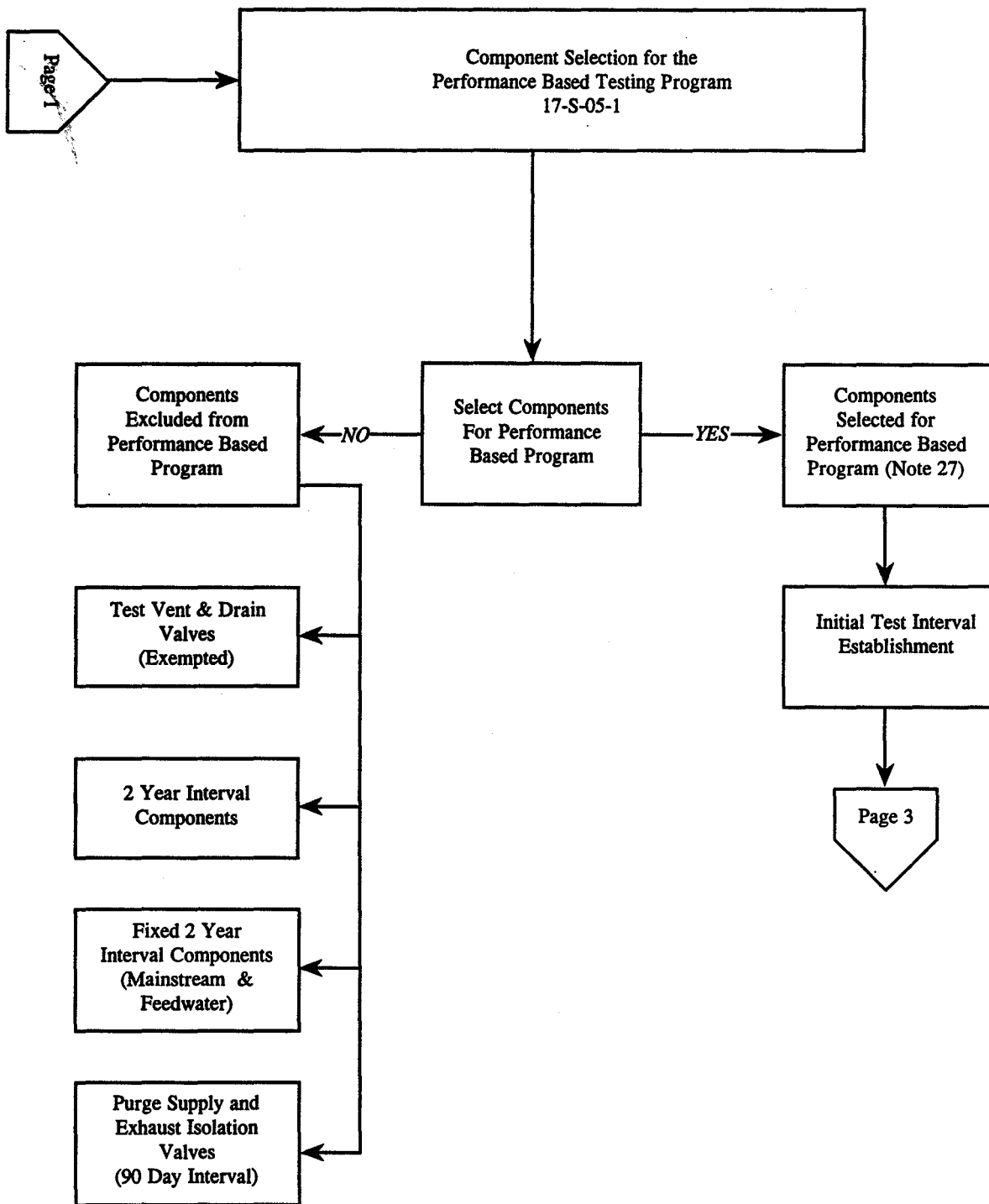

Figure F-1. Schematic of Performance-Based Program Process (Continued)

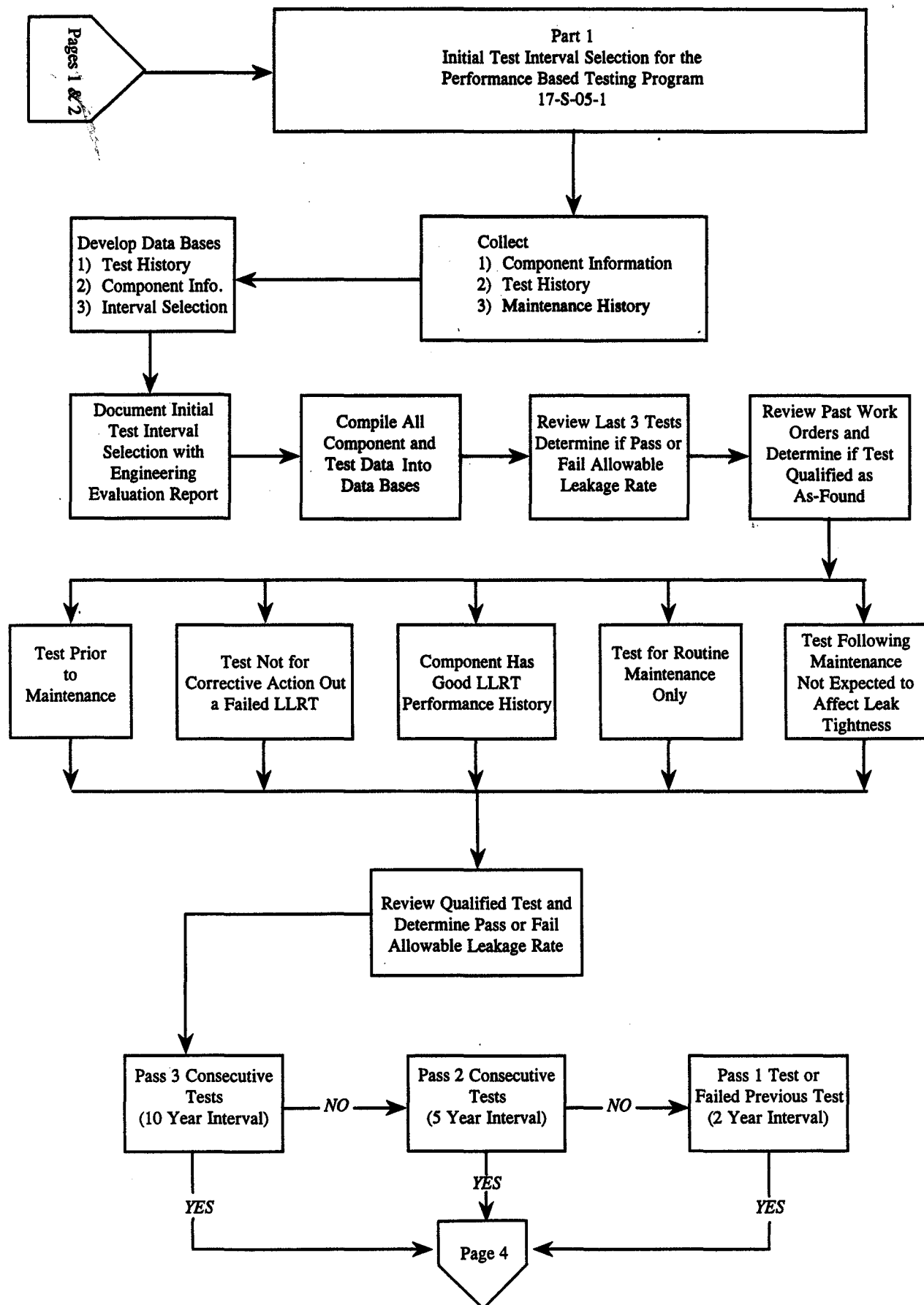

Figure F-1. Schematic of Performance-Based Program Process (Continued)

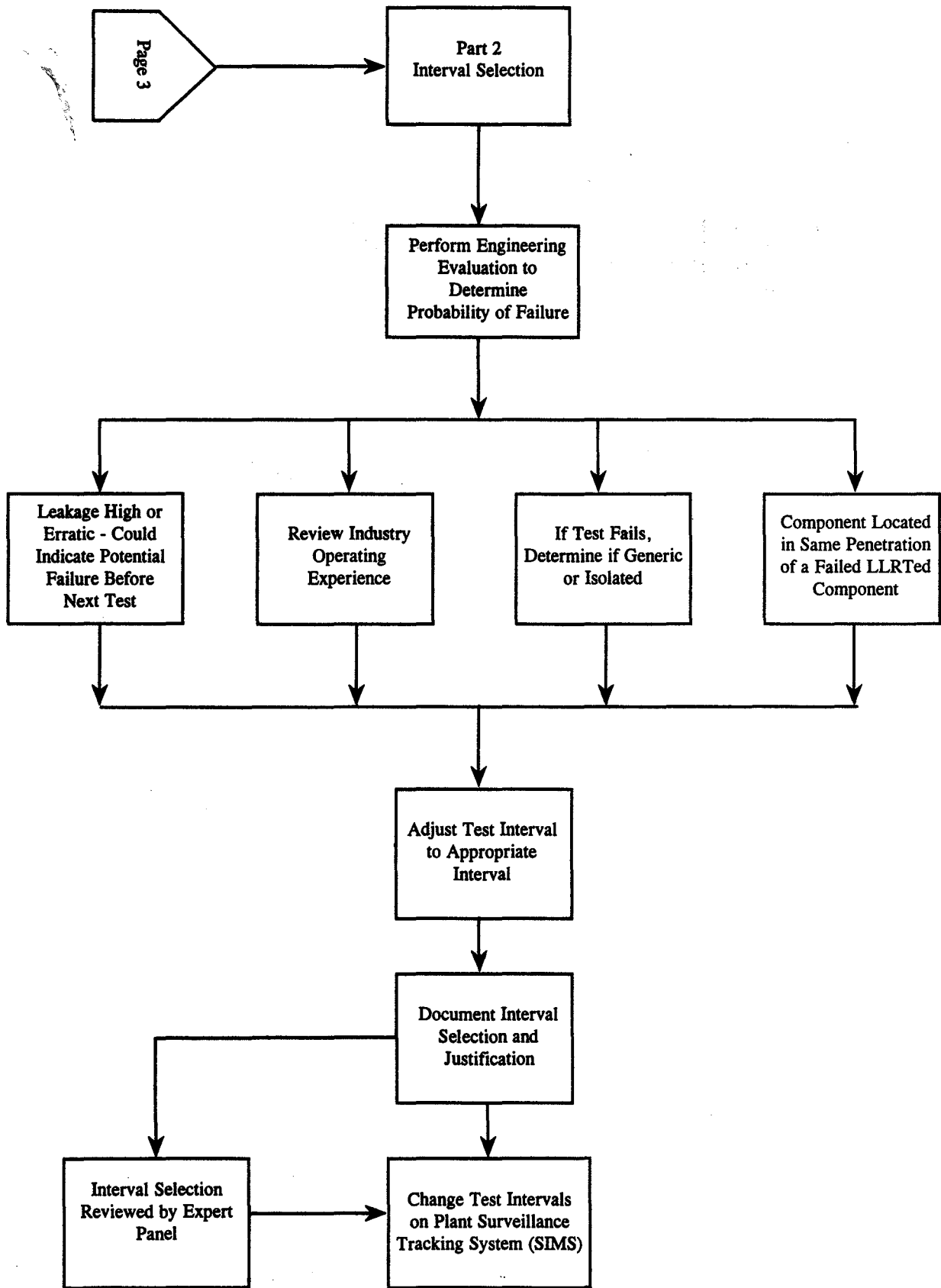

Figure F-1. Schematic of Performance-Based Program Process (Continued)

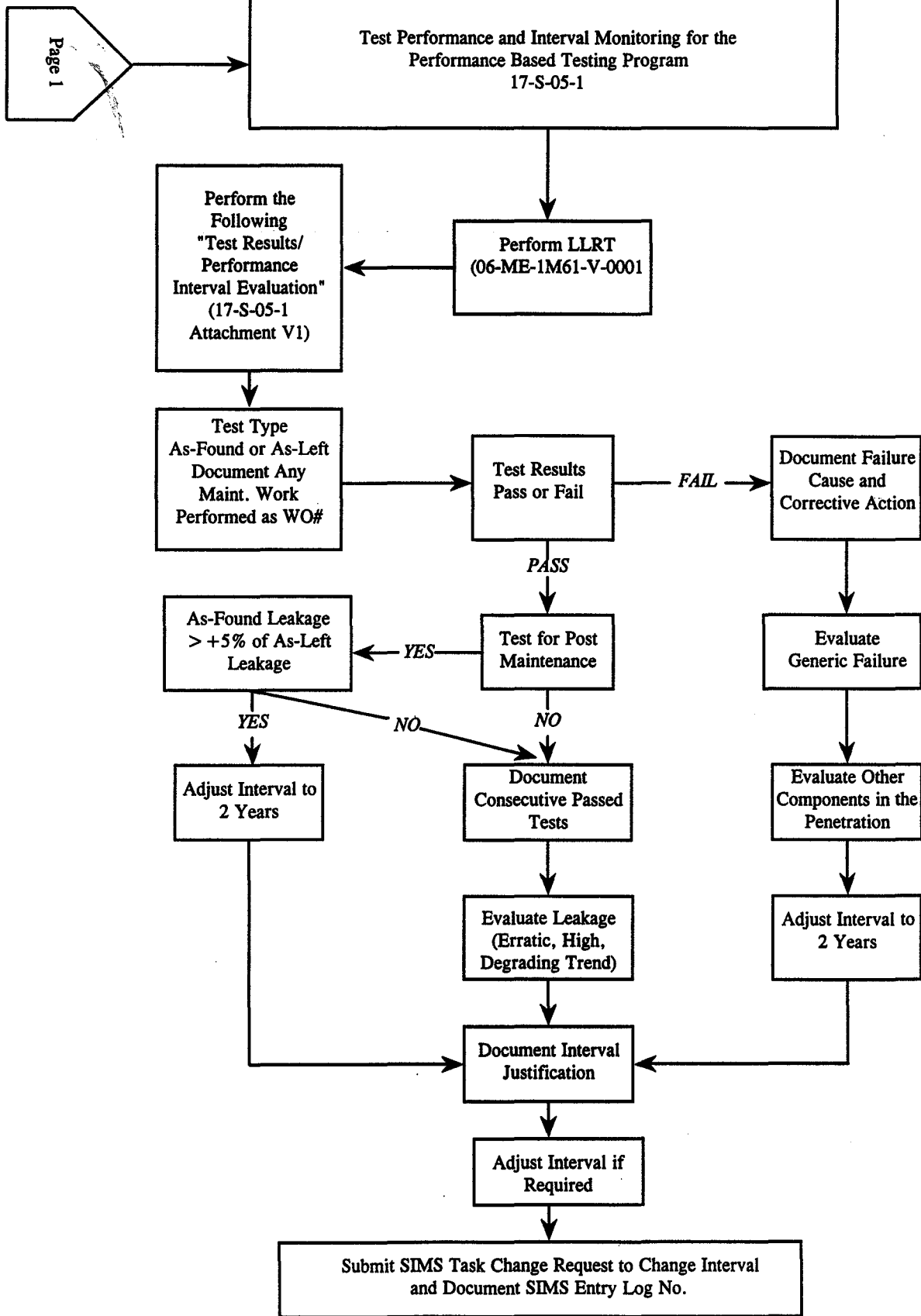

Figure F-1. Schematic of Performance-Based Program Process (Continued)

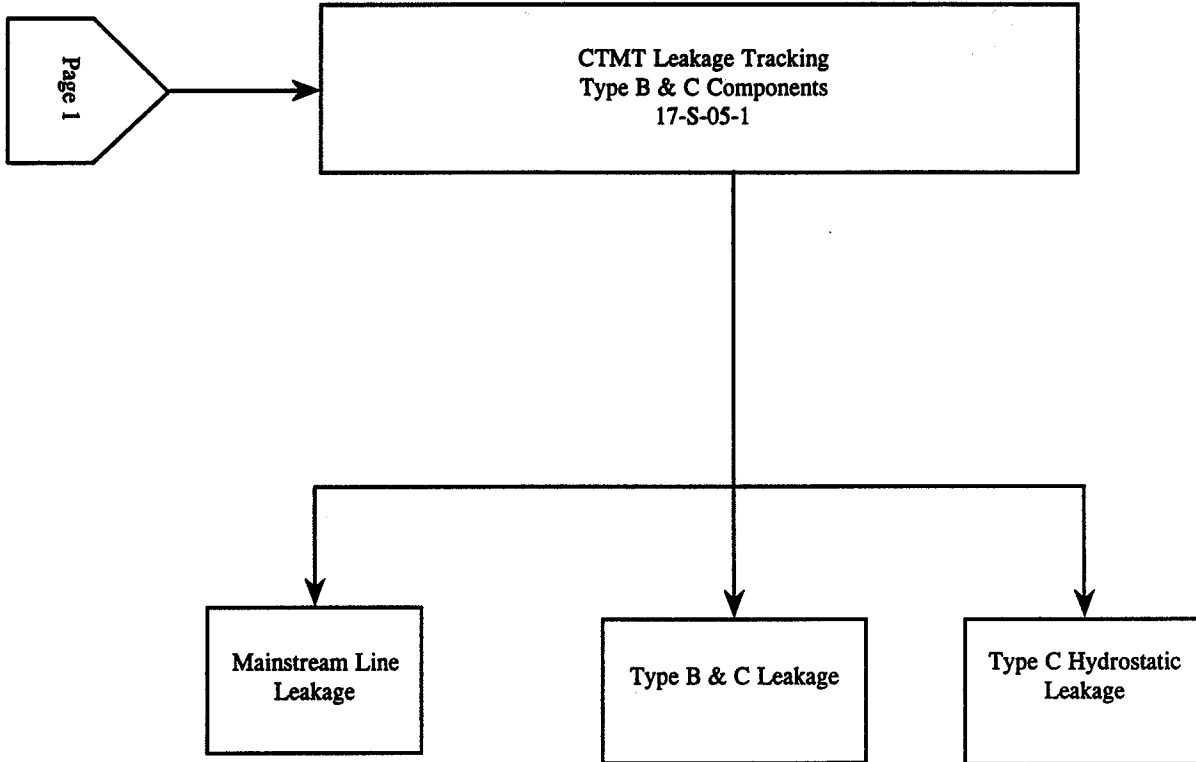

Figure F-1. Schematic of Performance-Based Program Process (Continued)

Table F-1. Comparison of Performance-Based and Prior Test Programs

Activity	Prior Program	Performance-Based Program	Total Components
ILRT	Every 40 months	Every 10 years	1
CTMT & Drywell Visual Inspection	Prior to ILRT	Every 40 months	1
CTMT Air-lock Barrel Tests	Every 6 months	Every 2 years. The air-lock relief valve and flange will be tested on the same frequency.	6
CTMT Air-lock Seal Tests	Every 72 hours	Every month	2
Type B Components (Electrical penetrations, flanges, guard pipes, access ports)	Every 2 years	Interval based on performance (the number of consecutively-passed tests) and engineering judgement. - Passed 1 test or failed previous test - Test every 2 years - Passed 2 tests - Test every 5 years	98
Type C Components (CTMT isolation valves)	Every 2 years	Interval based on performance (the number of consecutively-passed tests) and engineering judgement. - Passed 1 test or failed previous test - Test every 2 years - Passed 2 tests - Test every 5 years	152
Mainsteam & Feedwater Isolation Valves	Every 2 years	No change - These valves were determined to have potential safety significance that would require further evaluation prior to extending their test intervals.	16
Pre-Maintenance As-Found Testing	Every ILRT outage	Always required for the 250 components in the Performance-Based Testing Program.	N/A
CTMT Purge Valves	Every 30 days	No change	8
Fixed-Frequency Components	Every 2 years	No change - These components are the CTMT Equipment Hatch and Fuel Transfer Gate. Both components will be removed each outage, therefore extending the interval would be of no benefit.	2
Pressure Isolation Valve Tests	Every 18 months	No change - These tests are required per technical specifications and are not Appendix J tests.	24
Drywell Bypass Test	Every 18 months	Every 5 or 10 years	1
Drywell Air-lock Tests	Every 18 months	No change	4
Drywell Air-lock Test Tubing Drop Test	Every 18 months	Requirements moved to the FSAR. A 50.59 is being written to possibly eliminate the test or relax the acceptance criteria.	1
CTMT Air-lock Tubing Drop Tests	Every 18 months	No change	2

not less than $1.10 P_a$. Overall air-lock leakage shall be less than or equal to 2 scfh at a pressure equal to or greater than P_a . Pressure isolation valves shall be limited to a leakage rate of less than 1 gpm at a reactor coolant pressure between 1040 and 1060 psig. Provisions exist for testing at lower pressure differentials provided requirements are met. Purge supply and exhaust isolation valves shall not exceed $0.01 L_a$. The leakage rates noted in the preceding for individual components may be exceeded provided the overall Type B & C limits are maintained.

F.5 DATA ANALYSIS

The procedure identifies those instances where data analyses are required to ascertain the reason(s) why an acceptance limit was exceeded during a test, and specifies when and which corrective actions are necessary. The procedure also allows a test to be repeated, in lieu of the foregoing, as determined by the supervisor in charge.

F.6 TEST FREQUENCIES

Local leakage-rate testing for Type B & C valves and penetrations shall be performed at intervals based on the performance of each component. Testing history will be evaluated and intervals adjusted in accordance with defined criteria. Test vent and drain valves, pressure isolation valves, vent and purge valves, two-year interval components and fixed two-year interval components are excluded from the performance-based testing program.

Test intervals shall be established by reviewing the last three consecutive Type B/C tests performed and by determining if each component had passed or failed. A failure is a test that exceeded the allowable leakage limit. Consecutive means a test must be performed in sequence at least 12 months apart with a minimum of 12-months inservice time before the test. If retest data are used to extend the test

interval, criteria and restrictions apply and are specified in the instruction. The initial interval selection will be reviewed and approved by an expert panel.

The test interval for Type B and C components shall be as follows: every two years for components that pass one test or that have failed the previous test and every five years for components that pass two consecutive tests. A review of all consecutively-passed tests will be performed to determine if the leakage was high, erratic or indicative of a degrading trend. High or erratic leakage could indicate a potential failure prior to the next scheduled Type B/C test. In order to evaluate the probability for failure the responsible engineer will consider the following information:

- Past failures - To determine if the component had failed a previous Type B/C test, if the failure was catastrophic (greater than $0.60 L_a$) and if the appropriate corrective action was taken to avoid recurrence.
- Component application\Usage factor - To determine if the component is normally open, normally closed, used for system isolation, used for flow control, or used in any way that could induce a higher wear rate.
- System function - To determine if the component is in a system that is used for normal unit operation, such as main steam, feedwater, etc. and could induce a higher wear rate.
- Component size - To determine if the size of the component has any effect on probability of failure or increases the consequences of failure.

• Operation medium - To determine if the component is in an operating medium that could induce a higher wear rate.

Industry operating experience is reviewed to identify any generic problems including those associated with containment isolation valves and other components subject to Appendix J testing. Any generic problems identified will prompt a review to determine if the problem could affect the Type B/C test performance of any component(s). If the problem could affect test performance, an evaluation will be done and the test interval will be adjusted to an appropriate interval. The problem will be monitored until it is resolved or until the problem is corrected.

A review will be performed on each failure to determine if the failure was generic or isolated. If it is determined that the failure was generic, all other components that are subject to the same failure mechanism will be adjusted to an appropriate interval. All components located in a penetration of a failed component will be evaluated for placement in the same interval as the failed component.

Following these procedures, Grand Gulf performed an engineering evaluation of the performance history all its containment penetrations, valves and components. This effort resulted in the development of a 60-page LLRT database which, along with other information, was used to determine initial testing intervals. A separate report provides all justifications and rationale for the selections made, which are themselves reviewed by an expert panel. Examples of the justifications provided for interval selection are:

"The LLRT on this valve was changed from a water test to an air test in 1993. Only 1 air test has been performed to date, therefore, the test interval is limited to 2 years until additional testing is performed."

"This component ... has a total allowable leakage rate of 30,289 ml/min. Therefore, leakage of 2700 ml/min is not considered high and does not indicate a potential failure. The 120 month test interval is acceptable. The LLRT performed in 1990 was a retest for scheduled maintenance activities and was not for corrective action of a failed LLRT. This test was used in the interval selection process per the guidelines.... Although this set of LLRTs meets the criteria for 10-year interval selection, the last 3 tests results display an apparent trend of increasing leakage. Test interval will be kept at 60 months until the trend is better defined, the trend stops increasing, or corrective action is taken." [Note that subsequent to this evaluation, the NRC approved a one-time exemption to Appendix J requirements, allowing up to a 5-year LLRT test interval for Type C valves.]

F.7 REPAIR, REPLACEMENT AND MAINTENANCE

An as-found Type B/C test, as appropriate, will be performed prior to any maintenance or modification activity performed on a component if the activity could affect the component's leak-tightness. Components remaining on 2-year intervals will not require as-found testing during outages during which a Type A test is not performed.

Each maintenance or modification activity that could affect the component's leak-tightness is followed by a Type B/C test after the completion of the activity. If the post-work Type B/C test leakage rate for extended interval components was not greater than +5% of the Type B/C test leakage rate performed prior to the maintenance or modification, and other applicable retests (such as tests required for the Motor Operated Valve Testing Program) are acceptable, re-establishment of component performance will not be required and the component will remain

on its current test interval. If the post-work Type B/C test leakage rate for extended interval components was greater than +5% of the Type B/C test leakage rate performed prior to the maintenance or modification, or other applicable retests were unacceptable, re-establishment of component performance is required and the test interval for the component will be adjusted to a 2-year interval. The test interval may be extended once satisfactory performance is re-established in accordance with the requirements of this program.

F.8 DATA PACKAGE REVIEW

The instruction provides requirements for review of the data package supporting the results of the testing.

F.9 GENERAL REQUIREMENTS FOR TYPE B & C TEST RESULTS

During refueling or maintenance outages when Type B & C testing is performed before a Type A test, the Type A test results shall be adjusted for any repairs or adjustments made so that the As-Found condition of the containment can be properly determined and evaluated. As-Left leakages are permitted during certain refueling outages in accordance with conditions specified in the instruction. Specific data recording needs are identified for Type B & C test results during refueling outages and during power operation; for main steam line isolation valve leakage, and hydrostatically-leakage-tested valves.

F.10 DATA TRENDING AND ANALYSIS

If a trend of increasing valve leakage rates is evident or suspected, it may be appropriate to analyze data for adverse trends. The procedure recommends a step-by-step method for conducting such analyses.

1

BIBLIOGRAPHIC DATA SHEET

(See instructions on the reverse)

1. REPORT NUMBER
(Assigned by NRC, Add Vol.,
Supp., Rev., and Addendum Num-
bers, if any.)

NUREG-1493

2. TITLE AND SUBTITLE

Performance-Based Containment Leak-Test Program

Final Report

3. DATE REPORT PUBLISHED

MONTH	YEAR
September	1995

4. FIN OR GRANT NUMBER

5. AUTHOR(S)

M. Dey/NRC
L. Skoblar, P. Chen, D. Goldin/SC&A¹
P. Cybulskis, L. Minton, S. Rose/Battelle²
W. Roman/SPC³

6. TYPE OF REPORT

Final

7. PERIOD COVERED (Inclusive Dates)

8. PERFORMING ORGANIZATION - NAME AND ADDRESS (if NRC, provide Division, Office or Region, U.S. Nuclear Regulatory Commission, and mailing address; if contractor, provide name and mailing address.)

Division of Regulatory Applications
Office of Nuclear Regulatory Research
U.S. Nuclear Regulatory Commission
Washington, DC 20555-0001

¹S. Cohen & Associates, Inc., 1355 Beverly Road, Suite 250,
McLean, VA 22101

²Battelle, 505 King Avenue, Columbus, OH 43201

³Southwest Power Consultants, Inc., 4935 E. Rancho Del Oro Drive,
Cave Creek, AZ 85331

9. SPONSORING ORGANIZATION - NAME AND ADDRESS (if NRC, type "Same as above"; if contractor, provide NRC Division, Office or Region, U.S. Nuclear Regulatory Commission, and mailing address.)

Same as above

10. SUPPLEMENTARY NOTES

Report is a technical, support document for revision to 10 CFR Part 50, Appendix J, "Containment Leakage Testing."

11. ABSTRACT (200 words or less)

The Nuclear Regulatory Commission (NRC) is implementing an initiative to eliminate requirements that are marginal to safety and yet impose a significant regulatory burden on licensees. The containment leak-testing requirements for power reactors have been identified as one area where performance-based requirements could replace the current prescriptive requirements with only a marginal impact on safety. This technical support document (TSD) provides the technical bases for the NRC's rulemaking to revise leak-testing requirements for nuclear power reactors in 10 CFR Part 50, Appendix J. This report identifies alternatives to current containment testing requirements which would meet the NRC's Safety Goals and achieve greater efficiency in the use of resources. Changes in the allowable leak rate for containment and the testing frequencies for both integrated and local leak rate tests are evaluated in terms of both risk and cost impacts. The feasibility of applying statistically-based sampling techniques to local leak-rate testing, and the use of on-line monitoring systems to continuously monitor containment integrity are also evaluated.

12. KEY WORDS/DESCRIPTORS (List words or phrases that will assist researchers in locating the report.)

Reactor
Containment leakage testing
Risk-based regulation
Regulatory review and improvement
Elimination of requirements marginal to safety
Performance-based regulations

13. AVAILABILITY STATEMENT
Unlimited

14. SECURITY CLASSIFICATION
(This Page)
Unclassified
(This Report)
Unclassified

15. NUMBER OF PAGES

16. PRICE

